



*Personal Computer
Hardware Reference
Library*

IBM RT PC Guide to Operations

SA23-2607-0

The following statement applies to this IBM product. The statement for other IBM products intended for use with this product will appear in their accompanying manuals.

Federal Communications Commission (FCC) Statement

Warning: This equipment generates, uses, and can radiate radio frequency energy and if not installed and used in accordance with the instructions manual, may cause interference to radio communications. It has been tested and found to comply with the limits for a Class A computing device pursuant to Subpart J of Part 15 of FCC Rules, which are designed to provide reasonable protection against such interference when operated in a commercial environment. Operation of this equipment in a residential area is likely to cause interference in which case the user at his own expense will be required to take whatever measures may be required to correct the interference.

Instructions to User: Properly shielded and grounded cables and connectors must be used for connection to peripherals in order to meet FCC emission limits. Proper cables are available from IBM authorized dealers. IBM is not responsible for any radio or television interference caused by using other than recommended cables or by unauthorized modifications to this equipment. It is the responsibility of the user to correct such interference.

Third Edition (June 1988)

This is a major revision of and obsoletes the second edition of *IBM RT PC Guide To Operations*.

This edition applies to all subsequent releases until otherwise indicated in new editions or technical newsletters. Changes are made periodically to the information herein; these changes will be incorporated in new editions of this publication.

References in this publication to IBM products, programs, or services do not imply that IBM intends to make these available in all countries in which IBM operates. Any reference to an IBM licensed program in this publication is not intended to state or imply that you can use only IBM's licensed program. You can use any functionally equivalent program instead.

International Business Machines Corporation provides this manual as is, without warranty of any kind, either expressed or implied, including, but not limited to, the implied warranties of merchantability and fitness for a particular purpose. IBM may make improvements and/or changes in the products and/or the programs described in this manual at any time.

Products are not stocked at the address given below. Request copies of this product and technical information about the system from your retail outlet or IBM representative.

A reader's comment form is provided at the back of this publication. If the form is missing, address your comments to IBM Corporation, Department 997/998, 11400 Burnet Road, Austin, Texas 78758. IBM may use or distribute whatever information you supply in any way believed appropriate without incurring any obligation to you.

IBM is a registered trademark of the International Business Machines Corporation.

RT PC is a registered trademark of the International Business Machines Corporation.

©Copyright International Business Machines Corporation 1985, 1986, 1988. All rights reserved.

Statement of Limited Warranty

International Business Machines Corporation (IBM) gives you the following limited warranty for this IBM Machine. IBM gives you this limited warranty only if this Machine was originally purchased for use, and not resale, from an IBM Authorized Dealer, IBM Authorized Industry Remarketer or an IBM approved Reseller. The Dealer, Remarketer or Reseller must be authorized or approved by IBM to market this Machine. The Warranty Exhibit to this Statement identifies this Machine and specifies other important information. This Machine will be subject to this Statement of Limited Warranty only if purchased and located in the United States or Puerto Rico.

DEFINITIONS

The term "Remarketer" shall mean an IBM Authorized Dealer, IBM Authorized Industry Remarketer or IBM approved Reseller for this Machine unless the context requires individual reference.

The term "Machine" shall mean a machine and/or its features, model conversions, machine elements and accessories unless the context requires individual reference.

The term "failing machine" shall mean a machine or machine element requiring warranty service as initially determined by you and, as applicable, verified by IBM.

The term "exchange machine" shall mean a machine or machine element provided to you by IBM under an Exchange Type of Service.

LIMITED WARRANTIES

A Machine subject to this Statement of Limited Warranty will be 1) newly manufactured by or for IBM from new and serviceable used parts which are equivalent to new in performance in the Machine, 2) assembled by or for IBM from serviceable used parts, or 3) a Machine which has been previously installed.

IBM warrants that on this Machine's Date of Installation it will be in good working order and will conform to IBM's official published specifications. IBM will make these specifications available to you upon request.

The Warranty Period for this Machine commences on its Date of Installation. The Warranty Period duration is specified in the Warranty Exhibit. If the Warranty Period expires on a Friday or Saturday, IBM will extend the Warranty Period so that its last day will be the following Sunday.

IBM or a Remarketer will notify you of the Date of Installation. IBM reserves the right to correct any error in such date.

Service and Parts Warranty

IBM agrees to provide the availability of warranty service for the duration of the Warranty Period at no additional charge except as set forth in this Statement. IBM will provide warranty service, as required, by 1) repairing this machine, model upgrade or feature addition or 2) exchanging the machine or machine element. IBM will render repair or exchange under one of the Types of Service described in this Statement. IBM will specify the specific Type of Service for this Machine during its Warranty Period in the Warranty Exhibit. For certain Machines, IBM offers a Warranty Option that provides an alternate method of obtaining warranty service under another Type of Service. Any such Warranty Option is available under the IBM Maintenance Agreement.

IBM shall have full, free and safe access to this Machine to provide On-Site Types of Service. You shall promptly inform IBM of any change in this Machine's location during its Warranty Period.

You are responsible to initially determine that the machine or machine element requires warranty service. Before requesting such service, you shall follow IBM's problem determination, problem analysis and service request procedures.

You are responsible to remove and control funds contained in a Machine. IBM will service a Machine containing funds only when you cannot open the cash container. If so, you will remove the funds as soon as the container is, or can be, opened. IBM will render a Repair or Exchange Type of Service only when you present a failing machine to IBM.

Under a Repair Type of Service, IBM will provide remedial maintenance to restore the Machine to good working order. IBM may also provide preventive maintenance based on the specific needs of the Machine as determined by IBM. IBM may also lubricate, adjust and replace parts when IBM considers it necessary. IBM will install parts, which may be used parts, on an exchange basis. IBM will acquire title to the replaced parts. You are responsible to remove or protect all programs, data and removable storage media before IBM repairs the Machine.

Under an Exchange Type of Service, IBM will provide an exchange machine which may not be new but will be in good working order. You will acquire title to it at the time of exchange. IBM will acquire title to the failing machine at the time of exchange. IBM reserves the right to verify that a failing machine is acceptable for exchange. You are responsible to remove all non-IBM parts, options, alterations and attachments before you present a failing machine for exchange. You give up all rights to any such items not removed. You will not present IBM a failing machine for exchange which is defaced, altered, in need of a repair not included in warranty service, or damaged beyond repair. IBM will inspect the failing machine to determine if the failing machine is in such condition. If so, IBM will nullify the exchange and each party will return to the other the machine or machine element in its possession. You will ensure that a failing machine is free of any encumbrances at the time you present it to IBM under an Exchange Type of Service.

The Period of Warranty Service is 24 hours a day, 7 days a week for IBM On-Site Types of Service. The Period of Warranty Service for all other Types of Service is the normal business hours of the IBM designated location.

If you request, and IBM provides, an On-Site Type of Service in place of the Type of Service then in effect, you shall pay IBM's then generally available charge for the service provided.

Warranty service does not assure uninterrupted operation of this Machine.

During the Warranty Period, IBM will control and install engineering changes IBM determines to be applicable to this Machine. You may, by providing notice subject to IBM's written confirmation, elect to have only IBM designated mandatory engineering changes installed on this Machine.

Types of Service

IBM On-Site Repair (IOR)

IBM will provide warranty service for the failing machine at your location.

IBM On-Site Exchange (IOE)

IBM will 1) deliver the exchange machine to your location, 2) disconnect the failing machine, 3) connect the exchange machine, 4) verify its operation, and 5) remove the failing machine from your location.

Customer On-Site Exchange (COE)

IBM will have an exchange machine delivered to your location. You will 1) disconnect the failing machine and prepare it for shipment to IBM, 2) connect the exchange machine, and 3) verify its operation. You will follow IBM's instructions regarding shipment of the failing machine to IBM. IBM will pay the shipment expense.

Customer Carry-In Repair (CCR)

You will 1) deliver the failing machine to an IBM designated location, 2) pick up the machine or machine element, following any repairs, and take it to your location, 3) connect it, and 4) verify its operation.

In place of such delivery and pickup, you may ship the failing machine, prepaid, in the original shipping container, or equivalent, to an IBM location designated to receive such shipment. Following any repairs, IBM will ship the machine or machine element to your location, prepaid, within the United States or Puerto Rico.

Customer Carry-In Exchange (CCE)

You will 1) deliver the failing machine to an IBM designated location, 2) pick up the exchange machine and take it to your location, 3) connect it, and 4) verify its operation.

In place of such delivery and pickup, you may ship the failing machine, prepaid, in the original shipping container, or equivalent, to an IBM location designated to receive such shipment. Following receipt of the failing machine, IBM will ship the exchange machine to your location, prepaid, within the United States or Puerto Rico.

You are responsible for risk of loss of, or damage to, the Machine during the period such Machine is in transit to and from IBM. However, IBM is responsible for risk of loss of, or damage to, 1) IBM-owned Machines and/or 2) a Machine owned by other than IBM while in IBM's possession or in transit from IBM to you by an IBM-selected carrier whose charges IBM prepays. In addition, IBM is responsible for loss or damage due to IBM's negligence.

Additional Provisions for Features and Model Conversions

IBM's warranty for each feature addition or model upgrade requires that the machine on which such addition or upgrade is installed meets certain conditions. The machine must 1) be at a proper engineering-change level, as IBM determines, 2) be the specific serial-numbered machine for which you ordered such addition or upgrade, and 3) have been modified only with changes obtained from IBM specifically for that serial-numbered machine. If these conditions are not met, IBM will attempt to install a non-CSU feature addition and/or model upgrade on the machine. If such attempt results in a correctly functioning machine, this Statement will apply. If such attempt results in an incorrectly functioning machine, upon your request, IBM will remove the feature addition and/or model upgrade and restore the machine to its prior condition. In such case, IBM will invoice you IBM's generally available charges, including travel expenses. If the feature addition or model upgrade did not involve the removal of parts which became IBM's property, such feature addition or model upgrade remains your property. If the feature addition or model upgrade involved the removal of parts which became IBM's property, such feature addition or model upgrade becomes IBM's property and the restored parts become your property.

IBM will provide a three-month parts warranty for additional parts supplied by IBM for a feature removal, model downgrade or reinstallation of a previously purchased feature or model conversion.

Additional Provisions for Machine Elements and Accessories

A machine element, which you separately purchased, or an accessory has a three-month Warranty Period unless IBM specifies a longer duration. During the Warranty Period, you will remove any such machine element or accessory which fails in normal use. You will then ship it, prepaid, to the IBM location designated to receive such shipment. IBM will repair or replace, at its option, such machine element or accessory. IBM's shipment to you will be prepaid within the United States or Puerto Rico.

Travel Expense

There will be no additional charge for travel expense associated with warranty service except when the site at which the Machine is located is inaccessible to the IBM service representative by both private automobile and scheduled public transportation.

Services for Additional Charge During the Warranty Period

Warranty service does not include repair of certain Machine failures. These failures are those which are caused by an unsuitable environment, accident, disaster, transportation, vandalism, misuse, abuse, another product or device not under IBM warranty or IBM agreement service, non-IBM modification, or service of the Machine by other than IBM. In addition, warranty service does not include inspection of the Machine, including inspection of an altered Machine, or repair of damage caused by use of, inadequate use of, or failure to use, supplies. If service not included in warranty service is available, and IBM provides such service, it will be provided for an additional charge. IBM shall determine such charge by using IBM's 1) then generally available hourly service rates and minimum charges for service time, including travel and waiting time, 2) parts and material prices then generally in effect, and 3) charges for travel and shipping expense, all as applicable.

Other Warranty Provisions and Exclusions

This limited warranty does not include any service which is impractical for IBM to render because of alterations in, or attachments to, this Machine. IBM will replace a part not provided by IBM for this Machine only with a directly interchangeable IBM part. If so, IBM will charge you as described in the preceding paragraph. IBM will not replace any part which is included in an alteration.

If you transfer this Machine to another user, IBM will provide the availability of warranty service under this Statement to that user. Such warranty service will be available for the remainder of the Warranty Period. Therefore, you should transfer the proof of purchase and this Statement to that user.

THE FOREGOING WARRANTIES ARE IN LIEU OF ALL OTHER WARRANTIES, EXPRESS OR IMPLIED, INCLUDING, BUT NOT LIMITED TO, THE IMPLIED WARRANTIES OF MERCHANTABILITY AND FITNESS FOR A PARTICULAR PURPOSE.

LIMITATION OF REMEDIES

Your sole remedy under this Statement of Limited Warranty is set forth in this Section. For any claim concerning performance or nonperformance by IBM, an IBM Authorized Dealer, or an IBM Authorized Industry Remarketer for this Machine under this Statement of Limited Warranty, you may recover actual damages up to the limit set forth in the following paragraph.

The limit of IBM's liability for actual damages to you for an individual event based on any cause whatsoever shall be the greater of 1) \$100,000 or 2) the amount you paid for the Machine which caused the damages. This limitation of liability will not apply to claims for personal injury or damage to real property or tangible personal property caused by IBM's negligence. In no event will IBM be liable to you for any damages caused by your failure to fulfill your responsibilities under this Statement of Limited Warranty. In no event will IBM be liable for any lost profits, lost savings, incidental damages, or other consequential damages. This is true even if you advised IBM or a Remarketer of the possibility of such damages. IBM is not liable for any claim by you based on any third party claim.

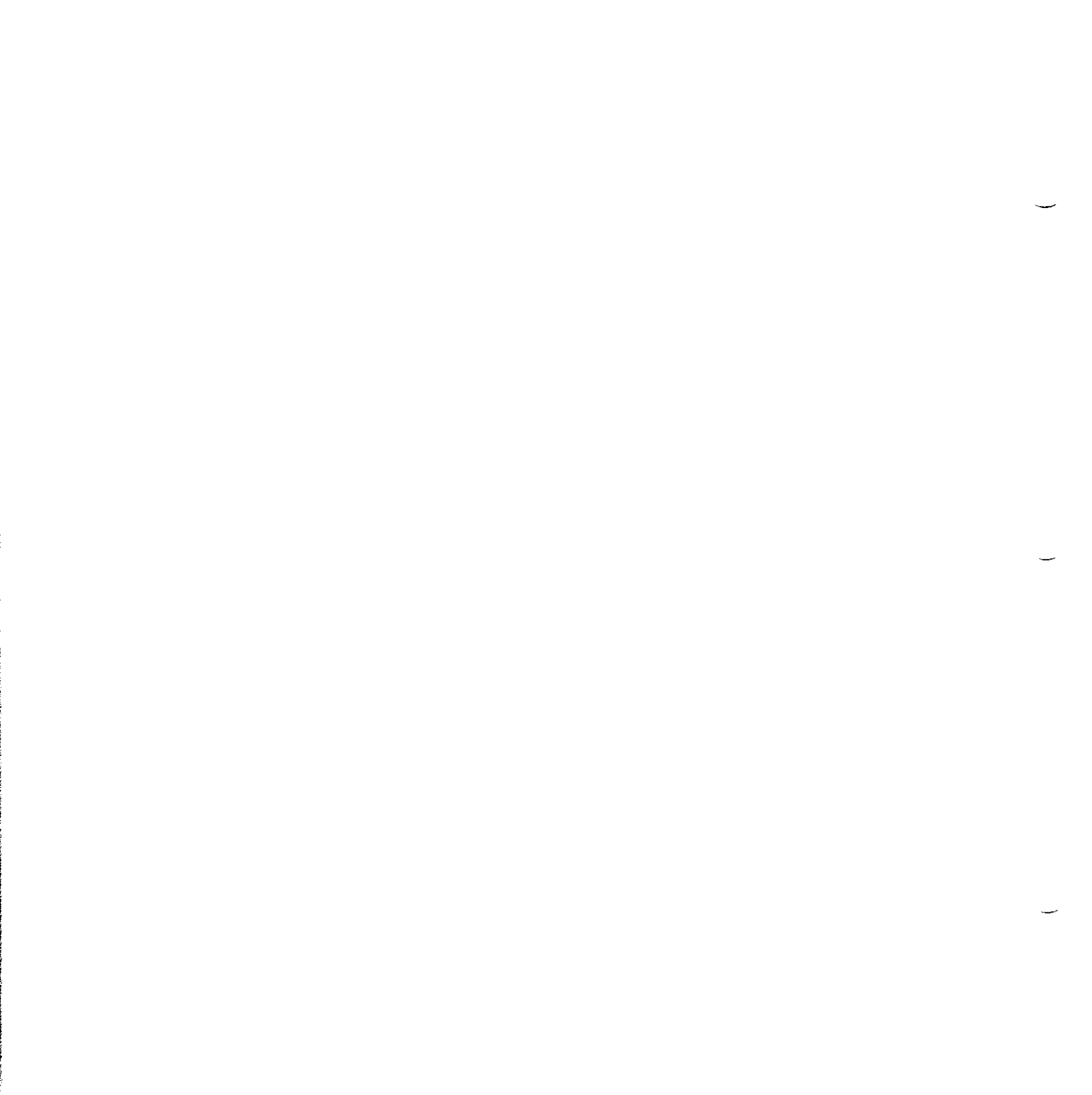

Danger

ENGLISH

DANGER

Caution

Before removing any cover or disconnecting any signal cable, set the power switches on the system unit and all attached devices to Off; then unplug all external power cables from the outlets.

Section 5

Moving the system - Instructions are given to turn off the power switch, unplug the power cables; the following note is written "CAUTION: two or more people should lift the IBM RT PC Model 6150 and Model 6151 System Unit, which weighs up to 42 Kg. Use a dolly if possible"

Page 5-9

CAUTION: Do not lift the IBM 5081 Display by yourself.

Danger (continued)

FINNISH

VAROITUS

Huomio

Ennen minkään yhteyskaapelin tai kannen irrottamista, katkaise virta systeemyksiköstä ja kaikista siihen liitetyistä laitteista; irroita sitten kaikki verkkojohdot pistorasioistaan.

Luku 5

VAROITUS: IBM RT PC:n keskusyksikön, mallit 6151 ja 6150, nostamiseen tarvitaan vähintään kaksi henkilöä. Keskusyksikkö saattaa painaa jopa 42 kg. Käytä nostolavaa, mikäli mahdollista.

Sivu 5-9: VAROITUS: Älä nosta IBM 5081 -näytintä yksin.

Danger (continued)

FRENCH

DANGER

Attention!

Avant de retirer le carter de protection ou de débrancher les câbles de signalisation:

- Mettre en position hors tension tous les interrupteurs de l'unité et des périphériques.
- Débrancher tous les cordons d'alimentation de leur prise murale.

Sec. 5

ATTENTION: L'unité centrale des modèles 20 et 25 pèse 42 kg. Prévoir au moins deux personnes pour la déplacer. Utiliser un chariot, dans la mesure du possible.

Page 5-9

ATTENTION: Ne soulevez pas l'écran IBM 5081 seul.

Danger (continued)

GERMAN

ACHTUNG

Achtung

Vor dem Entfernen von Verkleidungen oder dem Trennen von Signalkabeln Netzschalter der Systemeinheit und aller angeschlossenen Geräte ausschalten. Dann alle Netzkabel aus den Netzsteckdosen ziehen.

Kapitel 5

Standortwechsel - Anweisungen zum Ausschalten des Geräts, abziehen der Netzkabel; das Kapitel enthält folgenden Hinweis: "Vorsicht - da die Systemeinheit sehr schwer ist (ca 42 kg), sollte sie stets von mindestens 3 Personen angehoben werden. Nach Möglichkeit einen Transportkarren benutzen"

Seite 5-9

VORSICHT! Der Bildschirm IBM 5081 sollte nicht von einer einzelnen Person getragen werden.

Danger (continued)

ITALIAN

PERICOLO

Attenzione

Prima di togliere qualsiasi coperchio o scollegare qualsiasi cavo di segnale, spegnere gli interruttori di alimentazione dell'unità di sistema e di tutti i dispositivi collegati; scollegare poi dalle prese di corrente tutti i cavi di alimentazione esterni.

Sez. 5

AVVERTENZA: Per sollevare l'unità di sistema del PC RT IBM modello 20 e/o modello 25, che può pesare fino a 42 chili, sono necessarie due o più persone. Usare un carrello, se possibile.

Pag. 5-9

PERICOLO - Non sollevare da soli il video IBM 5081.

Danger (continued)

JAPANESE

危険

注意：

カバーを取り外したり、信号ケーブルを切り離したりする場合には、必ずシステム装置の電源スイッチとすべての接続装置の電源スイッチをオフにしてから、すべての外部電源ケーブルをコンセントから抜いてください。

注意

6150-20型および25型は42 Kgくらいになりますので、2人以上で持ち上げるようにしてください。台車があれば、それを使ってください。

一人で5081表示装置を持ち上げないでください。

Danger (continued)

NORWEGIAN

ADVARSEL

Advarsel

Før du tar av dekselet eller trekker ut signalkabler, må du slå av nettbryterne på systemenheten og alle tilkoblede enheter (AV, Off eller O) og trekke ut alle nettkablene fra stikkontaktene.

Kapittel 5

Flytting av maskinen - Brukeren får beskjed om å slå av nettbryteren og kople fra nettkablene.

“ADVARSEL: Man bør være minst tre for å bære systemenheten til 6150 og 6151, da de veier inntil 42 kilo. Bruk en tralle hvis du har”

Side 5-9

“ADVARSEL: Ikke løft skjermen (IBM 5081) alene”

Danger (continued)

PORTUGUESE

PERIGO

Cuidado

Antes de remover qualquer tampa ou de desligar qualquer cabo de sinal coloque os interruptores de corrente eléctrica da unidade do sistema e de todos os dispositivos a ela ligados na posição de desligado (off) e desligue das tomadas todos os cabos externos de corrente eléctrica.

Secção 5

CUIDADO - A Unidade do Sistema IBM RT PC Modelo 6150 e 6151, que pesa cerca de 42 Kg deve ser levantada por duas ou mais pessoas. Use, se possível, uma plataforma levadiça.

Páginas 5-9

CUIDADO - Não levante, sozinho, o Display IBM 5081.

Danger (continued)

SPANISH

PELIGRO

Precaucion

Antes de quitar cualquier cubierta o desconectar cualquier cable de seál, coloque los interruptores de alimentación en la unidad del sistema y en todos los dispositivos conectados en posición de APAGADO; desenchufe entonces todos los cables externos de alimentación de las tomas de corriente.

Sez. V

PRECAUCION - Este dispositivo es pesado. Se deberían levantar la unidad central entre tres o más personas. Su peso es superior a 42 kg (92 lb). Utilice un elevador a ser posible.

Pag. 5-9

ATENCION - No intente levantar solo el Monitor IBM 5081.

Danger (continued)

SWEDISH

VARNING

Varning

Innan du tar bort någon kåpa eller lossar någon signalkabel måste du slå från strömbrytarna på systemenheten och alla anslutna enheter samt lossa alla nätkablar från sina uttag.

I kapitel 5, "Moving the system", finns följande varningstext:

VARNING - Två eller flera personer bör hjälpas åt att lyfta systemenheten som kan väga upp till 42 kg.

I samma kapitel, på sidan 5-9 , finns följande varningstext:

VARNING - Försök inte att ensam lyfta IBM 5081 Bildskärm.

About This Book

Purpose

This book describes the various IBM devices available for the IBM RT Personal Computer®. Procedures for the day-to-day use of the IBM RT PC® are also provided. Read this book to learn how to:

- Operate the IBM 6150 and 6151 system units
- Handle diskettes
- Use diskette drives, fixed-disk drives, the IBM RT PC Keyboard and the IBM RT PC Mouse
- Clean the IBM RT PC Mouse
- Operate the supported displays
- Describe additional input device
- Move the IBM 6150 and 6151 system units.

RT PC and RT Personal Computer are registered trademarks of International Business Machines Corporation.

RT is a trademark of International Business Machines Corporation.

Audience

This book is intended for anyone who uses the IBM RT PC. This book should be helpful to people who need introduction to the system.

How to Use This Book

This book provides instructions for operating the IBM 6150 and 6151 system units. Section 2 of the book describes the IBM RT PC Keyboard and IBM RT PC Mouse. Section 3 and 4 describe the displays and other devices that can be attached to the IBM RT PC system units. In addition, Sections 6-9 provide convenient location for operating instructions that come with printers, plotters, terminals, and the IBM 6157 Streaming Tape Drive.

For your convenience, each section can be located with tabs.

Organization

This manual contains the following sections:

Section 1, "Operating the IBM RT PC System," describes the operation of the IBM 6150 and the 6151 system units. This section also explains the operation of diskette drives and fixed-disk drives.

Section 2, "Using the Keyboard and Mouse," discusses the operation of the IBM RT PC Keyboard and IBM RT PC Mouse.

Section 3, "Using the Displays," describes the displays available for the IBM RT PC System and the controls associated with each display.

Section 4, "Using Other Input Devices," describes some of the different input devices that can be used on the IBM RT PC System.

Section 5, "Moving the System," discusses preparing the IBM 6150 and 6151 system units to be moved.

Section 6, "Printers," is provided for you to insert the printer guide to operations that is shipped with the printer.

Section 7, "Plotters," is provided for you to insert the plotter guide to operations that is shipped with the plotter.

Section 8, "Terminals," is provided for you to insert the terminal guide to operations that is shipped with the terminal.

Section 9, "IBM 6157 Streaming Tape Drive," Describes the streaming tape drive, and provides a place to insert the setup and operating instructions shipped with the drive.

Section 10, "IBM RT PC 6192 Expansion Unit" describes the expansion unit and provides a place to insert the setup and option installation instructions shipped with the expansion unit.

Section 11, "IBM 6156 Portable Disk Drive" describes the portable disk drive and provides a place to insert the setup and operating instructions shipped with the drive.

The glossary describes terms used in the book.

You can use this book in two ways:

- Read and work through it from the first section to the last one.
- Use the Table of Contents and the Index to locate particular topics.

A Reader's Comment Form is provided at the back of this book. Use the Reader's Comment Form at any time to give IBM information that may improve the book.

Related Publications

- *IBM RT PC Options Installation* provides instructions for installing optional adapters in IBM 6151 and IBM 6150 and installing fixed-disk and diskette drives in IBM 6150. (Packaged with *IBM RT PC User Setup Guide*)
- *IBM RT PC User Setup Guide* provides instructions for setting up and connecting devices to the system units. This book also gives procedures for testing the setup. (Packaged with *IBM RT PC Options Installation*)
- *IBM RT PC Problem Determination Guide* provides instructions for running diagnostic routines to locate and identify hardware problems. A problem determination guide for software and three high-capacity (1.2MB) diskettes containing the IBM RT PC diagnostic routines are included.
- *IBM RT PC Installing and Customizing the AIX Operating System* provides step-by-step instructions for installing and customizing the AIX Operating System™, including how to add or delete devices from the system and how to define device characteristics. This book also explains how to create, delete, or change AIX and non-AIX minidisks.
- *IBM RT PC Usability Services Reference* supplements *IBM RT PC Usability Services Guide* by including information on using all of the Usability Services commands. (Packaged with *Usability Services Guide*)
- *IBM RT PC Using the AIX Operating System* describes using the AIX Operating System commands, working with file systems, and developing shell procedures.
- *IBM RT PC Managing the AIX Operating System* provides instructions for performing such system management tasks as adding and deleting user IDs, creating and mounting file systems, and repairing file system damage.
- *IBM RT PC Exploring Usability Services* is an online tutorial for first-time users of the Usability Services. This tutorial simulates the user interface and shows how to use the keyboard

and the optional mouse, how to manipulate windows, and how to use files and directories.

- *IBM RT PC Streaming Tape Drive Setup and Operating Instructions* provides instructions for setting up and operating the IBM 6157 Streaming Tape Drive. This pamphlet also describes procedures for cleaning the recording head of the tape drive and handling tape cartridges.
- *IBM 6156 Portable Disk Drive Setup, Operations and Technical Information* provides instructions for setting up and operating the IBM 6156 Portable Disk Drive and the enclosure the drive slides into.

-
- *IBM 6156 Portable Disk Drive Hardware Maintenance and Service* provides instructions for the removal and replacement of the field replaceable parts, and it contains the part numbers for all of the field replaceable parts.

Ordering Additional Copies of This Book

To order additional copies of this publication (without program diskettes), use either of the following sources:

- To order from your IBM representative, use Order Number SBOF-1828.
- To order from your IBM dealer, use Part Number 22F9801.

A binder and tabs are included with the order.

Contents

Section 1. Operating the IBM RT PC System	1-1
About This Section	1-3
Introducing the IBM 6150 and IBM 6151	1-4
System Unit	1-5
Operator Panel	1-8
Diskettes	1-13
Diskette Drives	1-16
Fixed-Disk Drives	1-21
Section 2. Using the Keyboard and Mouse	2-1
About This Section	2-3
Introducing the Keyboard and Mouse	2-4
Keyboard	2-5
Mouse	2-23
Section 3. Using the Displays	3-1
About This Section	3-3
Introducing the Displays	3-4
IBM 5151 Personal Computer Display	3-5
IBM 5154 Personal Computer Enhanced Color Display	3-6
IBM 6153 Advanced Monochrome Graphics Display	3-11
IBM 6154 Advanced Color Graphics Display	3-12
IBM 6155 Extended Monochrome Graphics Display	3-13
IBM 5081 Color Graphics Display	3-14
Section 4. Using Other Input Devices	4-1
About This Section	4-3
IBM 5080 Dials Feature	4-4
IBM 5080 Lighted Program Function Keyboard Feature	4-5
IBM 5083 Tablet	4-6
Section 5. Moving the System	5-1
About This Section	5-3
Before the Move	5-4

What Type of Move Are You Making?	5-8
Short Distance Move	5-9
Packing for a Long Distance Move	5-11
Moving the IBM 5081 Color Graphics Display	5-15
Section 6. Printers	6-1
About This Section	6-3
Section 7. Plotters	7-1
About This Section	7-3
Section 8. Terminals	8-1
About This Section	8-3
Section 9. IBM 6157 Streaming Tape Drive	9-1
About This Section	9-3
IBM 6157 Streaming Tape Drive	9-4
Section 10. IBM RT PC 6192 Expansion Unit	10-1
About This Section	10-3
Introducing the IBM RT PC 6192 Expansion Unit	10-4
Section 11. IBM 6156 Portable Disk Drive Model 001 and Model 003	11-1
About This Section	11-3
Introducing the IBM 6156 Portable Disk Drive	11-4
Glossary	X-1
Index	X-5

Section 1. Operating the IBM RT PC System

CONTENTS

About This Section	1-3
Introducing the IBM 6150 and IBM 6151	1-4
System Unit	1-5
Declaration of Noise Emission Values for IBM 6150	1-6
Declaration of Noise Emission Values for IBM 6151	1-7
Operator Panel	1-8
Keylock	1-9
Ordering a Key and Keylock	1-10
Power On and Power Off	1-11
Two-Digit Display	1-12
Diskettes	1-13
Write-Protect	1-14
Diskette Care	1-15
Diskette Drives	1-16
About Diskette and Drive Compatibility	1-17
Operating the Diskette Drive	1-18
Fixed-Disk Drives	1-21

About This Section

This section describes the RT PC system units and includes information on diskette drives, fixed-disk drives, and the operator panel.

Read this section to become familiar with:

- Handling diskettes
- Ordering keys and keylocks
- Powering on the system
- Powering off the system.

Introducing the IBM 6150 and IBM 6151

The RT PC family includes the IBM 6150 and the IBM 6151 system units. The IBM 6150s are floor-standing system units and the IBM 6151s are table-top system units.

An IBM RT PC system consists of the system unit, a keyboard, and a display. A wide range of options are available, such as a mouse, IBM 6157 Streaming Tape Drive, printers, data communications, terminals, and color plotters.

The operation of the system unit, diskette drives, fixed-disk drives, and IBM 6157 Streaming Tape Drive is the same for IBM 6150 and IBM 6151. The IBM 6150 provides larger expansion capability than the IBM 6151.

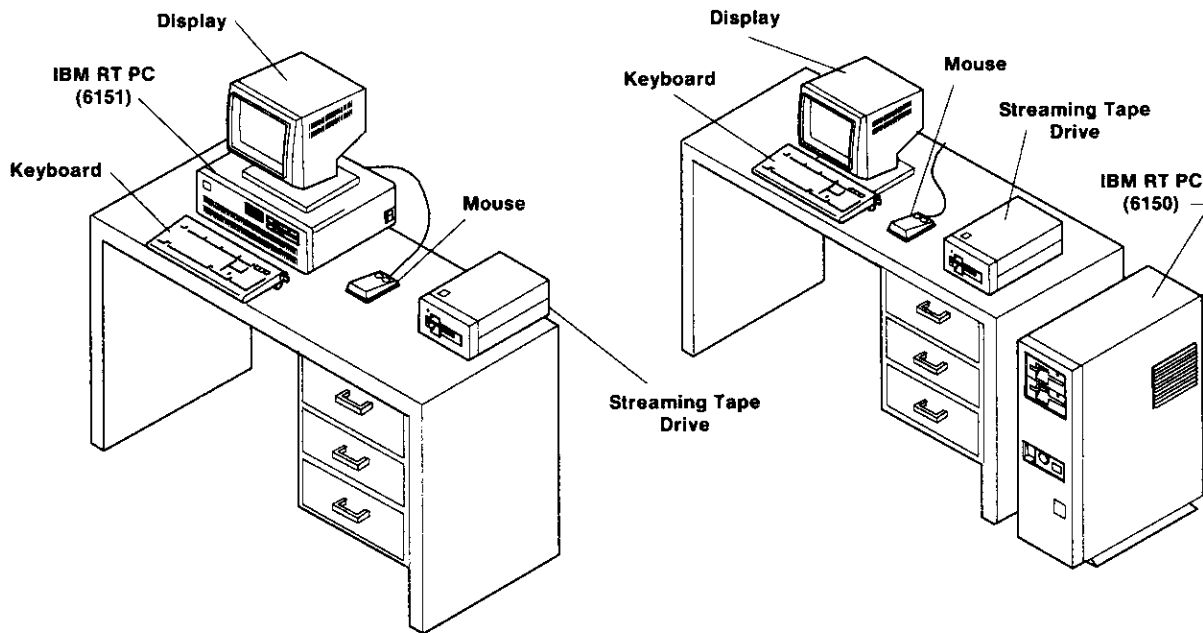

AS06A001

System Unit

The main component of the RT PC system is the system unit. The system unit contains hardware components such as memory or option cards and fixed-disk and diskette drives. These hardware components support the AIX Operating System. The AIX Operating System controls operations for the system and processes programs. Various program packages are available to help you meet a variety of application needs.

The AIX Operating System stores data on and retrieves data from the fixed-disk or diskettes using the system unit hardware.

See the publications for the AIX Operating System for additional information about installing and using the AIX Operating System.

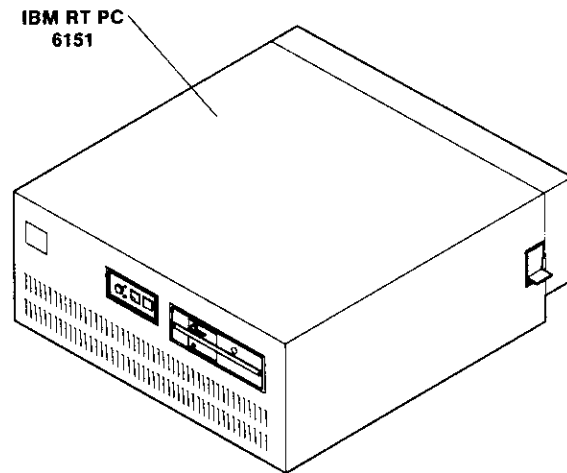
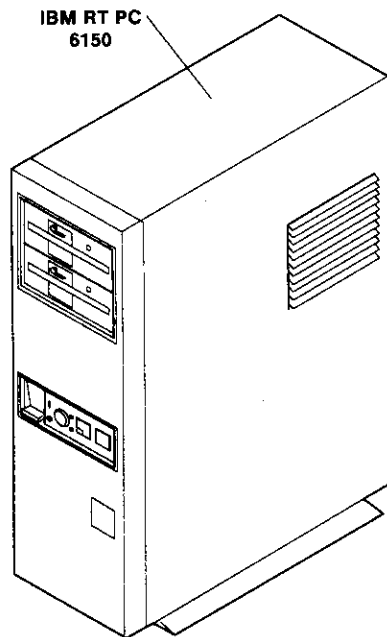

AS06A002

Declaration of Noise Emission Values for IBM 6150

The following chart describes the machine noise levels for IBM 6150. Stated noise levels are subject to change.

Product	
Type	Description
6150	System Console

L_{WAd}		L_{pAm}		$\langle L_{pA} \rangle_m$		Impulsive Noise	Prominent Discrete Tones
Operating (bels)	Idle (bels)	Operating (dB)	Idle (dB)	Operating (dB)	Idle (dB)	{ ΔLI }	
6.1	6.1	N/A	N/A	46.0	46.0	No	Yes

Notes:

1. L_{WAd} is the declared sound power emission level for a production series of machines.
2. L_{pAm} is the mean value of the sound pressure emission levels at the operator position (if any) for a production series of machines.
3. $\langle L_{pA} \rangle_m$ is the mean value of the space-averaged sound pressure emission levels at the one-meter positions for a production series of machines.
4. N/A = Not Applicable (No operator position).

All measurements are made in accordance with ISO DIS 7779, and reported in conformance with ISO DIS 7574/4.

Declaration of Noise Emission Values for IBM 6151

The following chart describes the machine noise levels for IBM 6151. Stated noise levels are subject to change.

Product	
Type	Description
6151	System Console

L_{WAd}		L_{pAm}		$\langle L_{pA} \rangle_m$		Impulsive Noise	Prominent Discrete Tones
Operating (bels)	Idle (bels)	Operating (dB)	Idle (dB)	Operating (dB)	Idle (dB)	{ ΔLI }	
6.0	6.0	51.0	51.0	46.0	46.0	No	Yes

Notes:

1. L_{WAd} is the declared sound power emission level for a production series of machines.
2. L_{pAm} is the mean value of the sound pressure emission levels at the operator position for a production series of machines.
3. $\langle L_{pA} \rangle_m$ is the mean value of the space-averaged sound pressure emission levels at the one-meter positions for a production series of machines.

All measurements are made in accordance with ISO DIS 7779, and reported in conformance with ISO DIS 7574/4.

Operator Panel

The operator panel is located on the front of the system unit. The panel consists of the keylock, power-on light, and two-digit display.

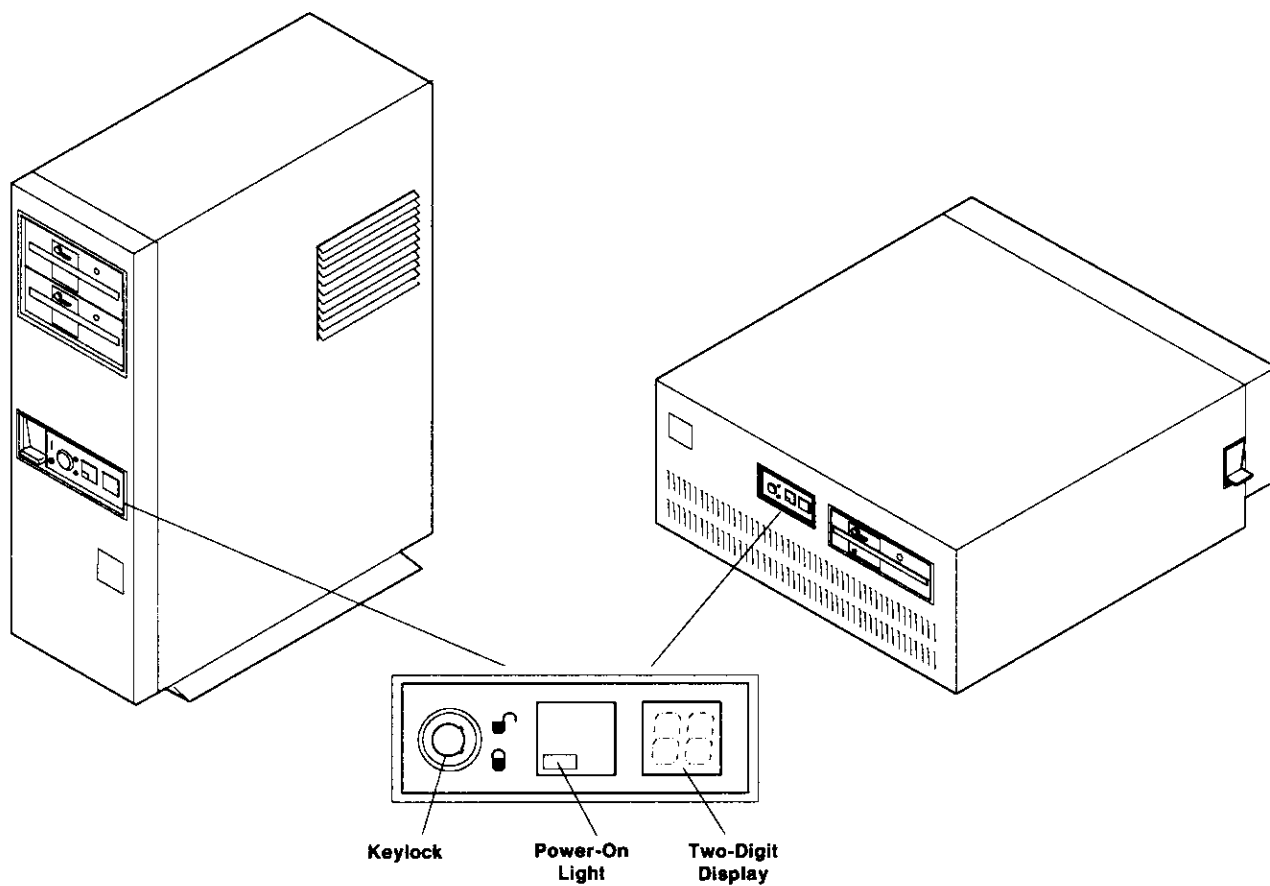

AS06A003

Keylock

The keylock helps prevent unauthorized use of the system. The keylock has an unlocked position and a locked position.

Locking the keylock deactivates the keyboard and locks the covers on. When you turn on the power switch while the keylock is in the locked position, the operation of the system unit stops and the two-digit display displays 99. You cannot use the keyboard or perform any further operations until the keylock is turned to the unlocked position.

When you unlock the keylock, the power-on procedure and program loading continues. When a program is loaded and operating correctly, you can lock the keylock at any time. Remote terminals will continue to operate.

You can lock the system whether the power is on or off. Turn the key clockwise to lock the system or counterclockwise to unlock it. You can remove the key from either position.

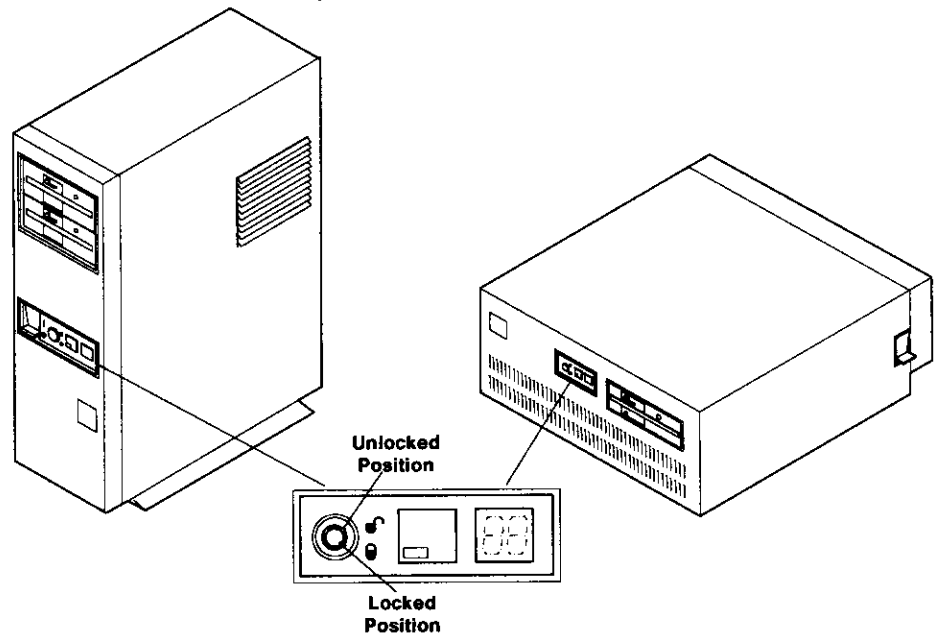

AS06A004

Ordering a Key and Keylock

Two keys were shipped with the system unit. If you have not separated the keys, rotate the top key and dislodge the keys. Keep the serial number tag in a safe place.

To obtain ordering and cost information for replacement keys or keylocks, consult your retail outlet or IBM representative. When ordering replacement keylocks include the keylock part number 6299485. When ordering replacement keys include the key serial number located on the serial number tag.

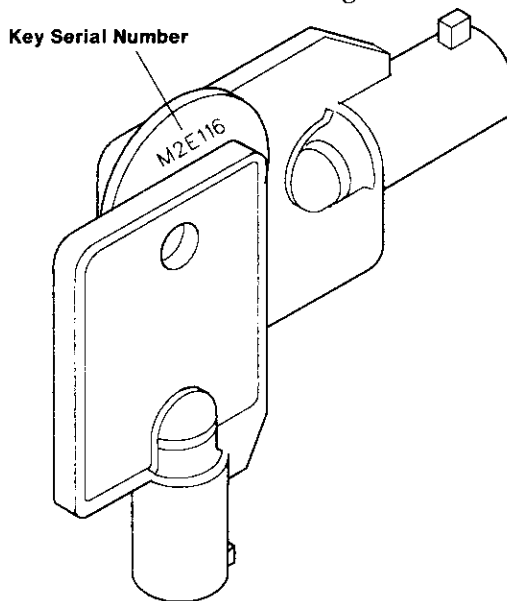

AS06A005

Remember, you are responsible for the security of the system.

Power On and Power Off

The power switch is used to turn the system on and off. After you turn the power switch on, the system performs an internal Power On Self Test (POST). The green power-on light is lit when the power is on.

Ensure that the power cord located at the back of the system unit is plugged in the system unit and also into the electrical wall outlet.

See your application documentation for information on the system login procedure.

Warning: When using the AIX Operating System, enter the **shutdown** command before you turn the power off. Failure to do so may result in the loss of data. If you turn the power off before shutting down the AIX Operating System or need information on the correct shutdown procedure, see *Using and Managing the AIX Operating System*.

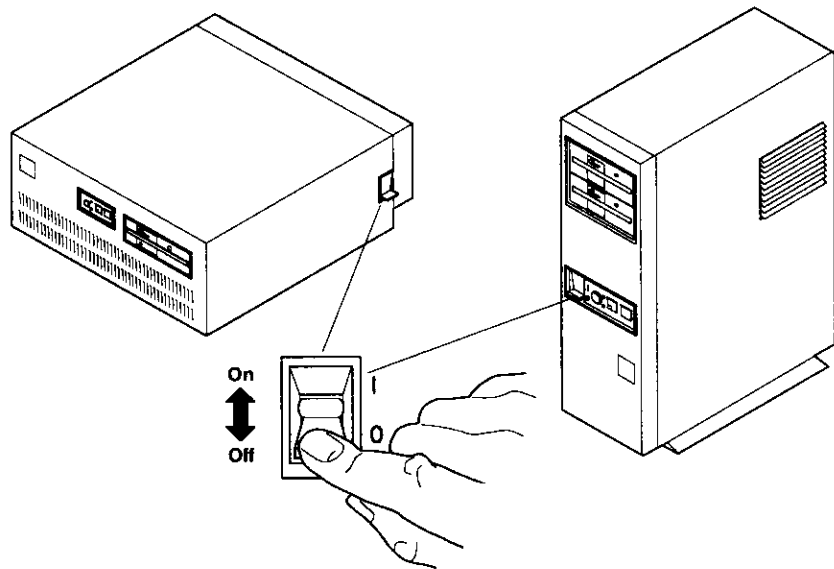

AS06A006

Two-Digit Display

The two-digit display on the operator panel of the system unit displays numbers that indicate the progress of the Power On Self Test (POST).

Several numbers appear on the two-digit display as the POST progresses. If an error is detected that requires your attention, the system unit stops and a number appears in the two-digit display that identifies the error. The two-digit display is blank when the POST completes with no errors detected.

See the *Problem Determination Guide* for an explanation of the displayed numbers and instructions to correct the problem.

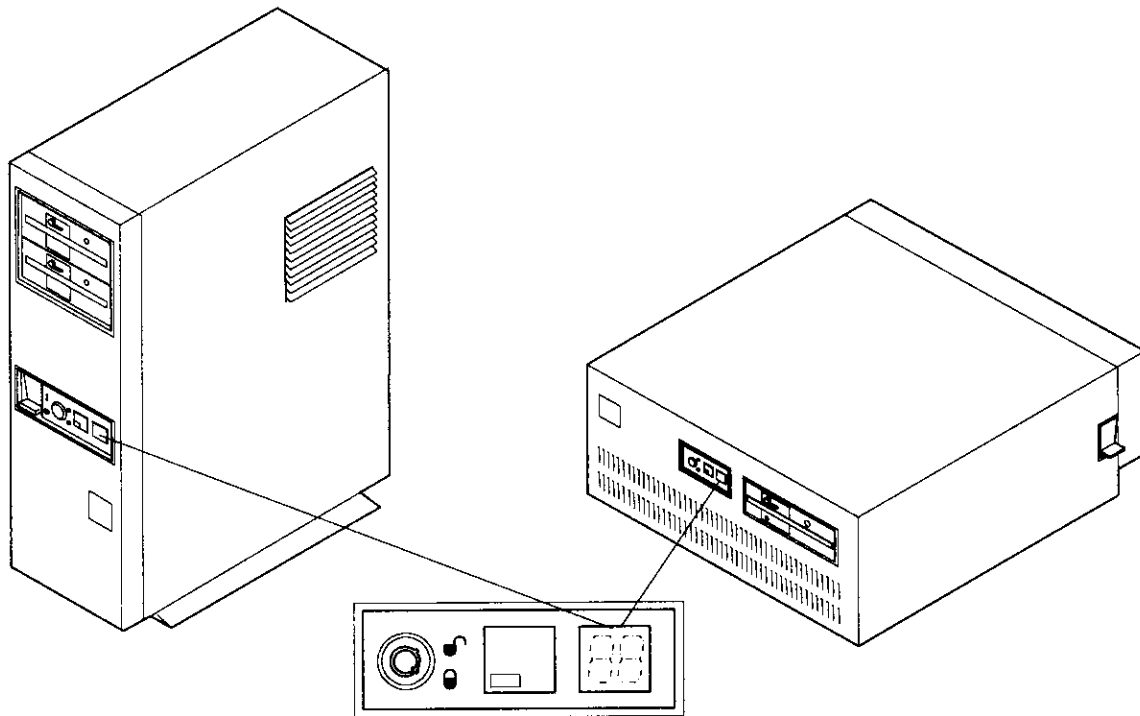

AS06A007

Diskettes

Diskettes store data as a series of magnetic fields on a disk enclosed in a protective plastic jacket. The plastic jacket protects the magnetic disk from dirt and damage. A storage envelope provides additional protection.

Warning: You must use the correct types of diskettes to assure the successful operation of the IBM RT PC System. If you use the incorrect diskette, the data on the diskette is destroyed. See “About Diskette and Drive Compatibility” on page 1-17 for additional information on selecting a diskette.

You should format diskettes to be used by the IBM RT PC System. The way your diskettes are formatted depends upon the program and the type of drive you are using. Refer to the documentation for your program and *Using and Managing the AIX Operating System* for information on formatting diskettes.

You can use diskettes, tapes, or fixed disks to store and back up files. For additional information see *Using and Managing the AIX Operating System* or *Usability Services Reference* (if Usability Services is installed on the system).

Write-Protect

When a diskette is write-protected, no information can be written on the diskette. To write-protect a diskette, cover the notch on the side of the diskette with a write-protect tab. Using write-protect tabs protects data on a diskette from being written on or erased. If you want to write information on a diskette, remove the write-protect tab. Some diskettes do not have a notch. These diskettes are already write-protected and information cannot be written on the diskette by the computer.

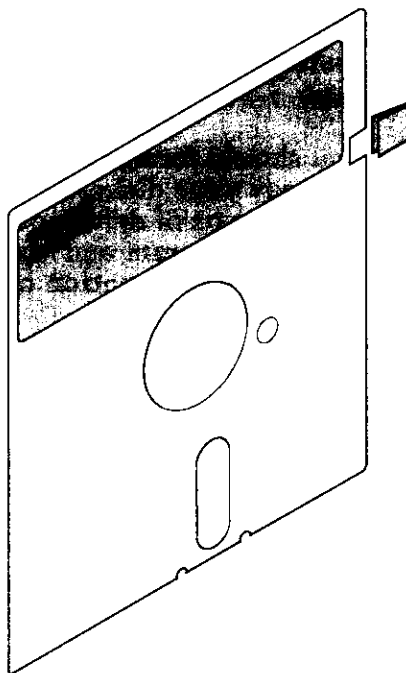

AS06A008

Diskette Care

The figures below show correct and incorrect ways of handling the diskettes. Correct handling greatly reduces the possibility of damaging the diskettes.

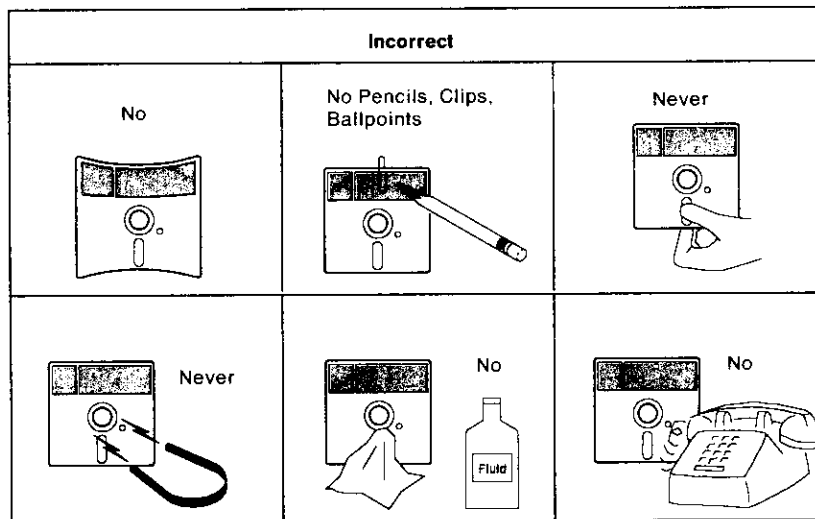
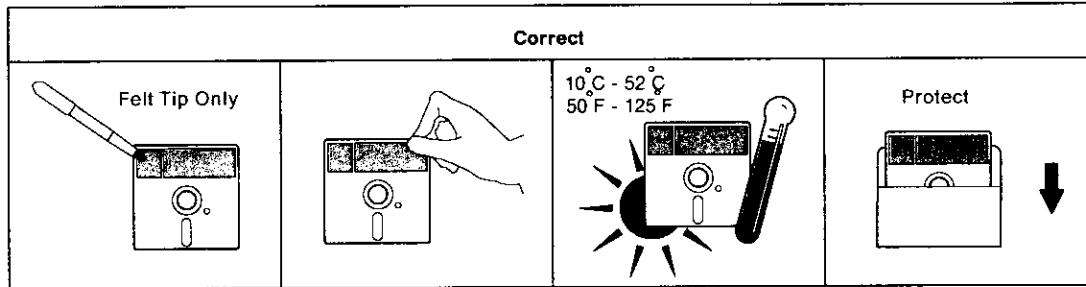

AS06A009

Diskette Drives

Diskette drives read and write data on diskettes. The Personal Computer AT High Capacity Diskette Drive in the IBM RT PC System stores approximately 1.2 M-bytes of data on a 5-1/4 inch diskette. The Personal Computer AT Dual-Sided Diskette Drive is an option for the IBM 6150. The Personal Computer AT Dual-Sided Diskette Drive stores up to 360 K-bytes of data on a 5-1/4 inch diskette and is identified by a large asterisk below the in-use light.

Program or data diskettes are inserted into diskette drives. Diskette drives enable the system to read or write data on diskettes.

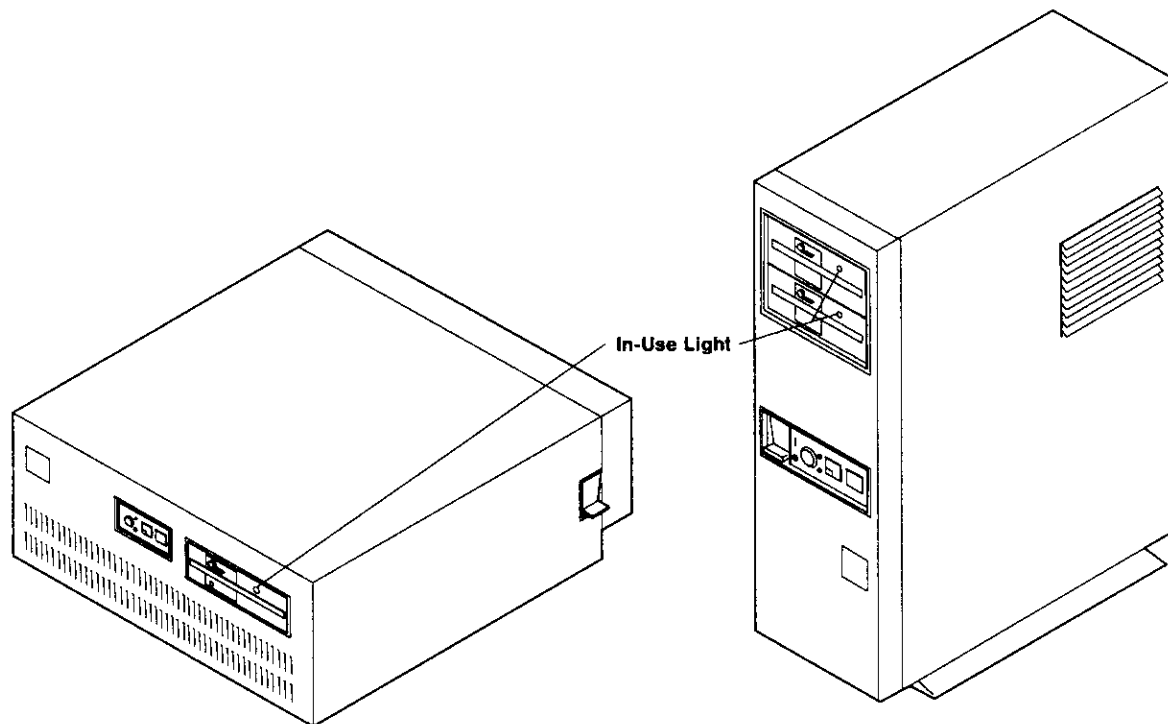

AS06A010

About Diskette and Drive Compatibility

The following chart shows the compatibility of the IBM RT PC System drives with different types of formatted diskettes.

Single-Sided Diskette (160/180K)	Dual-Sided Diskette (320/360K) 1	High-Capacity Diskette (1.2M) 2
Read or Write	Read or Write	Do Not Use 2
Read or Write 2	Read or Write 3	Read or Write

1 - The Personal Computer AT Dual-Sided Diskette Drive is an option for the IBM 6150 system unit.

2 - Do not use in a Personal Computer AT Dual-Sided Diskette Drive

3 - **Warning:** If you write on a single-sided or dual-sided diskette with the Personal Computer AT High Capacity Diskette Drive, reformat the diskette before using it in a Personal Computer AT Dual-Sided Diskette Drive. Save the data on your diskette before you reformat it. Reformatting the diskette causes the loss of data. The data written by a Personal Computer AT High Capacity Diskette Drive on a dual-sided diskette can only be read by a Personal Computer AT High Capacity Diskette Drive. To guard against accidental writing on these diskettes, you can place a write-protect tab on the diskette before you use it. Refer to "Write-Protect" on page 1-14.

Operating the Diskette Drive

The system has at least one diskette drive. If the system has two diskette drives installed, the first diskette drive is referred to as diskette drive position A and the second diskette drive is referred to as diskette drive position B. When you have two diskette drives, you can insert a diskette in diskette drive position A and a diskette in diskette drive position B.

To insert a diskette into the drive:

1. Remove the diskette from the storage envelope.

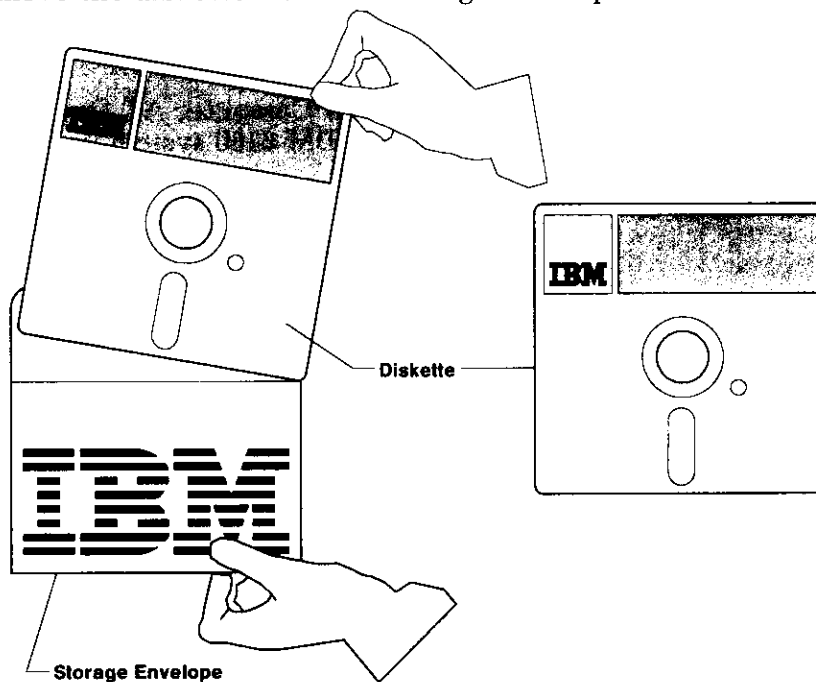

AS06A011

2. Rotate the drive lever on the diskette drive counterclockwise to the position shown below.

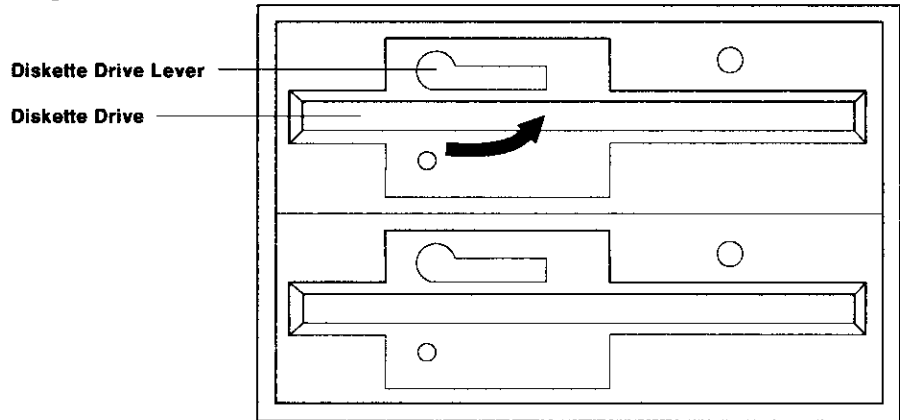

AS06A012

3. Insert the diskette into the diskette drive with the label facing up and the write-protect notch to the left.

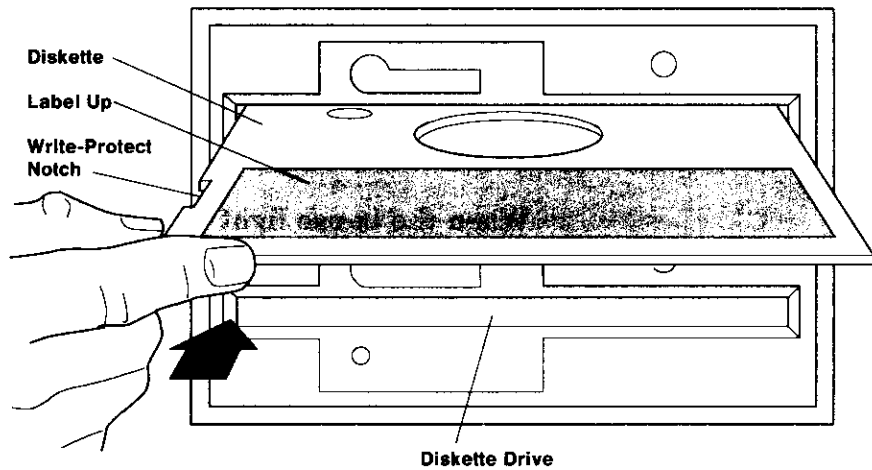

AS06A013

4. Close the diskette drive by rotating the drive lever clockwise.

Warning: Do not open the diskette drive or remove the diskette when the in-use light is on. Data on the diskette may be destroyed.

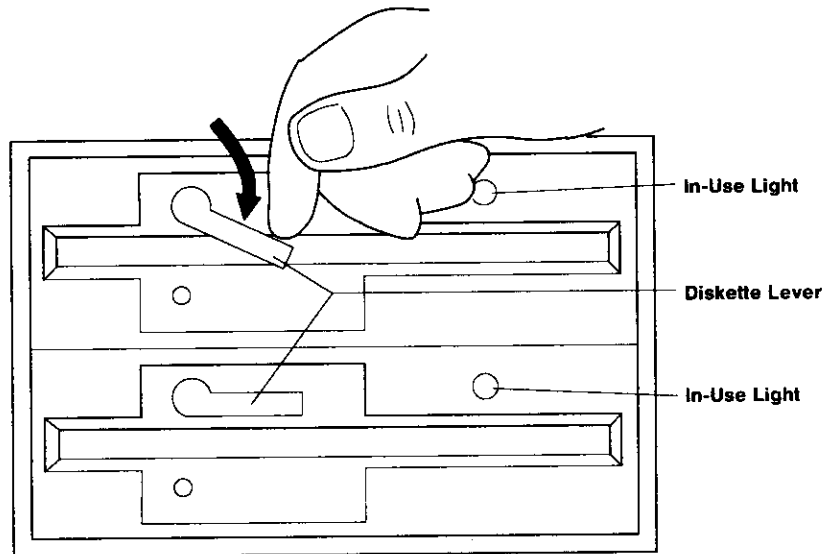

AS06A014

When the in-use light is on, it indicates that the system unit is using the diskette drive.

5. To remove the diskette from the diskette drive, rotate the diskette drive lever counterclockwise and pull the diskette out.
6. Insert the diskette into the storage envelope.

Fixed-Disk Drives

You can store and retrieve data using the fixed-disk drive with the AIX Operating System. A fixed-disk is sometimes called a hard file. It is called fixed because the disk is a permanent part of the system, rather than being inserted into a drive.

The IBM 6150 can have one, two, or three fixed-disk drives. The IBM 6151 has one fixed-disk drive. The IBM 6150 and 6151 use the same type of fixed-disk drives. The IBM 6156 Portable Disk Drive provides fixed-disks external to the system unit. The portable disk drive can be connected to either the IBM 6150 or 6151, when the required adapter is installed in the system unit.

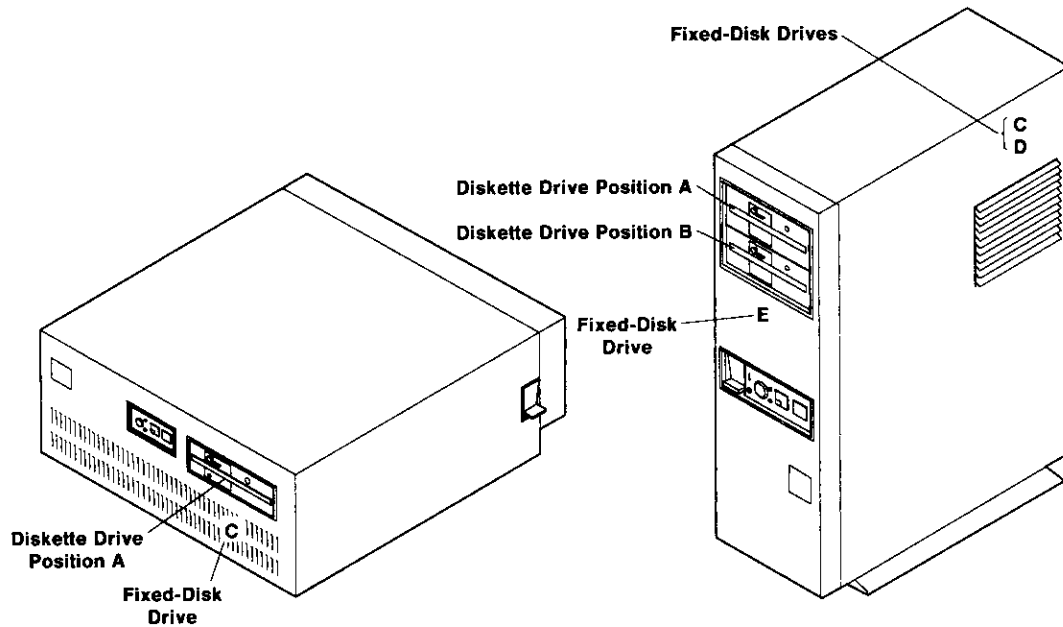

AS06A015

Data can become unusable because of a fixed-disk drive failure. You are responsible for the backup of the data stored on the fixed-disk. See *Using and Managing the AIX Operating System* for information on using diskettes or the IBM 6157 Streaming Tape Drive to back up files.

Section 2. Using the Keyboard and Mouse

CONTENTS

About This Section	2-3
Introducing the Keyboard and Mouse	2-4
Keyboard	2-5
Function Keys	2-6
Typewriter Key Area	2-7
Enter Key	2-8
Backspace Key	2-8
Spacebar Key	2-8
Shift Keys	2-9
Capitals (Caps) Lock Key	2-9
Control (Ctrl) Key	2-11
Alt Keys	2-11
Action Key	2-11
Spanish Characters	2-12
Cursor and Control Keys	2-13
Insert Key	2-15
Delete Key	2-15
Numeric Keypad	2-16
Num Lock Key	2-17
Enter Key	2-17
Line Drawing Characters	2-18
Multiple Key Commands	2-19
Reloading the AIX Operating System	2-19
IPLing the Coprocessor	2-20
Reloading the AIX Operating System and VRM	2-20
Reloading the AIX Operating System and VRM After Power-On Self Test (Simulated Hard IPL)	2-21
Keyboard Height Adjustment	2-22
Mouse	2-23
Mouse Care	2-24
Handling the Mouse Incorrectly	2-25
Mouse Preventive Maintenance	2-28
Mouse Cleaning	2-28

About This Section

Read this section to become familiar with how to operate the:

- IBM RT PC Keyboard
- IBM RT PC Mouse

This section describes the parts of the keyboard, how to use multiple key commands, and how to adjust the keyboard. Mouse care and handling are discussed.

Introducing the Keyboard and Mouse

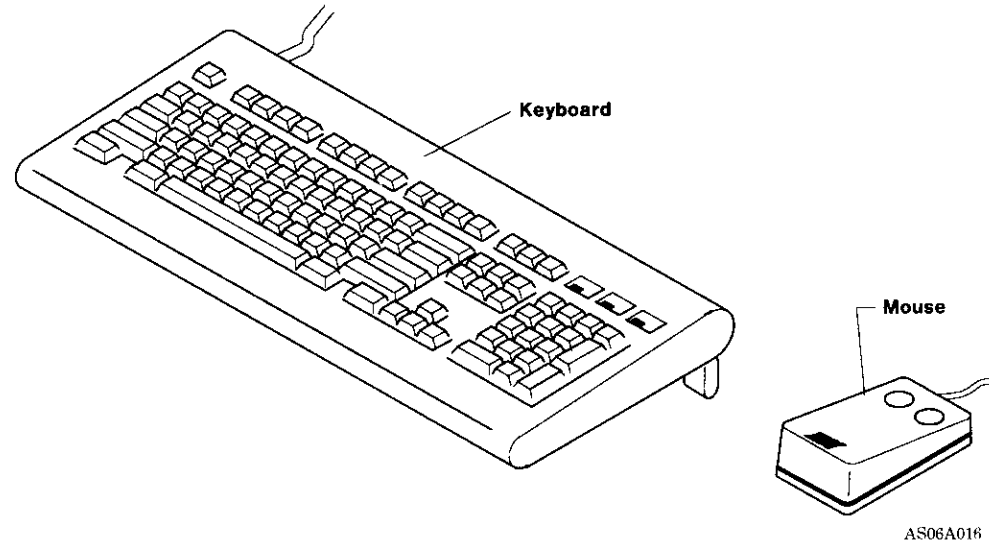

The IBM RT PC Keyboard consists of various keys that allow you to enter data, to control the cursor location, and to control the dialogue between you and the system.

The IBM RT PC Mouse is an optional feature used to control the cursor location.

Keyboard

The keyboard is divided into four sections: the function keys, the typewriter key area, the cursor and control key area, and the numeric keypad. The keyboard also has three status lights that show the status of the **Numeric (Num) Lock**, **Capital (Caps) Lock**, and the **Scroll Lock** keys. The **Escape (Esc)** key is defined by the application you are using.

The various programs you use on the AIX Operating System control most key functions. The following pages describe the four categories of keys. While some of the key functions are controlled by the application program, others have functions that remain constant, regardless of the application program being run. For other key functions and descriptions, you must refer to the user's guide for the particular program you are using.

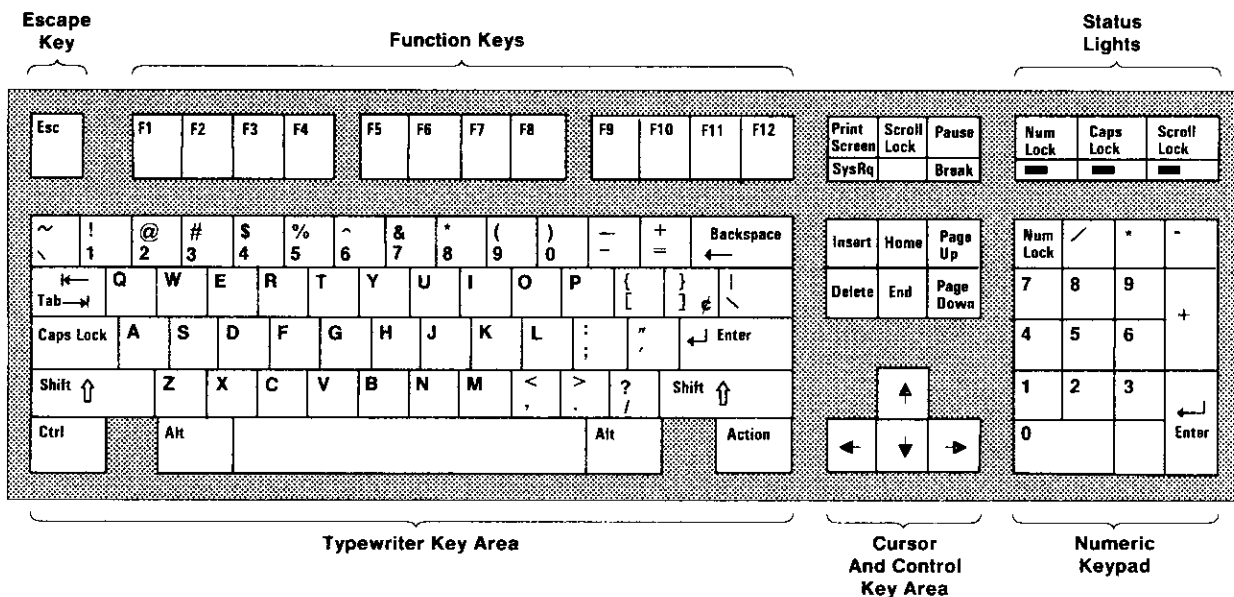

AS06A017

Function Keys

The twelve function keys are multipurpose keys and are always under program control. Their functions are defined in the user's guide for each application.

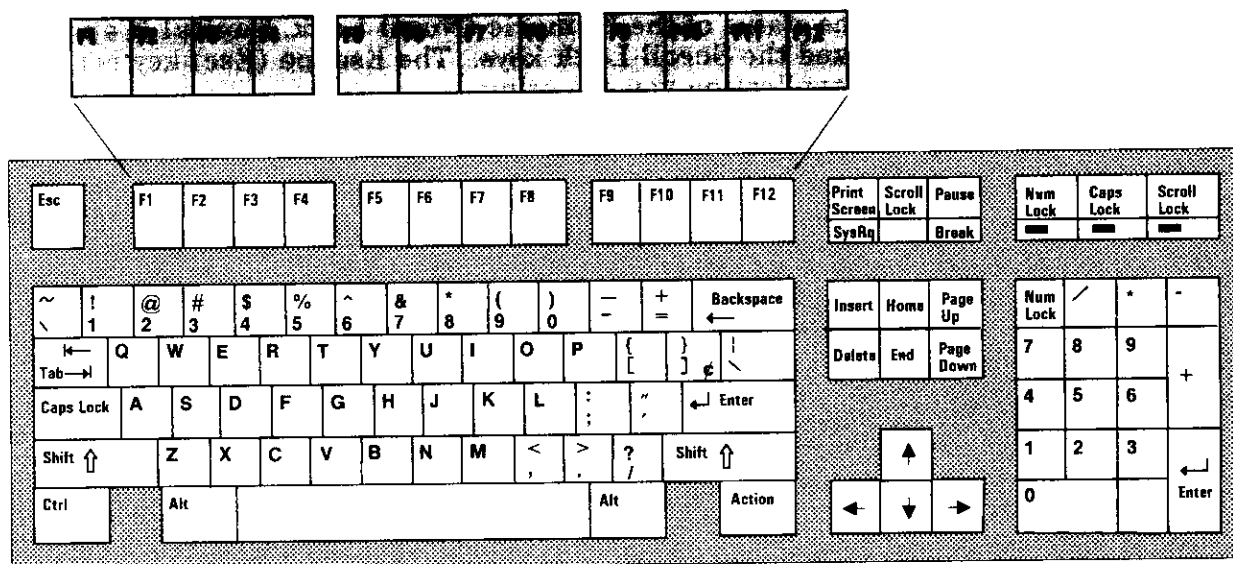

AS06A018

Typewriter Key Area

The keys in the typewriter key area are similar to those on a standard typewriter.

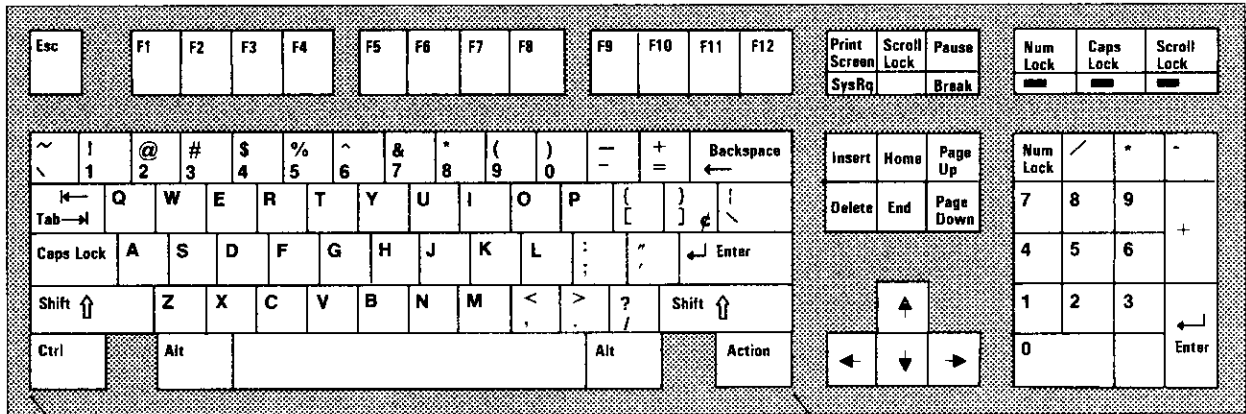

AS06A019

Enter Key

The use of the ← **Enter** key is defined by the application you are using.

Backspace Key

The ← **Backspace** key erases characters. Each time you press the **Backspace** key, it moves the cursor one position to the left and erases the character in that position.

Spacebar Key

The **Spacebar** key, when pressed, places a blank character on the display screen and advances one space.

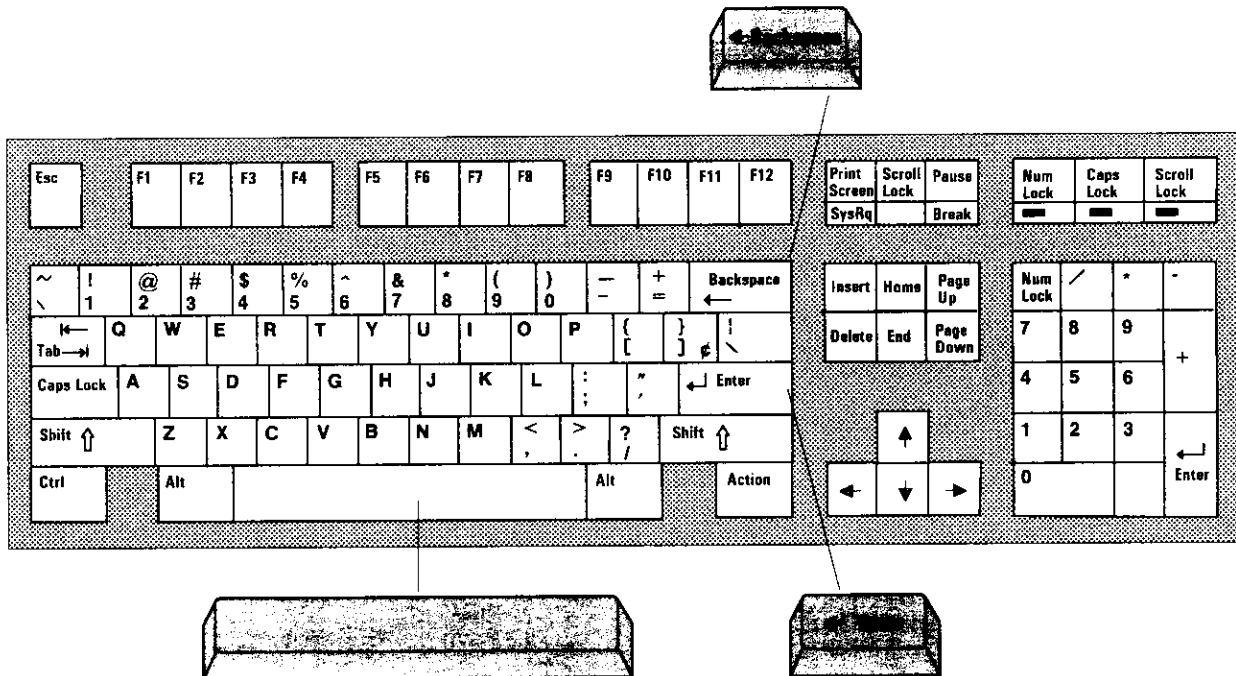

AS06A020

Shift Keys

There are two **Shift** keys on the keyboard. Pressing either of the **Shift** keys switches the letter keys from lowercase to uppercase and the numeric keys in the typewriter key area from numbers to symbols. Pressing the **Shift** key switches the numeric and period keys in the numeric keypad from line drawing characters to numbers and a period. The **Shift** key temporarily reverses the state of the capitals lock mode and the numeric lock mode. Pressing the **Shift** key in capitals lock mode switches the letter keys from uppercase to lowercase. Pressing the **Shift** key in numeric lock mode switches the numeric and period keys in the numeric keypad to line drawing characters.

Capitals (Caps) Lock Key

The Capitals (Caps) Lock light comes on when you press the **Caps Lock** key and the keyboard is now in capitals lock mode. The light lets you know that the A through Z keys are locked in uppercase. The light goes off when you press the **Caps Lock** key again, and your program is no longer in capitals lock mode. The capitals lock mode cannot be used to type the symbols that appear on the tops of other keys. Pressing either of the **Shift** keys temporarily switches the letter keys from uppercase to lowercase when you are in capitals lock mode.

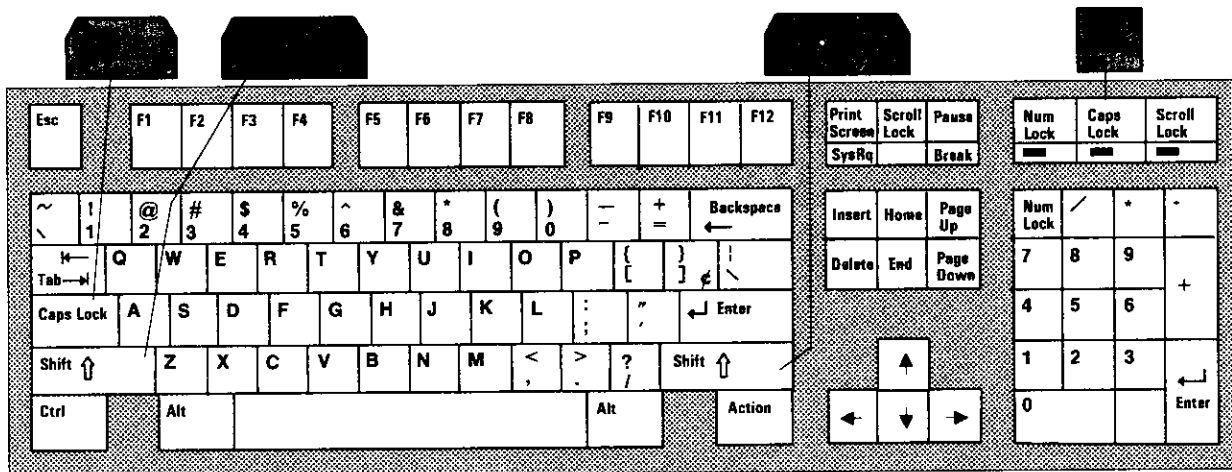

AS06A021

Control (Ctrl) Key

The **Control (Ctrl)** key is always used with another key to perform a command or function. Press and hold the **Ctrl** key, then press the selected key. The operation performed for a given control combination is determined by the application program being run.

Alt Keys

There are two **Alt** keys on the keyboard. The **Alt** keys are used to perform the function engraved on the front face of the keys. Press and hold one of the **Alt** keys. Then press the selected key with the front face engraving. An example of a key with a front face engraving is shown below. The **Alt** keys are also used, like the **Ctrl** key, in multiple key sequences to perform control functions.

Action Key

The **Action** key is used to inform application programs that you are ready to have data (on the screen) processed. The operation performed is determined by the application program you are using.

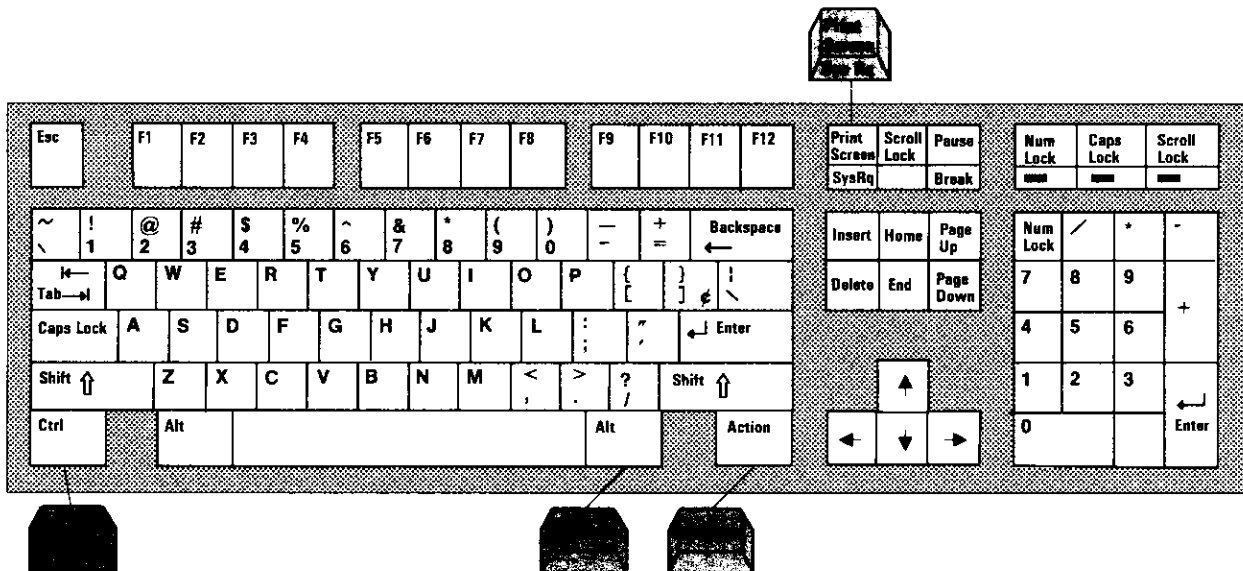

AS06A022

Note: When entering data into your computer, the zero (0) key and the letter (O) key are not interchangeable. The number one (1) key and the lowercase letter (L) key are also not interchangeable.

Spanish Characters

Spanish characters accented in the Spanish language are located on some of the alphabetic keys. These characters are not engraved on the keyboard. You can use the Spanish punctuation keys by pressing the **Alt** key and then the selected key. The following keys illustrate which Spanish punctuation characters are located on the typewriter key area.

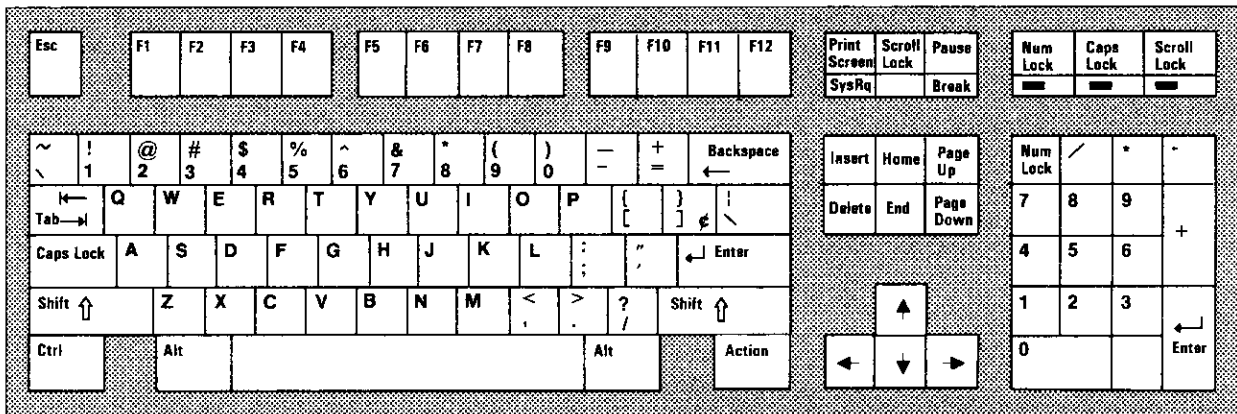

AS06A023

Cursor and Control Keys

The cursor is the blinking text marker that shows where you are on the screen. The Cursor control keys allow you to move the cursor around on the screen. The following cursor control key functions describe how the cursor is moved when you are working in text.

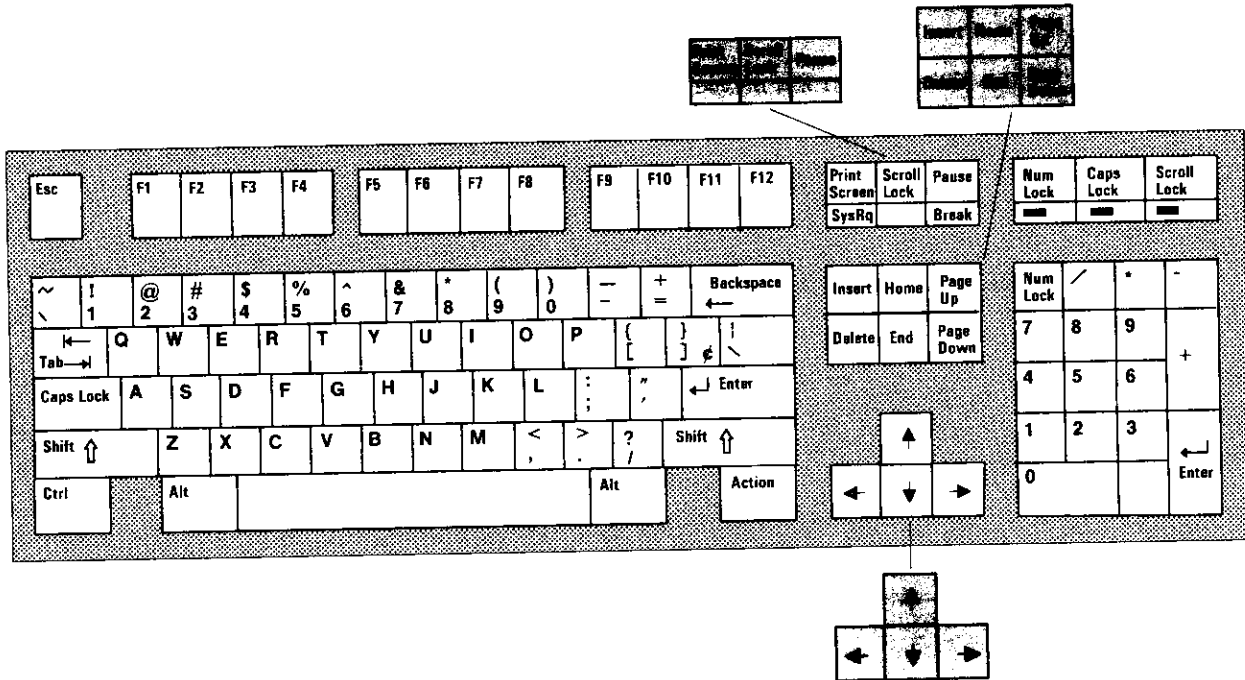

AS06A024

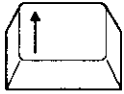

The **Cursor Up** key moves the cursor one line up.

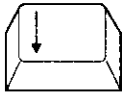

The **Cursor Down** key moves the cursor one line down.

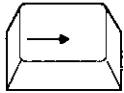

The **Cursor Right** key moves the cursor one character position to the right.

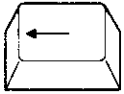

The **Cursor Left** key moves the cursor one character position to the left.

AS06A025

Insert Key

The **Insert** key is used to insert data in a line and its use is controlled by the application program you are using. When a character is inserted, all data to the right of the cursor moves right one position. Press the **Insert** key once and the cursor changes shape to indicate the insert mode. Press the **Insert** key again and the application program is no longer in insert mode.

Delete Key

The **Delete** key erases the character where the cursor is positioned. When a character is deleted, all data to the right of the cursor moves left one position.

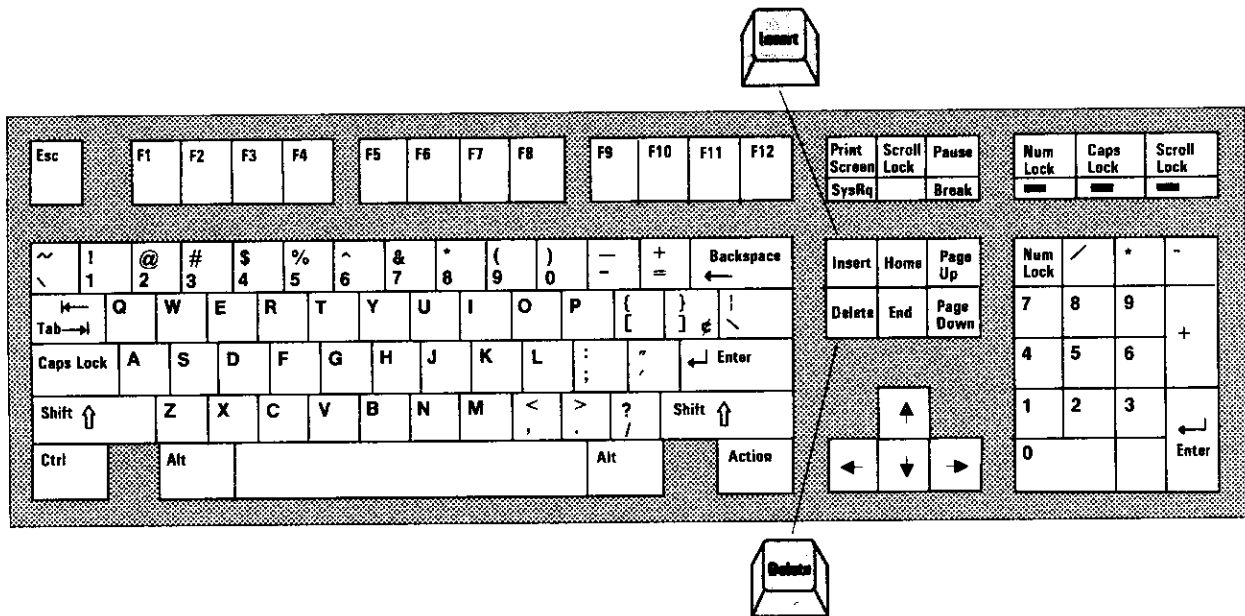

AS06A026

Note: The use of the **Scroll Lock**, **Pause**, **Home**, **Page Up**, **End**, and **Page Down** keys is defined by the application you are using.

Numeric Keypad

The numeric keypad is arranged like a calculator to save time when typing many numbers. When the system is powered on, keys 0 through 9 are in graphics mode and the numeric lock light is off.

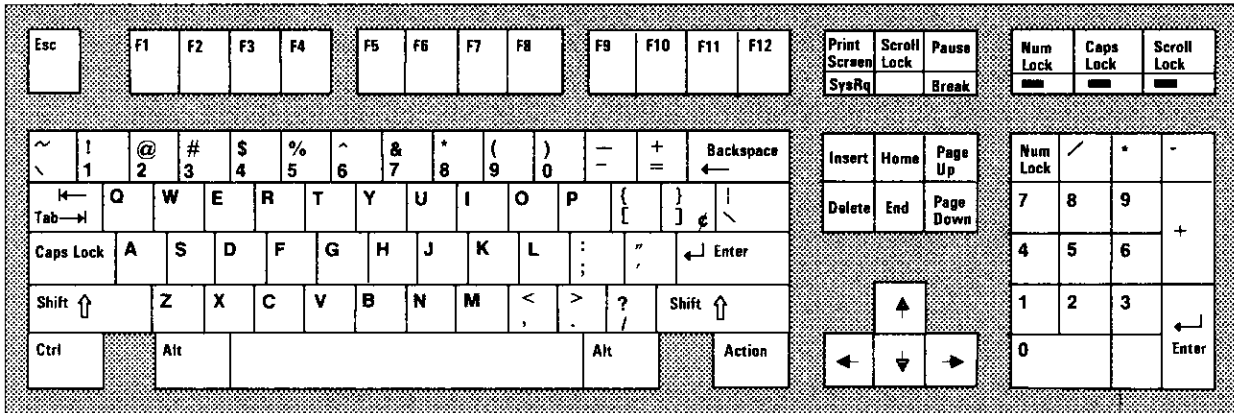

AS06A027

Num Lock Key

When you press the **Num Lock** key, numeric lock mode and the numeric lock light are turned off if they were already on, or are turned on if they were previously off.

Enter Key

The use of the ← **Enter** key is defined by the application you are using.

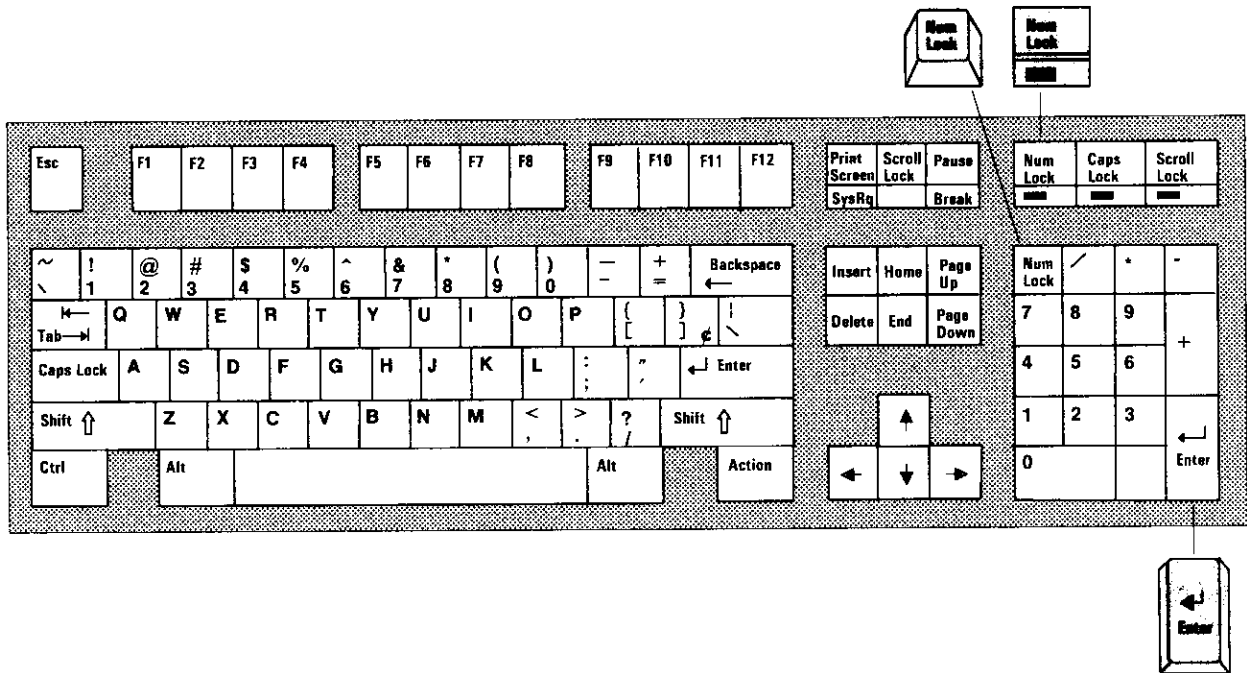

AS06A028

Line Drawing Characters

Line drawing characters are located on the numeric and period keys. You can use the characters to draw boxes for graphic charts or drawings. These characters are not engraved on the numeric keypad. You can use these characters while the numeric keypad is in an unshifted state. The keyboard is in an unshifted state when the numeric lock mode is off and the **Shift** key is not being held down. The following illustration shows which unengraved characters are located on the numeric and period keys for line drawing.

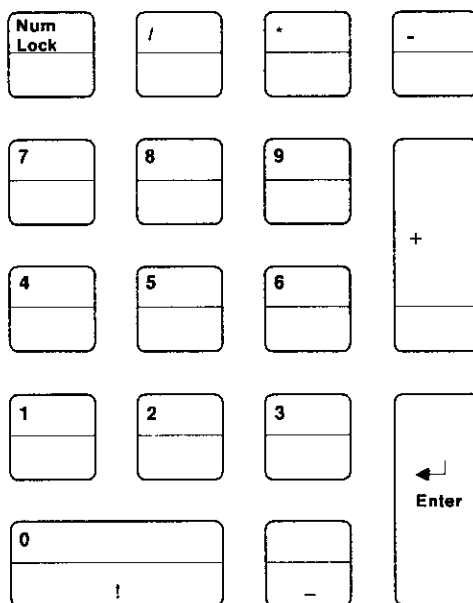

AS06A029

Multiple Key Commands

The following commands are examples of multiple key AIX Operating System sequences that perform control functions. You can use these commands when the AIX Operating System is not operating correctly and all efforts at recovery have failed.

Reloading the AIX Operating System

Warning: The following control function will delete the data and programs in memory. Shut down the AIX Operating System before you perform this control function. If the AIX Operating System cannot be shut down, a file system recovery operation may be required.

Press and hold the **Ctrl** and the left **Alt** keys. Then, press the **Home** key to IPL the system and reload the AIX Operating System. The operation of the Virtual Resource Manager (VRM) is not affected.

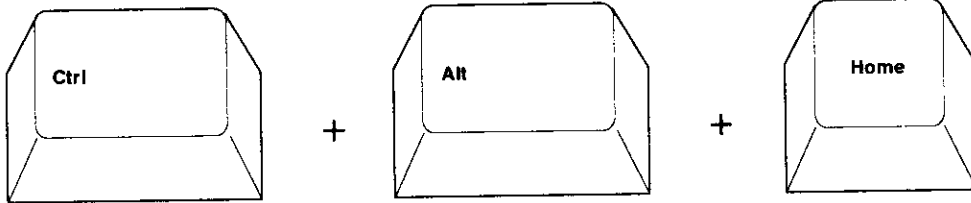

AS06A039

IPLing the Coprocessor

Press and hold the **Ctrl** and the left **Alt** keys. Then, press the **Delete** key to IPL the coprocessor.

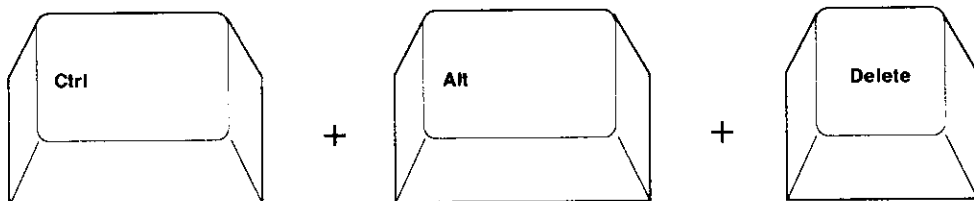

AS06A031

Reloading the AIX Operating System and VRM

Warning: The following control function will delete the data and programs in memory. Shut down the AIX Operating System before you perform this function. If the AIX Operating System cannot be shut down, a file system recovery operation may be required.

Press and hold the **Ctrl** and the left **Alt** keys. Then, press the **Pause** key to generate a system IPL that reloads the AIX Operating System and VRM.

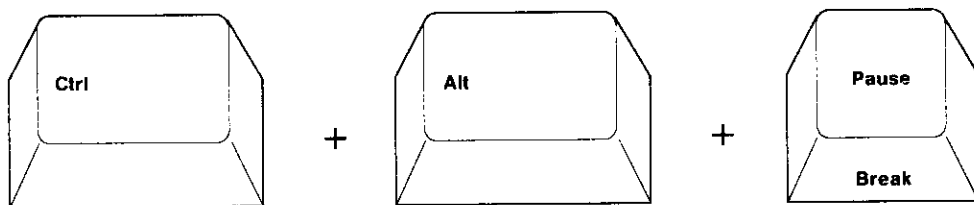

AS06A032

Reloading the AIX Operating System and VRM After Power-On Self Test (Simulated Hard IPL)

Warning: The following control function will delete the data and programs in memory. Shut down the AIX Operating System before you perform this function. If the AIX Operating System cannot be shut down, a file system recovery operation may be required.

Press and hold the **Ctrl** and the **Alt** keys. Then, press the **numpad 6** key to generate a system IPL that reloads the AIX Operating System and VRM.

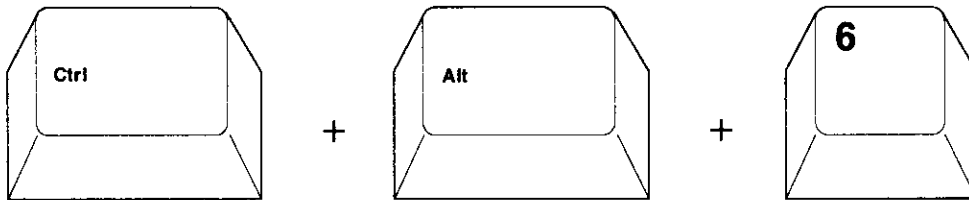

AS06A033

Keyboard Height Adjustment

You can adjust the keyboard to the tilt or level position for typing comfort.

To slope or tilt the keyboard, pull out on the keyboard legs.

To decrease the slope of the keyboard, push in on the back of the keyboard legs until they snap into the bottom of the keyboard case.

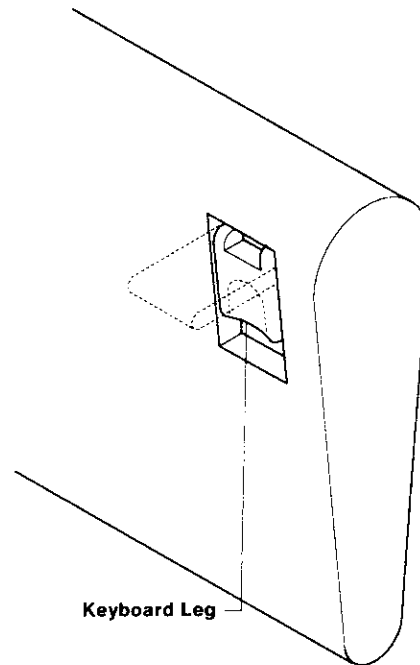

AS06A034

Mouse

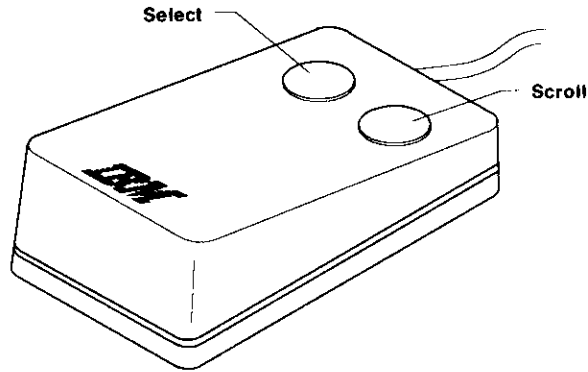

AS06A035

The mouse is a hand-operated locator device. You can use the mouse to position the cursor, select items from a menu, and to enter data for graphic applications. The mouse operates on any flat surface, such as a desk top.

Moving the mouse around a flat surface moves the cursor on the display screen. This movement positions the cursor.

With the two buttons located on top of the mouse, you can select options and scroll the contents of the screen. Use the select button located on the left, to select a particular item on the screen. Use the scroll button located on the right, to scroll the contents of the screen.

Mouse Care

The operating surface for the mouse should be smooth, clean, and flat. For example, you can operate the mouse on the following surfaces:

- Finished wood
- Glass
- Enamel
- Plastic
- Paper
- Metal
- Formica.

Rough surfaces collect contaminants that can be transferred to the interior of the mouse by the roller ball. The surface you use should be free of spills, dirt, dust, lint, wax, eraser dust, and other foreign matter. Rough surfaces can also cause the felt pads located on the bottom of the mouse to prematurely wear. A deeply pitted surface could cause erratic operation of the mouse.

Handling the Mouse Incorrectly

You can damage the mouse if you handle it incorrectly. The following examples describe incorrect mouse handling.

- Don't operate the mouse on cloth, unfinished wood, newspaper, or carpet.

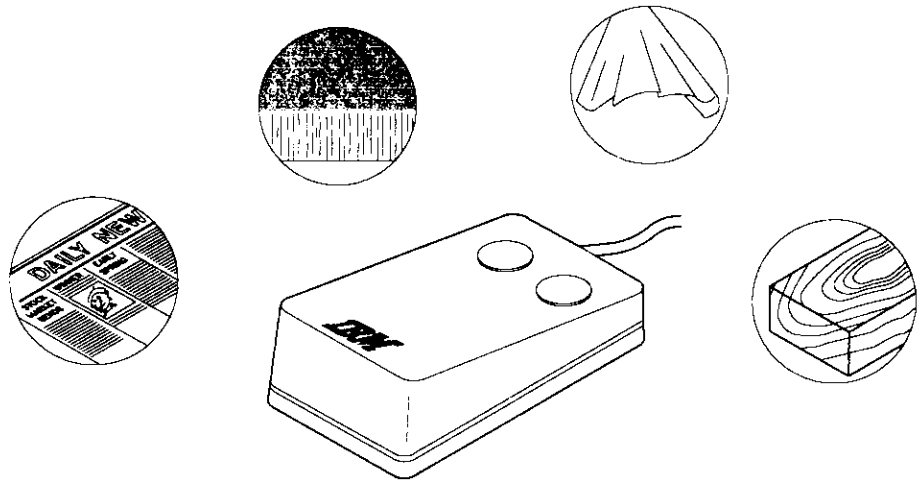

AS06A036

- Don't drop or hit the mouse.

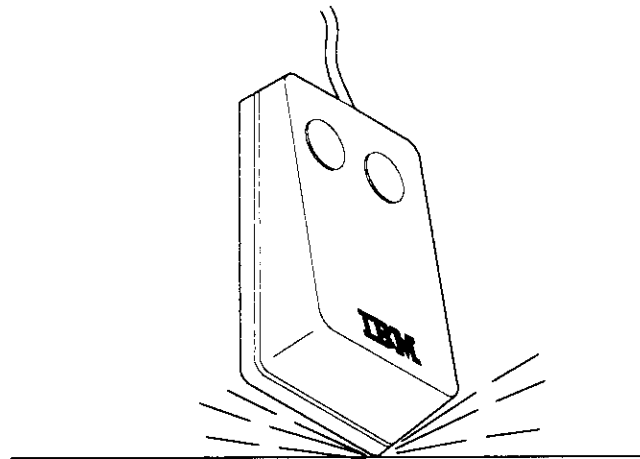

AS06A037

-
- Don't pull the cable. You may cause damage to the cable and the connector.

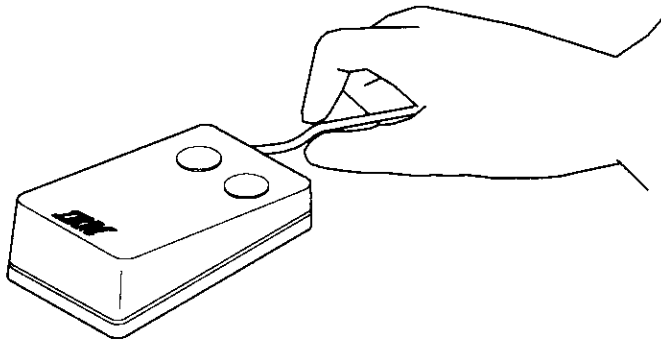

AS06A038

- Don't carry the mouse by holding onto the cable.

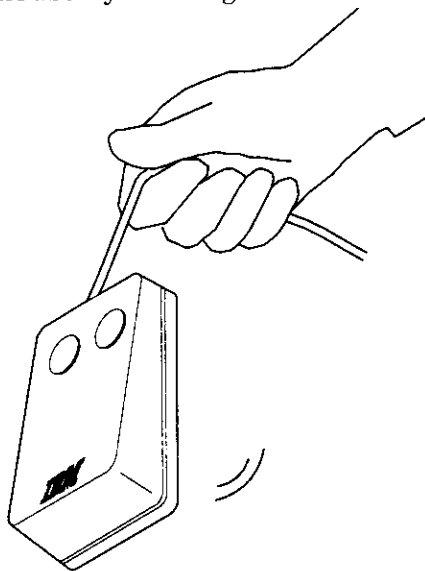

AS06A039

-
- Don't expose the mouse to extreme temperatures or direct sunlight.

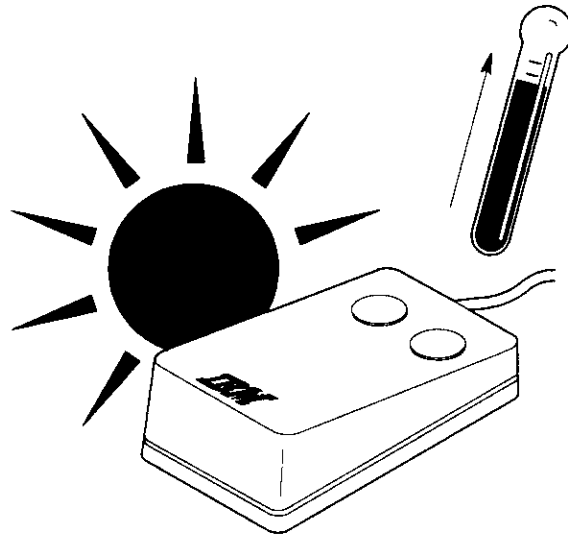

AS06A040

- Don't place the mouse in liquid spills.

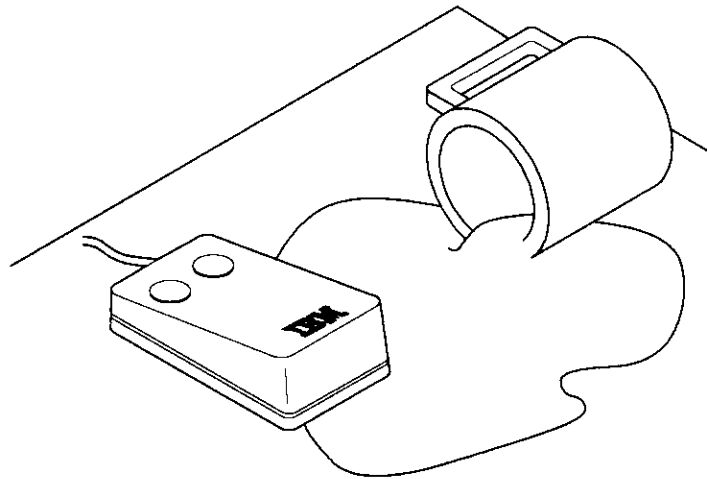

AS06A041

Mouse Preventive Maintenance

Inspecting your work surface helps to prevent the transfer of contaminants to the interior of the mouse by the roller ball.

1. Inspect the work surface for spills or other contaminants.
2. Dust the work surface.
3. If you are using a paper pad, inspect it for wear and replace it if necessary.

Mouse Cleaning

The following steps describe how to clean the mouse.

1. Remove the snap-out cover by pushing the **open** arrow.

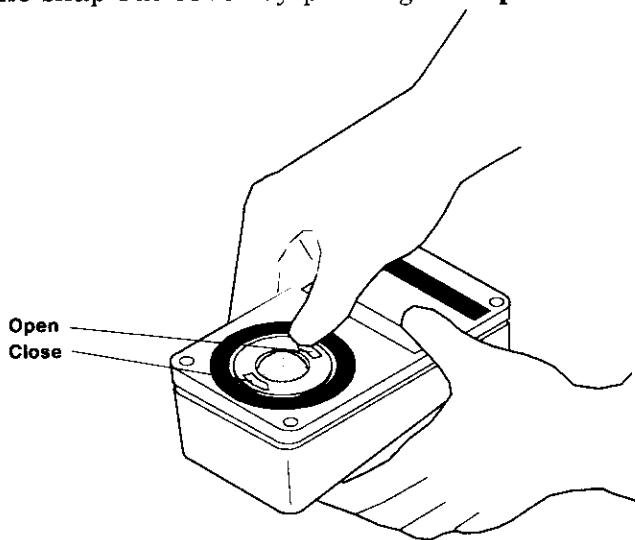

AS06A042

-
2. Remove the roller ball.

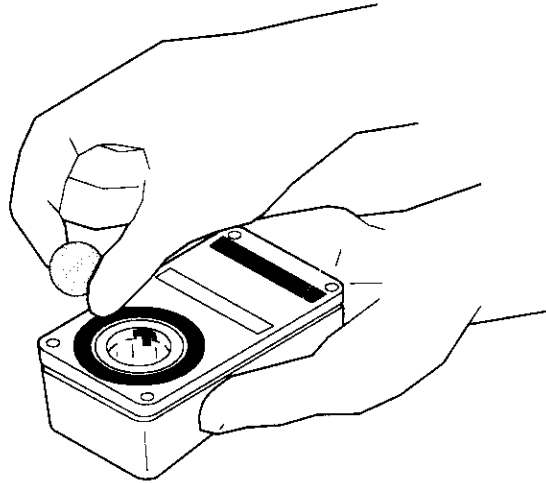

AS06A043

3. Inspect the roller ball for contaminants. Wipe it clean with a dry, lint-free cloth.
4. If the roller ball is dirty, wash it in warm, soapy water. Rinse and wipe the roller ball with a lint-free cloth until dry.
5. Inspect the roller ball cavity in the mouse for foreign materials. If there are any foreign materials, remove them.

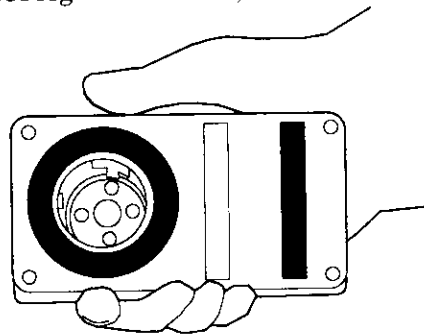

AS06A044

-
6. Replace the roller ball.

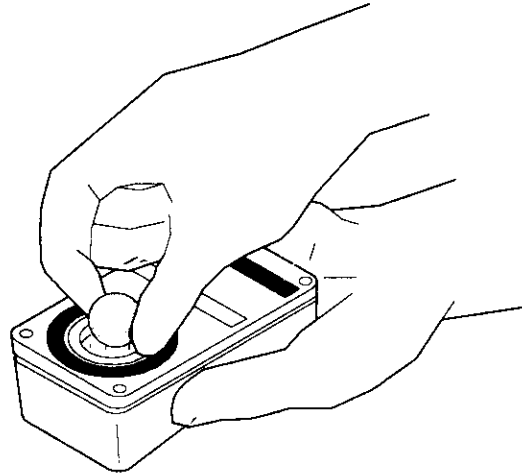

AS06A045

7. Replace the cover on the mouse with the **open** arrow aligned with the slot in the roller ball cavity.

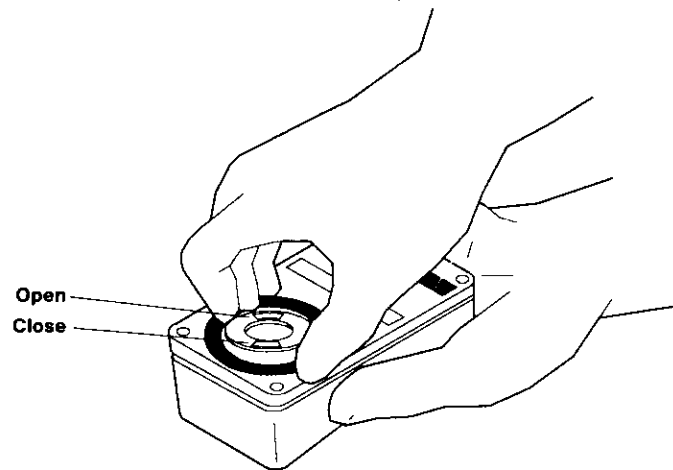

AS06A046

8. Close the cover by pushing the **close** arrow.