

The IBM logo, consisting of the letters "IBM" in a bold, sans-serif font, is positioned inside a dark rectangular box.

Systems Reference Library

IBM 2741 Communication Terminal

This publication describes the application areas, principles of operation, line-control signals, and special features of the IBM 2741 Communication Terminal. The communications facilities and data sets that can be used with this teleprocessing terminal are discussed. Also included are a glossary of communications terms used in this publication, timing considerations, code charts, and keyboard arrangements.

Fourth Edition (August 1972)

This is a reprint of the Third Edition, incorporating changes released in Technical Newsletter GN27-3053 (dated February 3, 1970).

Changes are periodically made to the information herein; before using this publication in connection with the operation of IBM systems or equipment, refer to the latest Technical Newsletter that is applicable and current.

Requests for copies of IBM publications should be made to your IBM representative or to the IBM branch office serving your locality.

This manual has been prepared by the IBM Systems Development Division, Publications Center, Department E01, P.O. Box 12275, Research Triangle Park, North Carolina 27709. A form for readers' comments is provided at the back of this publication. If the form has been removed, comments may be sent to the above address. Comments become the property of IBM.

CONTENTS

IBM 2741 COMMUNICATIONS TERMINAL	5	SPECIAL FEATURES	13
Communications Terminal Concepts	5	Typamatic Keys	13
APPLICATIONS	7	Receive Interrupt	13
On-Line Scientific Computation	7	Transmit Interrupt	13
On-Line Computer Programming	7	Print Inhibit	13
Text Handling	7	Dial Up	13
IBM 2741 COMMUNICATIONS TERMINAL DESCRIPTION	9	Pin-Feed Platens	13
IBM 2741 Keyboard	9	COMMUNICATIONS CONSIDERATIONS	14
IBM 2741 PRINCIPLES OF OPERATION	11	IBM Line Adapter (Limited Distance Type 1)	14
General Operation	11	IBM Line Adapter (Limited Distance Type 2)	14
Modes of Operation	11	IBM Line Adapter (Leased Line)	14
IBM 2741 Line Control	11	IBM Line Adapter (Shared Line)	14
Programming Considerations	11	CODE CHARTS AND KEYBOARD ARRANGEMENTS	15
Keyboard Considerations	12	GLOSSARY OF TERMS	21
Timing Considerations	12		

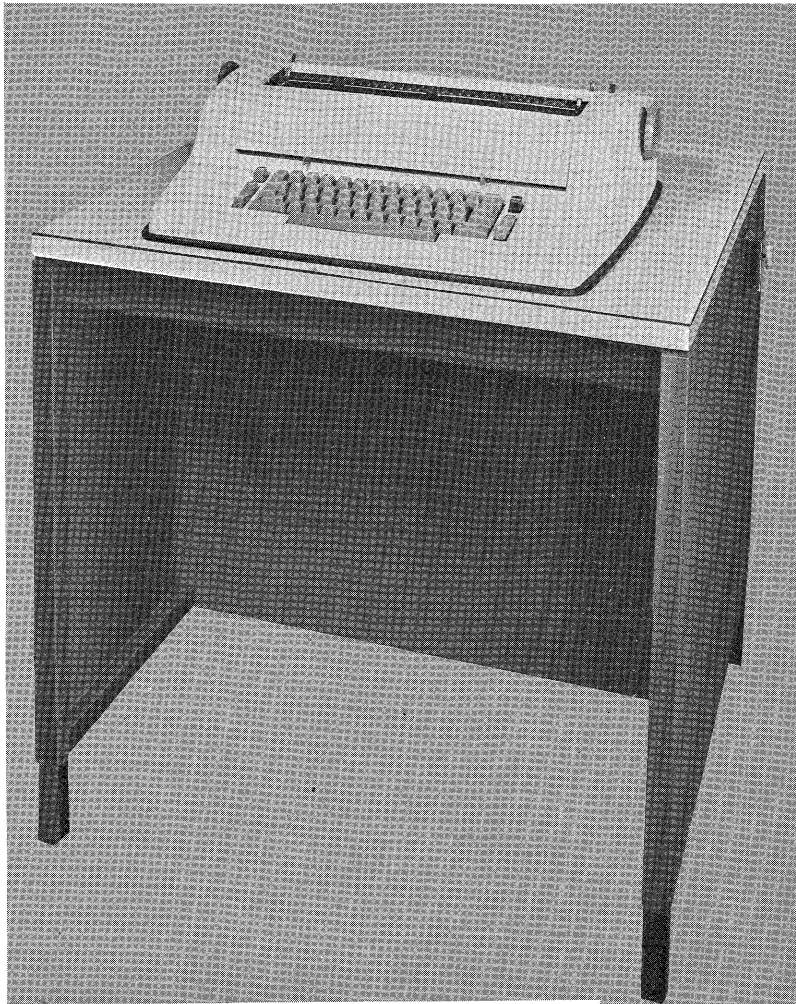

Figure 1. IBM 2741 Communications Terminal

IBM 2741 COMMUNICATIONS TERMINAL

The IBM 2741 Communications Terminal is a remote input/output terminal providing direct access to a computer such as an IBM System/360 through a multiplexor such as an IBM 2701 Data Adapter Unit, 2702 or 2703 Transmission Control Unit, or an IBM 2712 Remote Multiplexor connected to a 2702 or 2703. Hereafter these units will be referred to as multiplexors for ease of reading. The terminal (Figure 1) is an IBM Selectric® typewriter with the electronic controls necessary to enable it to communicate with the System/360. It is designed to operate as a remote conversational terminal, entirely dependent on specific computer programs. This dependency makes computer control of all program procedures possible, thereby relieving the terminal operator of these details. Each 2741 is connected to the System/360 through a multiplexor by either a privately owned or a common-carrier provided communications line. Only one 2741 is connected to a line, thus providing direct and immediate access to the computer. The 2741 is ideally suited for text handling, on-line computation, and programming applications. Its use can be expanded, however, to include any application area requiring a conversational mode of operation, limited only by the bounds of the programmer's creativity and ingenuity. With the IBM 2741, the power and versatility of the modern data processing system is available to the user of a simple, low-cost typewriter terminal.

One IBM System/360 and multiplexor can service many IBM 2741 Communications Terminals (Figure 2). The maximum number of terminals depends on either the communication facilities or the capacity and equipment of the computer. The optimum number of terminals is determined by the specific application.

Communications Terminal Concepts

The potential of the electronic data processing machine is constantly being explored. The early use of the computer in accounting applications involved one given set of information (punched in cards). A fixed series of operations was performed upon each set of data (record). If a file of cards was to be updated, the changes were also punched into cards and collated into the master file before the processing began. Then, a new file was punched by the computer. With the use of magnetic tape, three tapes were used to streamline this typical operation. The old file, the changes, and the new file were separate. Even with numerous improvements in machines and

techniques, the concept of one-operation-at-a-time remains basic to most applications.

At present, the central processing unit (CPU) does, in fact, do one operation at a time. (This is an oversimplification, since separate operations may be carried on by an input or output unit, a channel, or a directly connected CPU; or these operations may be overlapped.) However, these one-at-a-time operations take place at a very high speed measured in microseconds and nanoseconds. The rapidly developing field of multiple programming is one aspect of this advance. Why wait for a card to be read? It takes about a tenth of a second. Switch to another job and work on it until the information from the card has been delivered.

Another concept applicable to usual uses of the computer is that of minimizing the requirement for human intervention. Since the machines are very fast, they need not wait for people to sense a signal, think, and react, since this will result in a time delay.

The IBM 2741 Communications Terminal is a step into a new application area where these concepts no longer apply. The computer handles many different jobs concurrently and each step of each job is under the control of an operator.

When handling text, the computer does not calculate or analyze the "data" or text entered into it. The information coming in from many terminals is simply stored in order, with the codes defining sentences, paragraphs, charts, and space for figures. If there is an insertion or a deletion, the computer stores these. Precisely because people require a

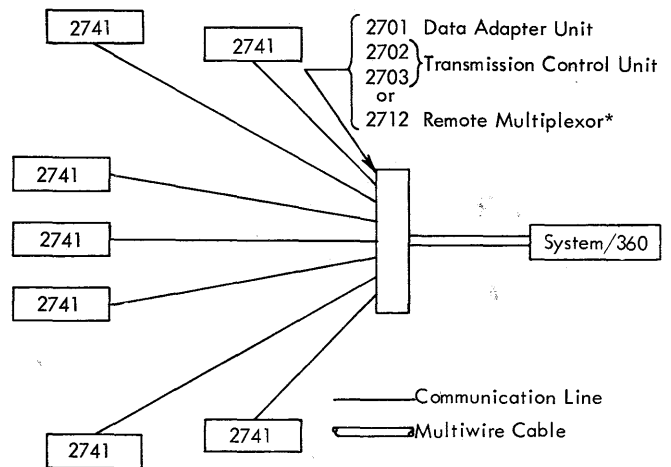

*If a 2712 Remote Multiplexor is used, it must connect to a 2702 or 2703 Transmission Control Unit which in turn connects to the System/360.

Figure 2. System Configuration

relatively long time to perform operations, the computer is able to switch electronically from terminal to terminal and keep incoming and outgoing data in order.

A request to retrieve the stored text includes format instructions. Then the computer operates upon the data. It divides the text up into lines of specified length. If right margins are to be justified, spaces are inserted between words in a specific pattern to accomplish this. Between servicing the other terminals and executing similar operations, the computer sends the text to the proper terminal at the maximum rate of the terminal.

The text-handling capability of a multiterminal computer is only one aspect of this relatively new concept: time-sharing. Many people, each at his own terminal, can be using the computer concurrently. This utilizes efficiently the capabilities of the computer. Time-sharing is applicable to such areas as engineering, programming, education, and design, as well as text handling.

Without time-sharing, data is processed by performing one (or a few) identical operations repeatedly on similar records of data. However, the speed and versatility of the computer are advantageous in many other fields. When the processing of smaller, more specialized jobs is limited to purely scientific installations, utilization is not high. Now, with

time-sharing, a number of terminals are connected to the computer, each holding control of the computer intermittently; specialized jobs are efficiently handled. The program used to accomplish this would include a phase (routines) to keep track of the communications and whatever working phases are desired. These working phases might include a modified Fortran compiler for computation, an assembler for programming, or a library and modified input/output control phase for information retrieval.

Basic to time-sharing and text handling is the idea of "man-machine conversation." An individual enters some information into the computer. The computer processes the information. This action may be formatting, computation, a search for and retrieval of additional data, or a combination of these. The result is returned to the person. In the case of text handling, the result is accumulated in the computer and may be modified. With time-sharing, the computation might, for example, include the loading of a routine to solve a differential equation and the solution of that equation with a given set of parameters. Typically, the computer relieves the operator of most of the time-consuming, repetitious details associated with creative work. The output of the operator can be expected to rise in quality as well as quantity.

The IBM 2741 is designed to require minimum operator training. The terminal, considered by itself, is a typewriter capable of maintaining line control, encoding the characters typed, and presenting the signal to a communication channel. (See Communications Considerations and IBM 2741 Line Control sections). Therefore, the applications of this terminal are determined by the program used by the computer. Scientific computation, computer programming, document preparation, and information retrieval are some areas of time-sharing application.

On-Line Scientific Computation

Many approaches are possible in the area of computation. The entire problem may be defined by the operator in a symbolic language such as Fortran. This method is useful when a complex equation is not encountered frequently. Variables may be changed and a new answer obtained without re-entering the equation or unchanged data. An alternate approach is to maintain routines in storage for the solution of frequently encountered problems. The user specifies the routine and enters data. A few examples are:

- Series solution of integrals
- Determinant reduction
- Optimization formulas
- Vector analysis
- Differential equations.

On-Line Computer Programming

Time-sharing also offers a new approach to the preparation of programs. The programmer writes the program at the terminal and enters the coded program into the computer at the same time. When he is satisfied that all needed changes have been made, a source deck might be punched by the computer. Or, the coded program could be assembled, and errors discovered by the assembler reported to the terminal. An object deck may be punched after a satisfactory assembly.

Document generation may also be aided by time-sharing techniques. Specialized, intermittently encountered documents, including those requiring computation, fall into this area.

Information retrieval applications of time-sharing offer another method for freeing people from the time-consuming clerical aspect of creative work.

The computer can replace the libraries of catalogs and, more importantly, the indexes of catalogs used to maintain reference material. A simple example is the card catalog of a library. Entries are coded by subject, author, and title. Such a method is readily adaptable to a time-sharing system. This type of cataloging is common throughout the business, scientific, engineering, academic, and governmental worlds. A computer time-sharing system can provide fast response, easy updating, and convenient remote inquiry.

Text Handling

These terminals are used in a new approach to the production of large-volume transcriptions. Text handling is a specialized application of the time-sharing concept. Text that has been typed and entered into accessible storage is proofread and edited. The typist then revises the stored text as required with deletion and insertion facilitated by the computer. A copy of the updated draft or parts of it may be requested from the computer after each iteration. Manual retyping of corrected drafts and final text is eliminated. Some areas of application are:

- Technical writing
- Publishing
- Proposal writing
- System and procedure documentation
- Specification writing for engineering and purchasing
- Price list
- Contract preparation and management
- Legal drafts
- Legislative bill drafts
- Sales catalog maintenance
- Computer program writing

The 2741 and System/360 combination makes possible corrections using addressable text storage. This method increases efficiency and accuracy in the preparation of documents that may contain highly technical material. Since such text must be absolutely accurate, careful proofreading and correction are required. However, once the accurate text is stored, additions and corrections can be easily accomplished. The entire page need not be typed or proofread again. Since any original errors are easily corrected, the initial text requires less re-typing. Output typically requiring accuracy and frequent updating includes:

- Purchase orders

- Personnel records
- Manufacturing orders
- Engineering change orders
- Executive correspondence
- Data file maintenance.

Typed data can be stored in direct-access storage when it is not being acted upon in core storage. Text retrieval would then be simple and the response fast. Controlled accuracy and increased production of prechecked form-letter statements and tables are ideal for applications such as:

- Price quotations
- Sales promotions and other form letters

- Accounts receivable follow-up
- Audit correspondence
- Acknowledgment letters.

These examples are by no means exhaustive. Any body of text or data may be more efficiently handled by entering it into a computer for storage, editing, or processing if it is desirable to:

- Format
- Edit
- Assemble
- Maintain accuracy
- Make changes over a period of time.

IBM 2741 COMMUNICATIONS TERMINAL DESCRIPTION

The IBM 2741 Communications Terminal is the combination of an IBM Selectric® typewriter and the necessary control equipment for transmission over a communication line. The control equipment is located in the back of the typewriter stand (see Figure 3). The only control switch that is not part of the keyboard is the terminal mode switch. This switch is located on the left side of the typewriter stand.*

The Selectric® typewriter also has the following features:

- 10 or 12 characters-per-inch horizontal spacing (10 pitch is standard)
- 15 1/2-inch paper-width capacity
- 13-inch-wide writing line with a standard platen pin-feed platen (available as a special feature)

- 6 or 8 lines-per-inch vertical spacing (6 lines is standard).

IBM 2741 Keyboard

The 2741 keyboard is physically identical to the standard IBM Selectric® typewriter (Figure 3). Functionally, one change has been made to the keyboard. The Selectric typewriter index key is now labeled ATTN (attention).* The indexing (line-spacing) function is initiated only by the computer.

*A detailed description of the keyboard controls, transmission controls, switches, and typewriter paper controls can be found in the IBM 2740/2741 Communications Terminals--Operator's Guide, Form A27-3001.

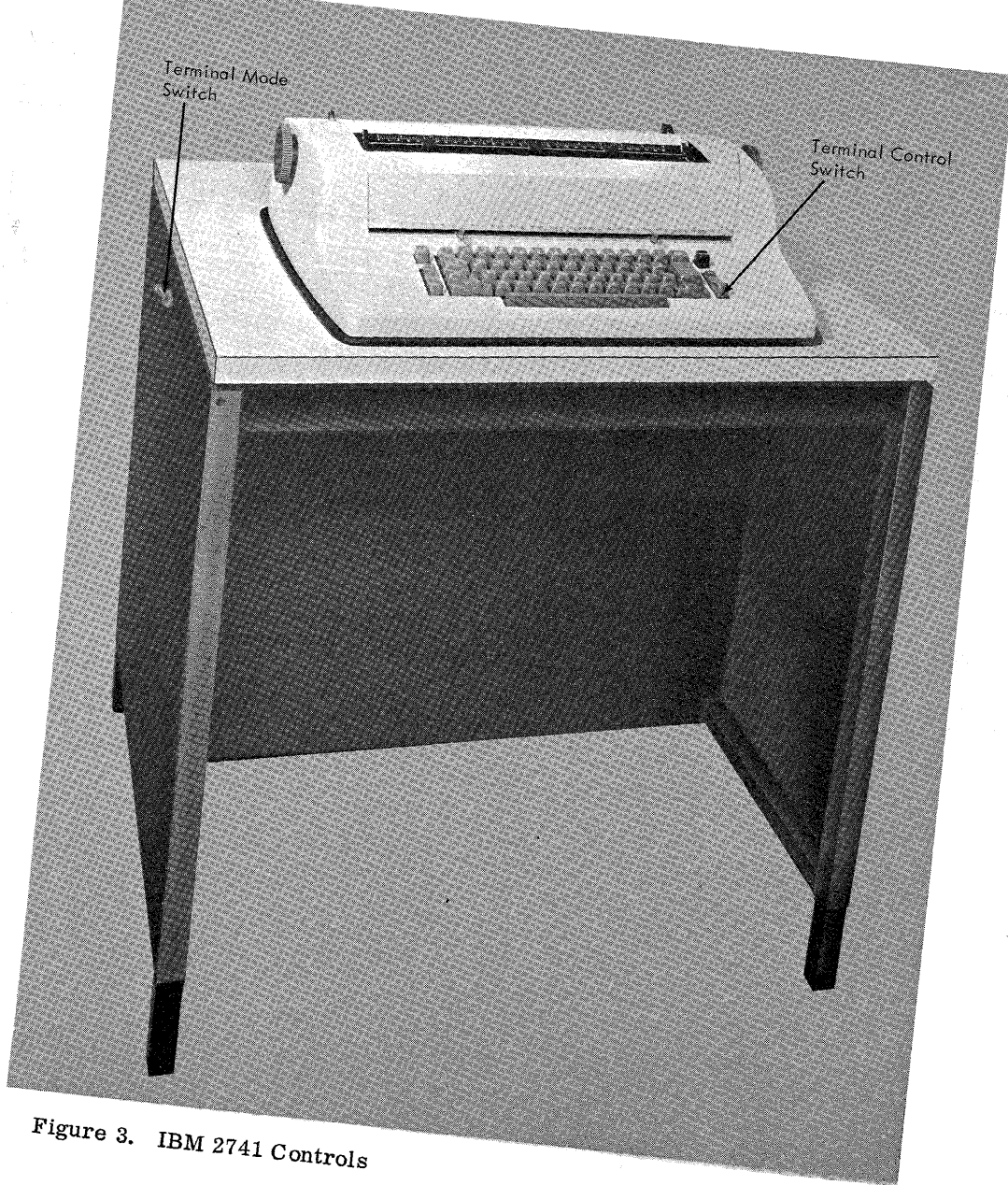

Figure 3. IBM 2741 Controls

General Operation

The simplicity of operation of the IBM 2741 means that the user need not be trained to use a computer. Anyone who types can use this device. The user's attention is devoted to the content of the material--not the operation of the machine. The details of machine operation are under the control of the computer. Simple request sequences are used to specify the operation desired. The request sequences and possible operations are determined by the program that controls the computer.

Modes of Operation

The 2741 Communications Terminal has two modes of operation: communicate mode and local mode. The mode of the terminal is controlled by the terminal mode switch, which is located on the left side of the typewriter stand (see Figure 3).

When in local mode, the terminal is disconnected from the communication line to the computer. The terminal can be used for typing, just as any other Selectric typewriter. Nothing can be transmitted or received.

When switched to communicate mode, the terminal is initially placed in a control-receive state. The print element is automatically shifted to lower case, if necessary, and the terminal then goes to the communicate-transmit state. A \textcircled{D} code is automatically sent to the computer and the keyboard unlocks. The operator may now type whatever requests and text are desired. (See To Transmit and Receive, in the IBM 2741 Terminal Operation section of the IBM 2740/2741 Communications Terminals--Operator's Guide, Form A27-3001.) Terminal transmission is ended by operating either the attention key or the carrier return key, both of which cause a \textcircled{C} to be sent to the computer.

The basic indication of the terminal state (transmit or receive) is the keyboard. The keyboard is locked whenever the terminal is not in transmit state. Receive-control is another momentary state in which the keyboard is locked and the terminal is waiting for a \textcircled{D} from the computer. Receipt of the \textcircled{D} code places the terminal in a receive state. An automatic lower-case shift occurs in the receive-control state if required.

IBM 2741 Line Control

Line control becomes effective on the 2741 as soon as the terminal power switch is turned on and the

terminal mode switch is set to communicate. The terminal is automatically put in the transmit state and a \textcircled{D} code sent to the computer. The operator may transmit by keying as on a typewriter (see To Transmit and Receive, in the IBM 2741 Terminal Operation section of the IBM 2740/2741 Communications Terminals--Operator's Guide, Form A27-3001.)

Terminal transmission ends when the terminal transmits a \textcircled{C} . The \textcircled{C} is transmitted when the attention key or the carrier return key is operated. However, when the carrier return key is operated, a carrier return code precedes the \textcircled{C} code. The transmission of the \textcircled{C} code places the terminal in the receive-control state and the keyboard is locked, waiting for a \textcircled{D} code from the computer.

Upon receipt of the \textcircled{C} code, the computer transmits a \textcircled{D} code and the terminal is placed in the receive state. Any valid character code received from the computer causes printing. At the end of transmission the computer sends a \textcircled{C} code to the terminal.

The receipt of a \textcircled{C} code from the computer causes the terminal to switch to transmit mode. The keyboard is unlocked and the terminal automatically transmits a \textcircled{D} code.

Figure 4 shows a typical line-control sequence. The sequence may be ended only by the terminal. The operator terminates line control by switching to local mode or by turning the terminal power switch off. Transmissions with the 2741 terminal are not checked for vertical or longitudinal redundancy. NOTE: See Code Charts and Keyboard Arrangements section in this manual for a description of the \textcircled{C} and \textcircled{D} codes.

Programming Considerations

The operations available to the IBM 2741 user are determined by the program that controls the computer. The facilities of the computer may be made available to the 2741 user. Computation, high-speed speed printing, card punching, or magnetic-tape writing of stored information may be included in the program.

The computer must be programmed to service many terminals. As the typist composes (or copies) at her own speed, the characters are entered into storage. When information is transmitted to the terminal, the computer "types" at the maximum speed of the terminal. There must be a method of sandwiching (interleaving) these terminal service functions between the time devoted to what-

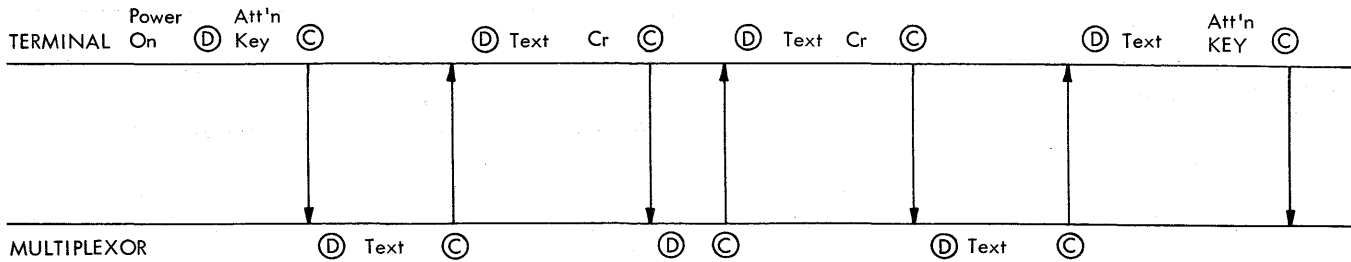

Note:
See Code Chart and Keyboard Arrangement section in this manual for a description of the (D) and (C) codes.

Figure 4. IBM 2741 Line Control

ever data manipulation is required by the application.

The extent of the program is limited by the size of the computer. A highly developed program for publishing, for example, might accept rough drafts, facilitate editing, and finally print out pages with two columns, justified margin, page numbers, running feet, and spaces for figures. Another program might handle engineering specifications, purchase orders, technical manuals, and new computer programs.

The particular printing element being used by the terminal is also of concern to the programmer. For instance, on the Courier 72 print element, the digit 1 and the ± symbol replace the] and the [respectively on the Manifold 72 element. One approach to this situation is to define a change-of-print-element code sequence in which the operator informs the computer of the print element being used.

Keyboard Considerations

The type of keyboard and print element to be used on the 2741 terminal typewriter can be specified when the terminal is ordered. The types available are the standard Selectric® typewriter (correspondence) keyboard and print element, used primarily for

text handling applications; and the PTTC/BCD or PTTC/EBCD keyboard and print element, used in on-line computation or programming applications.

Since the line code assignments of the graphics used with the standard Selectric typewriter keyboard differ from those used with the PTTC/BCD or PTTC/EBCD keyboard, the processor program must be designed to accept the particular assignments.

Timing Considerations

The program must allow time for the mechanical functions of the terminal to take place. This is done by inserting idle codes for the time required. Any code which is ignored by the terminal may be used. Common practice is to use the BCD idle code (B8421).

The number of idle codes required for each mechanical operation is as follows, where N is the number of idle codes required, and T is the number of inches of carrier travel; round off the result to the next higher whole number.

Carrier return: $N = T + 1.5$
Tab: $N = T + 1.5$
Index: $N = 1$

If the program uses the opportunity to transmit when offered by the (C) that follows each carrier return, time must be allowed for the carrier return to be completed before transmission begins.

Typamatic Keys

The Typamatic keys are the space bar, backspace key, and hyphen/underscore key. If one of these keys is operated normally, the corresponding function occurs once. If the key is pressed and held, the action is repeated until the key is released.

Receive Interrupt

The Receive Interrupt feature allows the 2741 operator to interrupt computer transmission. If this feature is installed, the Attention key is active when the terminal is receiving text. The operator presses the Attention key to cause an interrupt. This causes the 2741 to transmit a 200 to 360ms continuous space signal. This signal requests that the computer program end transmission by transmitting a ©. The program may or may not honor this request. If transmitted by the CPU, the © places the 2741 in transmit mode. The terminal then transmits a Ⓓ and its keyboard unlocks.

Data printed on the line during which the interrupt occurs may not be identical to the data transmitted from the CPU. For this reason, the interrupt should be considered a terminating condition that voids the entire print line.

Communications facilities for 2741's using Receive Interrupt must have duplex capability (simultaneous two-way transmission).

Transmit Interrupt

The Transmit Interrupt feature allows the computer to interrupt 2741 transmission. To interrupt, the CPU transmits a continuous space signal. The duration of the space signal is set by the CPU programmer in increments of a character time and must be a minimum of three character times (more than 200ms). (A minimum of one character time of mark signal, transmitted automatically by the IBM 2702 or 2703, must follow the space signal.) Reception of the space signal causes the 2741 to change to receive control mode and await a Ⓓ or © from the CPU.

NOTE: An interrupt signal received by a 2741 which is not in transmit mode causes unpredictable results.

Data printed on the line during which the interrupt occurs may not be identical to the data transmitted to the CPU. For this reason, the interrupt should be considered a terminating condition that voids the entire line.

Communications facilities for 2741's using Transmit Interrupt must have duplex capability (simultaneous two-way transmission).

Print Inhibit

The Print Inhibit feature enables the CPU to inhibit printing at the 2741. A bypass code (A 8 4) received by the 2741 initiates the inhibiting function. When in the print inhibit mode, all printable characters received or keyed at the 2741 are recognized and cause the print element to function, but no printing takes place.

Printing is inhibited until a restore code (B 8 4) is received to reset the inhibiting function. The print inhibit function is also reset by a power-on sequence.

Dial Up

The Dial-Up feature allows the 2741 to be attached to a common-carrier switched network. A Western Electric Data Set 103A1 or 103A2 (or equivalent) is required to attach the terminal to the common-carrier switched network.

To establish connection with the computer, the terminal operator places the data set in talk mode, dials the telephone number of the computer in the conventional manner, listens for an answer tone from the computer, then places the data set in the data mode. The connection is terminated either by turning terminal power off, or by returning the data set to talk mode.

Pin-Feed Platens

Pin-feed platens are available in the following inch sizes to replace the standard friction-feed platen on the IBM 2741 Communication Terminal Selectric Typewriter:

<u>Overall Forms Width</u>	<u>Hole-to-Hole Width</u>	<u>Writing Line</u>
5 3/4	5 1/4	4 3/4*
6 1/2	6	5 1/2
8	7 1/2	7
8 1/2	8	7 1/2
9 1/2	9	8 1/2
9 7/8	9 3/8	8 7/8*
10 3/8	9 7/8	9 3/8*
10 1/2	10	9 1/2
10 5/8	10 1/8	9 5/8
11 3/4	11 1/4	10 3/4
12	11 1/2	11
13	12 1/2	11 7/8
13 5/8	13 1/8	12 5/8
14 3/8	13 7/8	13

*Available in six lines-per-inch only

Continuous forms used with pin-feed platens should be edge stapled, glued, or stitched. The number of copies that can be satisfactorily printed depends on paper and carbon thickness, and on the height from which the forms are fed. A maximum of an original and four copies can be printed.

COMMUNICATIONS CONSIDERATIONS

The IBM 2741 Communications Terminal communicates with the computer (multiplexor) on either privately owned or leased common-carrier communications facilities. One communications line is required for connecting each 2741 to the multiplexor.

IBM Line Adapter (Limited Distance Type 1)

This feature permits the customer to attach an IBM 2741 Terminal to customer-installed communications lines or leased common-carrier private line channels. The line adapter feature (installed within the 2741) provides the necessary signal

modulation and demodulation for transmission on two-wire or four-wire communications lines up to 4.75 miles in length with a single 2741 attached. Two versions of this line adapter are available: Type 1A for two-wire systems, and Type 1B for four-wire systems.

IBM Line Adapter (Limited Distance Type 2)

This feature permits the customer to attach an IBM 2741 Terminal to customer-installed communications lines or leased common-carrier private line channels. The line adapter feature (installed within the 2741) provides the necessary signal modulation and demodulation for transmission on two-wire communications lines up to 8.0 miles in length.

IBM Line Adapter (Leased Line)

This feature permits the customer to attach an IBM 2741 Terminal to a leased common-carrier private line or equivalent privately owned facility. This line adapter feature (installed within the 2741) provides the necessary signal modulation and demodulation for transmission on a communications line without length restriction.

IBM Line Adapter (Shared Line)

This feature permits the customer to attach an IBM 2741 Terminal to one of four subchannels which can be obtained from either the customer's privately owned or leased common-carrier telephone-grade communications facilities. This line adapter also provides the necessary signal modulation and demodulation required for data communications. With this feature, one telephone line can provide up to four separate paths for simultaneous data transmission. This line adapter is available for operation on either two-wire or four-wire communications facilities. NOTE: For additional information on the use of IBM line adapters, see Planning and Installation of a Data Communications System Using IBM Line Adapters, Form A24-3435.

Figures 5 and 6 illustrate the standard IBM Selectric® typewriter keyboard arrangement and corresponding transmission codes employed when the terminal is used for normal correspondence and text type operations. Additional keyboard arrangements and print elements are available that provide compatibility with the PTTC/BCD and PTTC/EBCD codes. These keyboard arrangements and codes are normally used in time-sharing applications. The PTTC/BCD and PTTC/EBCD code charts and corresponding standard keyboard arrangements are shown in Figures 7, 8, 9, and 10. The choice of keyboard must be made when the 2741 is ordered. Although the PTTC/BCD and PTTC/EBCD print elements are interchangeable with each other, they are not interchangeable with the standard

Selectric typewriter print element (see Note-- Figure 5).

The line code assignments for the two line control codes used with the 2741 are (C 8421) for the EOT (C) and (821) for the (D). The (C) code is unique and has no graphic associated with it. The (D), on the other hand, has the same line code assignment as the digit 9 (lower case) and left parenthesis (upper case) on the standard Selectric typewriter keyboard arrangement. Its corresponding graphics on the PTTC/BCD and PTTC/EBCD keyboard arrangements depend upon the code and character set used (see Figures 8 and 10). The (821) code will print only when received or transmitted in the text mode, and not when used as a line control character.

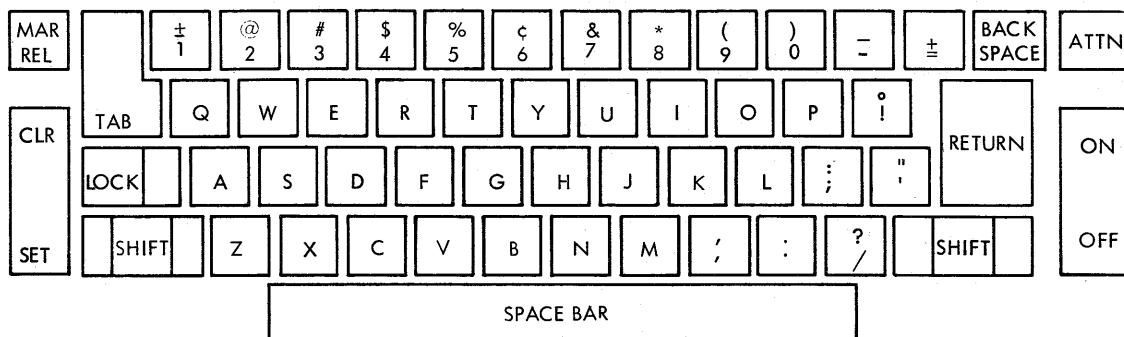

Note: When this keyboard and associated print elements are specified the mechanical changes in the keyboard mechanism determine the line code assignments of the graphic characters. These arrangements are not compatible with the assignments provided by the use of the PTTC/BCD and PTTC/EBCD keyboards and associated print elements (see Code Chart, Figure 6).

Figure 5. Keyboard (Standard Selectric Typewriter)

LOWER CASE	Bit Value							UPPER CASE
	B	A	C	8	4	2	1	
.	B		C				2	.
/	B	A	C			4	1	:
,	B	A				4	2 1	,
'	B		C			4		"
!	B							°
=	B	A					2	+
-	B	A		8			2 1	-
/	B	A		8				?
1/3							1	±/∓
2							2	@
3			C				2 1	#
4				8				\$
5					4			%
6			C		4	2		¢
7			C		4		1	&
8					4	2 1		*
*9				8			2 1	(
0			C	8			1)
a	B		C		4	2 1		A
b		A	C	8			2 1	B
c		A	C		4	2 1		C
d		A			4		1	D
e		A	C		4			E
f	B	A	C				2 1	F
g	B	A					1	G
h		A		8			1	H
i	B				4	2		I
j	B	A	C					J
k		A			4	2		K
l		A	C	8				L
m	B		C				1	M
n		A	C				2	N
o	B		C	8				O
p	B	A			4			P
q	B	A	C		4	2		Q
r	B				4		1	R
s	B			8			1	S
t		A						T
u		A				2 1		U
v	B					2 1		V
w	B		C	8		2 1		W
x		A	C				1	X
y	B	A	C	8			1	Y
z			C	8		2		Z

THE CODES BELOW ARE NOT PRINTABLE									
FUNCTION CODES				MEANING					
PN			C	8	4		Punch On		
BY		A		8	4		Bypass		
RES		B		8	4		Restore		
PF		B	A	C	8	4	Punch Off		
RS				8	4	1	Reader Stop		
LF		A	C	8	4	1	Line Feed		
NL		B		C	8	4	1	New Line (Carrier Return and Line Feed)	
HT		B	A		8	4	1	Horizontal Tab	
UC				8	4	2	Upper Case		
EOB		A	C	8	4	2	End of Block		
BS		B		C	8	4	2	Backspace	
LC		B	A		8	4	2	Lower Case	
*EOT			C	8	4	2	1	End of Transmission	
PRE		A		8	4	2	1	Prefix	
IL		B		8	4	2	1	Idle	
DEL		B	A	C	8	4	2	1	Delete
Space			C					Space	

*See Code Charts and Keyboard Arrangements section in this manual.

Figure 6. Line Code Chart (Standard Selectric Typewriter Print Element)

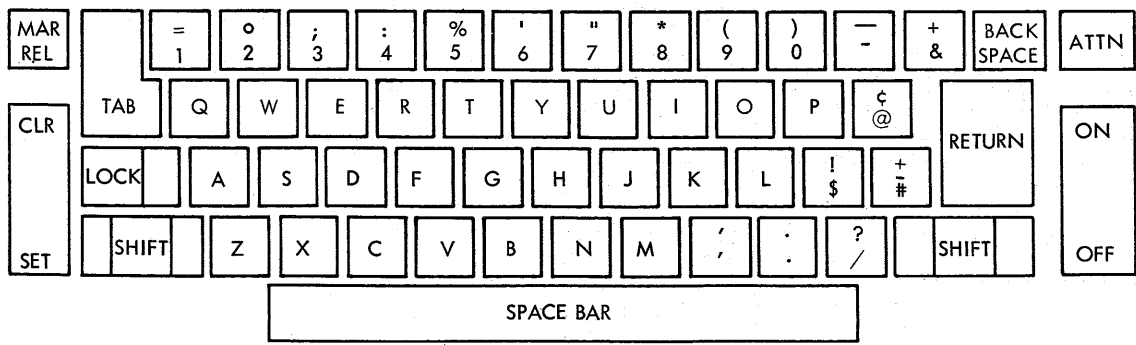

Figure 7. Keyboard (PTTC/BCD)

LOWER CASE				Bit Value								UPPER CASE			
CHARACTER SET												CHARACTER SET			
Std.	A	H	Typ.	B	A	C	8	4	2	1	Std.	A	H	Typ.	
.				B	A		8		2	1	.				
\$				B		C	8		2	1	!			:	
,				A		C	8		2	1	,				
**	=						8		2	1	±		#	"	
@	'	1/2		A							¢		Δ	1/4	
&	+	=		B	A	C					+		<	+	
-				B							-		\	-	
/				A	C					1				?	
1										1	=		>	±	
2								2			°)	@	
3						C			2	1	:		#	\$	
4							4				:		¢	\$	
5						C		4		1	%		(%	
6						C		4	2		'		:	¢	
7							4	2	1				"	&	
8							8						*		
9						C	8			1	([(
0						C	8		2)])	
a				B	A					1				A	
b				B	A				2					B	
c				B	A	C			2	1				C	
d				B	A			4						D	
e				B	A	C		4	2	1				E	
f				B	A	C		4	2					F	
g				B	A			4	2	1				G	
h				B	A		8							H	
i				B	A	C	8			1				I	
j				B		C				1				J	
k				B		C			2					K	
l				B				2	1					L	
m				B		C		4						M	
n				B				4		1				N	
o				B				4	2					O	
p				B		C		4	2	1				P	
q				B		C	8							Q	
r				B			8			1				R	
s					A	C			2					S	
t					A				2	1				T	
u					A	C		4						U	
v					A			4		1				V	
w					A			4	2					W	
x					A	C		4	2	1				X	
y					A	C	8							Y	
z					A		8			1				Z	

THE CODES BELOW ARE NOT PRINTABLE														
FUNCTION CODES										MEANING				
PN						C	8	4						Punch On
BY					A		8	4						Bypass
RES					B		8	4						Restore
PF					B	A	C	8	4					Punch Off
RS							8	4		1				Reader Stop
LF					A	C	8	4		1				Line Feed
NL					B		C	8	4	1				New Line (Carrier Return and Line Feed)
HT					B	A		8	4		1			Horizontal Tab
UC							8	4	2					Upper Case
EOB					A	C	8	4	2					End of Block
BS					B		C	8	4	2				Backspace
LC					B	A		8	4	2				Lower Case
*EOT						C	8	4	2	1				End of Transmission
PRE					A		8	4	2	1				Prefix
IL					B		8	4	2	1				Idle
DEL					B	A	C	8	4	2	1			Delete
Space						C								Space

*See Code Charts and Keyboard Arrangements section in this manual.

Figure 8. Line Code Chart (PTTC/BCD)

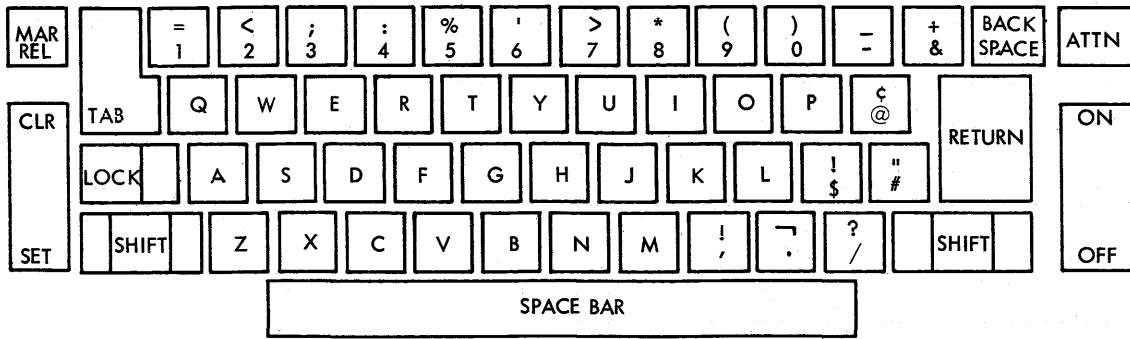

Figure 9. Keyboard (PTTC/EBCD)

LOWER CASE	Bit Value							UPPER CASE
	B	A	C	8	4	2	1	
.	B	A		8		2	1	~
\$	B		C	8		2	1	
,		A	C	8		2	1	
*#				8		2	1	"
@		A						¢
&	B	A	C					+
-	B							-
/		A	C				1	?
1							1	=
2						2		<
3			C			2	1	;
4				4				:
5			C	4			1	%
6			C	4	2			'
7				4	2	1		>
8				8				*
9			C	8			1	(
0			C	8		2)
a	B	A					1	A
b	B	A				2		B
c	B	A	C			2	1	C
d	B	A		4				D
e	B	A	C	4			1	E
f	B	A	C	4	2			F
g	B	A		4	2	1		G
h	B	A		8				H
i	B	A	C	8			1	I
j	B		C				1	J
k	B		C			2		K
l	B					2	1	L
m	B		C	4				M
n	B			4			1	N
o	B			4	2			O
p	B		C	4	2	1		P
q	B		C	8				Q
r	B			8			1	R
s		A	C			2		S
t		A				2	1	T
u		A	C	4				U
v		A		4			1	V
w		A		4	2			W
x		A	C	4	2	1		X
y		A	C	8				Y
z		A		8			1	Z

THE CODES BELOW ARE NOT PRINTABLE								
FUNCTION CODES				MEANING				
PN			C	8	4			Punch On
BY		A		8	4			Bypass
RES	B			8	4			Restore
PF	B	A	C	8	4			Punch Off
RS				8	4		1	Reader Stop
LF		A	C	8	4		1	Line Feed
NL	B		C	8	4		1	New Line (Carrier Return and Line Feed)
HT	B	A		8	4		1	Horizontal Tab
UC				8	4	2		Upper Case
EOB		A	C	8	4	2		End of Block
BS	B		C	8	4	2		Backspace
LC	B	A		8	4	2		Lower Case
*EOT			C	8	4	2	1	End of Transmission
PRE		A		8	4	2	1	Prefix
IL	B			8	4	2	1	Idle
DEL	B	A	C	8	4	2	1	Delete
Space			C					Space

*See Code Charts and Keyboard Arrangements section in this manual.

Figure 10. Line Code Chart (PTTC/EBCD)

Some of the terms used in the data processing and communications fields have specialized meanings. The following definitions may be useful.

Data Set: a modulation/demodulation device designed to provide compatibility between input/output equipment and communications facilities.

Demodulation: the conversion of audio-frequency signals from a communications line to digital signals for a business machine.

Direct-access storage: in data processing, a storage medium for data in which the data is available for immediate retrieval, that is, not serial-access storage.

Full-duplex: a communication channel capable of transmitting in both directions simultaneously.

Half-duplex: a communication channel capable of transmitting in both directions, but in only one direction at a time.

Modem: another name for data set.

Modulation: the conversion of digital signals from a business machine to audio-frequency signals for transmission over communications lines.

Non-switched line: a communications line devoted to one user, that is, not part of a switched network; a leased private line or privately owned line.

On Line: associated with a processor either directly or through a transmission control unit. The physical connection can be accomplished by either multiwire cable or a communications line.

Program: the series of instructions, meaningful for a computer's control unit, that define, step by step, the operation of the computer for the solution of a given problem.

Switched Line: a communication line used by more than one user (customer); part of a switched network.

Terminal: a machine or group of machines capable of generating and/or receiving signals to be transmitted on and/or received from a communications line.



International Business Machines Corporation
Data Processing Division
1133 Westchester Avenue, White Plains, New York 10604
(U.S.A. only)

IBM World Trade Corporation
821 United Nations Plaza, New York, New York 10017
(International)