

card-programmed electronic calculator

**model A1 using
machine types 412-418,
605, 527, and 941**

third revision

I N T E R N A T I O N A L B U S I N E S S M A C H I N E S

IBM card-programmed
electronic
calculator

model A1 using
machine types 412-418,
605, 527, and 941

principles of operation

third revision

I N T E R N A T I O N A L B U S I N E S S M A C H I N E S

MAJOR REVISION (October 1954)

This edition, Form 22-8686-3, obsoletes Form 22-8686-2 and all earlier editions. Significant changes have been made throughout the manual, and this new edition should be reviewed in its entirety.

Copyright 1951, 1952, 1954 by
International Business Machines Corporation
590 Madison Avenue, New York 22, N. Y.
Printed in U. S. A.
Form 22-8686-3

CONTENTS

GENERAL	5	PAYROLL APPLICATION	66
Machine Units	6	Planning Chart	69
Separated Machine Combinations	8	Control Panel Diagrams	70
OPERATING PRINCIPLES	11	Section One: Payroll Computations	71
Specifications	12	Section Two: Checking Features	90
412-418 Operating Switches and Signals	13	TYPE 527 CONTROL PANEL	101
527 Operating Switches and Signals	14	Summary Punch Control	101
605 Operating Switches and Signals	16	AUTOMATIC ADVANCE OF FIELD SELECTOR LEVELS	102
Control Panel	17	GENERAL PURPOSE SETUP OF THE CPC	103
Standard CPC Control Panel Features	20	Sign Control Summary	106
PRINCIPLES OF CONTROL PANEL WIRING	23	Reading into the 605	106
Read-in—Calculate—Print	23	Reading into 412-418 Counters	106
Selective Read-in to the Calculator	28	Reading into the 941	107
Basic Arithmetical Operations	29	OPERATING SUGGESTIONS	108
Field Selector	35	Summary of Steps for Placing CPC in Operation	108
Top Counter Read-out	39	Power Supply Connections	108
PRINCIPLES OF 941 STORAGE UNIT	40	Blank Card in 412-418 Card Feed	108
Read-in from the Card	41	605 Control Panel Wiring	108
Read-in from Electronic Counter	42	Program Source Filters	109
Storage Read-out	45	Calculator Selector Coupling Exit	111
Read-out on Program Cycles	45	Program Suppression	112
Storage Clear	48	Wiring between Control Panels	112
CHANNEL C SHIFT UNIT	49	DETERMINING MACHINE SPEED	113
SELECTORS	52	CONTROL PANEL SUMMARIES	115
CALCULATOR CONTROL PANEL WIRING	57	412-418 Control Panel	115
Additional Program Steps	57	605 Control Panel	121
Program Source Filters	60	527 Control Panel	124
Program Step Suppression	60	TIMING CHARTS	128
Suppression Filters	61	CPC Model A1	128
Group Suppression	61	Notes for 412-418 Timing Chart	128
Storage Assignment	62	Notes for 527 Timing Chart	132
Zero Test	62		

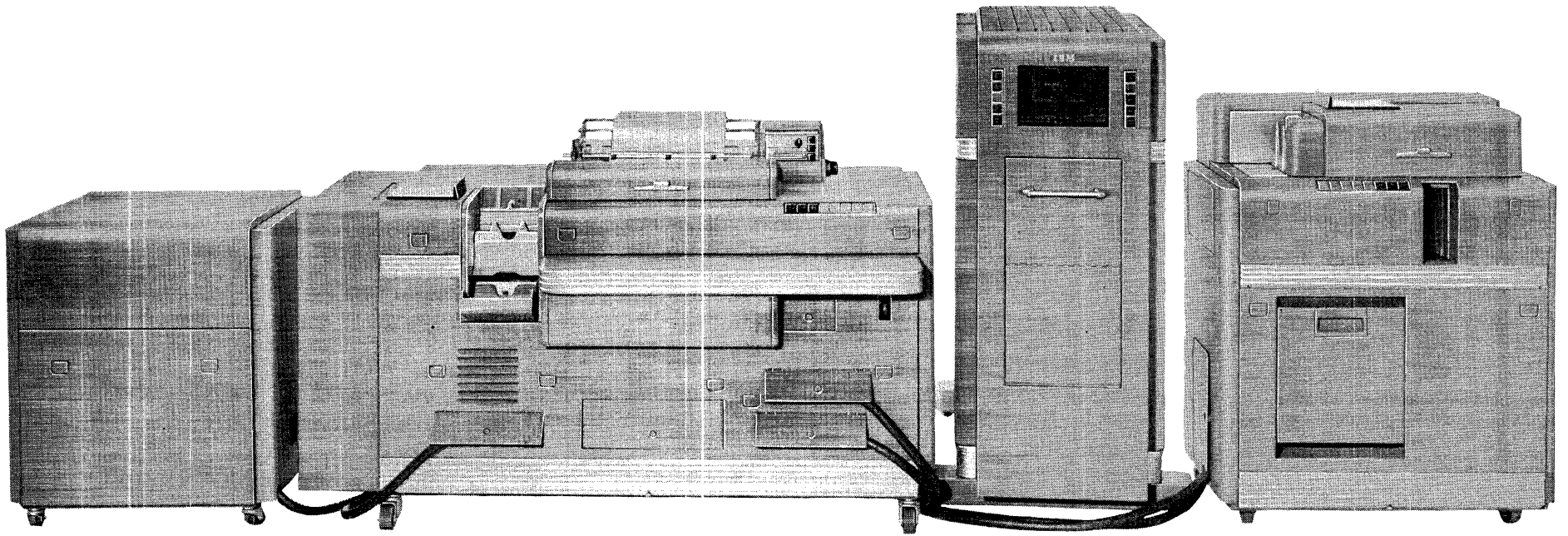

IBM CARD-PROGRAMMED ELECTRONIC CALCULATOR

IBM CARD-PROGRAMMED ELECTRONIC CALCULATOR

MODEL A1

THE IBM Card-Programmed Electronic Calculator is a versatile data-processing machine which has been performing equally well on accounting procedures and on mathematical and scientific problems. When used in accounting procedures, it is set up to operate in the same manner as other IBM Accounting Machines, with the additional feature that extensive calculations can be performed simultaneously with the printing of the finished report. The use of the CPC in an accounting procedure consolidates and reduces the number of machine and card operating steps required. This results in a saving of time and card handling.

Proven accounting applications of the CPC include:

- Financial statements
- Payroll
- Inventory control
- Parts requirements explosion
- Mortgage-table preparation
- Insurance
- Sales analysis
- Budget preparation
- Cost allocation

Engineering and scientific problems that the CPC has been successfully solving include numerical integration and differentiation, matrix multiplication and inversion, solution of simultaneous equations, evaluation of lengthy formulas, and the computation of special functions. To solve these types of problems, the CPC follows a prescribed sequence of instructions coded on Standard IBM punched cards.

When the CPC is used in accounting applications, it is set up in the same manner as other IBM machines

are set up for accounting work. That is, each application is wired on a separate control panel. A payroll application is wired on one panel, inventory application on another panel, and so on. This method of using the CPC is called a special-purpose setup. The special-purpose panel accomplishes a given job by the most efficient method and in a minimum of machine running time.

Scientific or engineering applications use the CPC in a different manner. A general-purpose control panel, capable of solving a variety of problems, is maintained. A number of different operations are wired into one set of control panels. These operations are selected by code punching in cards. Therefore, to solve a problem a set of instruction cards is punched. One card is punched for each operation. Thus the sequence of operations—the program—is determined by the instruction deck. As indicated by the name of the machine, its sequence of operations is card-programmed. To change from one job or problem to another, it is necessary to change only the program deck. Changes in control panel wiring are minimized when the CPC is set up as a general-purpose computer. The general-purpose setup results in longer machine running time for a given job than a special-purpose panel would require; however, this time is offset by eliminating the need of planning and wiring a new set of panels for each job.

Previous CPC Manuals and literature have thoroughly explained the general-purpose setup and techniques, and therefore will be minimized in this manual. The special-purpose method of using the CPC will be emphasized in this manual.

MACHINE UNITS

THE CPC consists of three, four, or more individual units interconnected by cables (Figure 1).

Accounting Machine	Types 412-418
Electronic Calculator	Type 605
High-speed Punch	Type 527
Auxiliary Storage Unit	Type 941

The accounting machine is similar to the Type 402 accounting machine; the calculator is similar to the Type 604 calculator. The Type 527 Punch is a combined calculating punch and an accounting machine summary punch. The Type 941 storage unit is a numerical storage unit and has capacity for storing 16, ten-position numbers. These four units constitute a basic CPC. One or two additional Type 941 storage units may be ordered to increase the numerical storage capacity. A three-unit CPC is also available; it

consists of the first three units listed above — the Types 412-418, 605, and 527 machines.

Many similarities exist between the CPC accounting machine and the Type 402 accounting machine. Likewise, similarities exist between the CPC calculator and the Type 604 calculator unit. However, the CPC units contain many modifications and have greater capacity and flexibility. The modifications include those required to allow the units of the CPC to operate in an integrated manner under control of the 412-418. They also permit independent use of the individual units, explained in another section of this manual.

Because the several units which comprise the CPC are, to a large extent, wired as they would be for separate operation, the Principles of Operation manuals for the 402 Accounting Machine and the 604 Electronic Calculating Punch must be studied before using this manual.

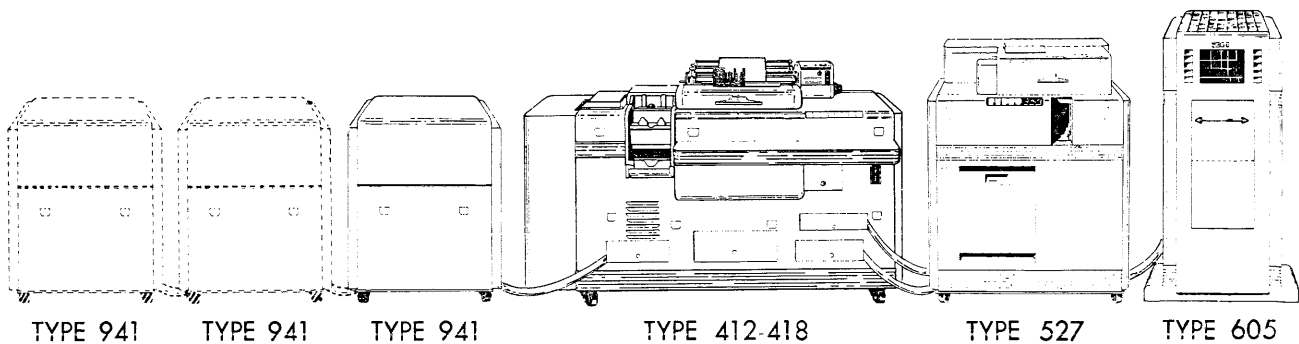
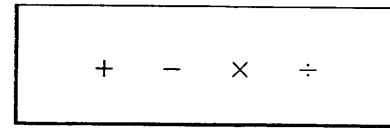
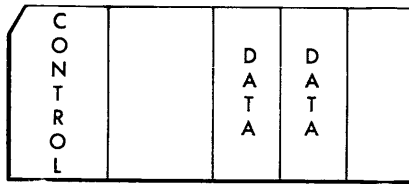

FIGURE 1. CPC MACHINE UNITS



Input

Punched IBM cards serve as the input to the machine. The card contains control punches and data fields. The control punches may be coded and punched in fields, or in some cases consist of X-punches. The control punches determine the operation to be performed and the location of input factors, as well as whether the output results will be printed, punched or stored.

The data fields contain the original factors to be printed, accumulated, sent to the calculator, or stored for future use.

Rate tables, schedules, mathematical tables, or tables of empirical data in the form of punched cards can be consulted by the machine.

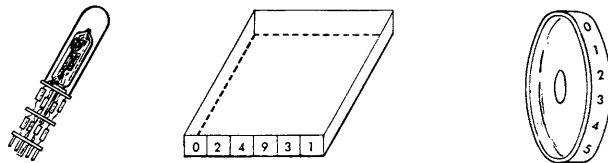

Storage

Three kinds of storage are provided to give the CPC flexibility:

Electronic storage in the Type 605 (50 positions)

Accumulating storage in the Type 412 (80 counters)

Digit storage in the Type 941 (160 positions in one unit, as many as 480 positions available in three Type 941 units)

Data from the cards may be entered into any of these storage units. Data may also be transferred between the storage units of the Type 605, 412, and 941 machines.

Arithmetic Unit

The arithmetic control unit, located in the 605, consists of high-speed electronic circuits. It will perform the basic operations of addition, subtraction, multiplication, division, balance test for positive or negative, zero test, and others.

In a payroll application, for example, the control panel is wired to compute piece work earnings, premium, gross, salary payroll, and so on. Arithmetical operations of crossfooting, multiplying, and dividing are included in each of these computations. The control punches in the card select the type of payroll computation desired.

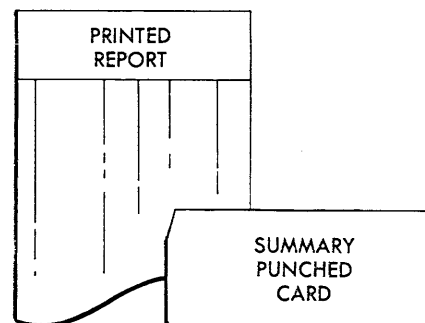

Output

The output from the CPC consisting of source data, intermediate, and final results, may be printed, or punched in IBM cards, or both.

Printed information may come from the storage units, the 412-418 counters, the electronic counter and general storage units, or IBM cards.

Results may be punched into IBM cards from the accumulating storage of the accounting machine, or from the general storage units and counter of the Type 605 machine. The punched cards may be used as input data to the calculator at a later time, and they may also be used for operations on other standard IBM equipment.

SEPARATED MACHINE COMBINATIONS

THE UNITS of the CPC may be used in various machine combinations. This provides additional flexibility for installations where the complete machine is not required for continuous operation. Individually the machines are of greater capacity than their standard companion units (such as Type 402, and 604). By combining these machines, much greater flexibility and capacity are available. When the Type 412 and Type 527 machines are used in separated combinations, the cables connecting these two machines *must* be disconnected. Special devices available on the 402 are, in most cases, available on the CPC.

412-418 Machine (Figure 2)

The Type 412-418 machine can be used alone to perform typical Type 402 operations. Conventional summary punches such as the Type 523 may be used with the 412 Accounting Machine.

The 412-418 machine provides full capacity Type 402 features *and*

- 60 additional pilot selectors
- 60 additional co-selectors
- field selector
- 10 coding selectors
- 5 latch selectors
- continuous emitter
- shift unit

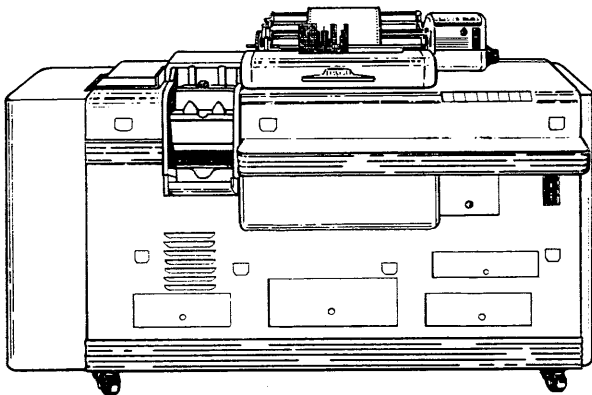

FIGURE 2. TYPE 412-418 ACCOUNTING MACHINE

412-527 Combination (Figure 3)

The Type 412 and 527 machines may be used as an accounting machine and summary punch. This combination provides all the Type 412 features plus summary punching. The Type 527 features that make it a more flexible summary punch are:

- punch selectors
- pilot selectors
- double-punch, blank-column detection
- 1/2 time emitter

412-527-941 Combination (Figure 4)

The Type 412-527-941 combination provides the accounting machine with the numerical storage capacity of the Type 941 unit. Information may be read from the card or 412 counters, and stored in the Type 941 register. It may be called out of the 941 to print on a report or accumulate in 412 counters. Thus, properly used, the 941 unit supplements and permits maximum utilization of 412 counters.

527-605 Combination (Figure 5)

The Type 527 punch and 605 calculator combination is more powerful than a standard 604 machine because it provides:

- 180 program exits
- unlimited calculate time
- program repeat
- 18 calculator selectors
- 10 repeat selectors
- group suppress units
- program expansion units
- zero test

527 Punch (Figure 6)

The Type 527 punch can be used alone as a gang-punch on applications similar to those handled by the Type 521 punch.

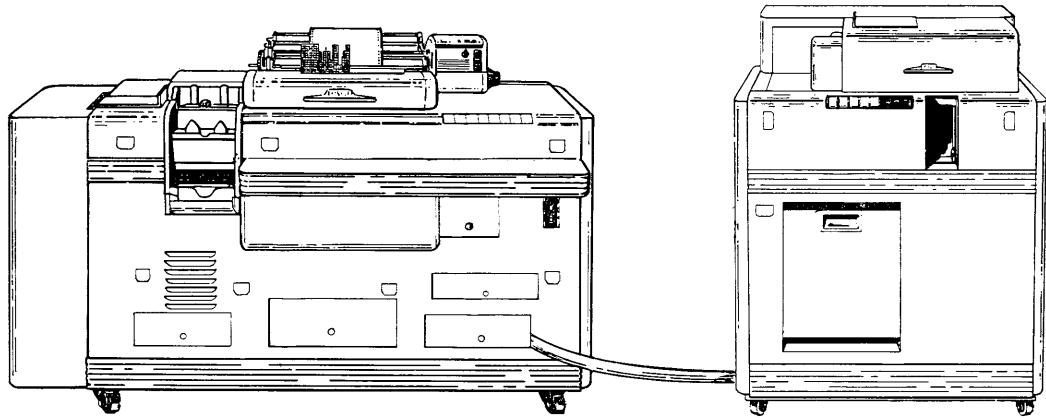

FIGURE 3. TYPES 412 AND 527 COMBINATION

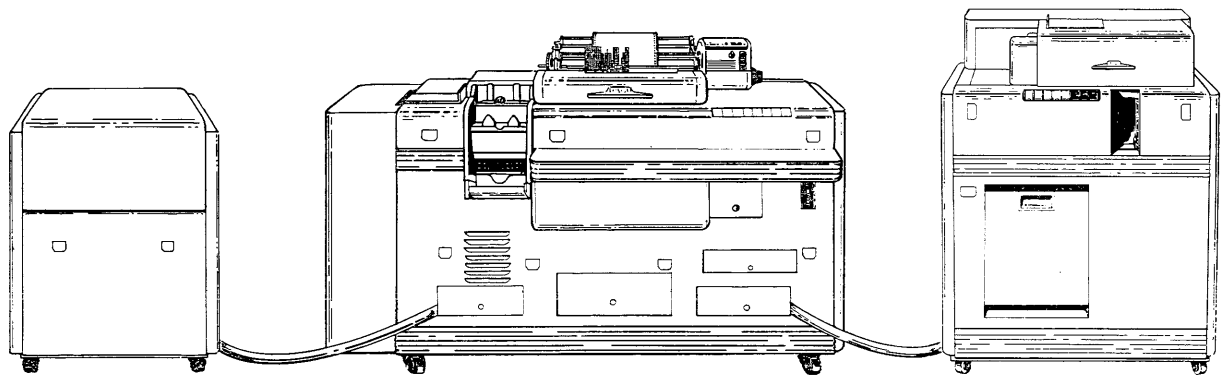

FIGURE 4. TYPES 412, 527 AND 941 COMBINATION

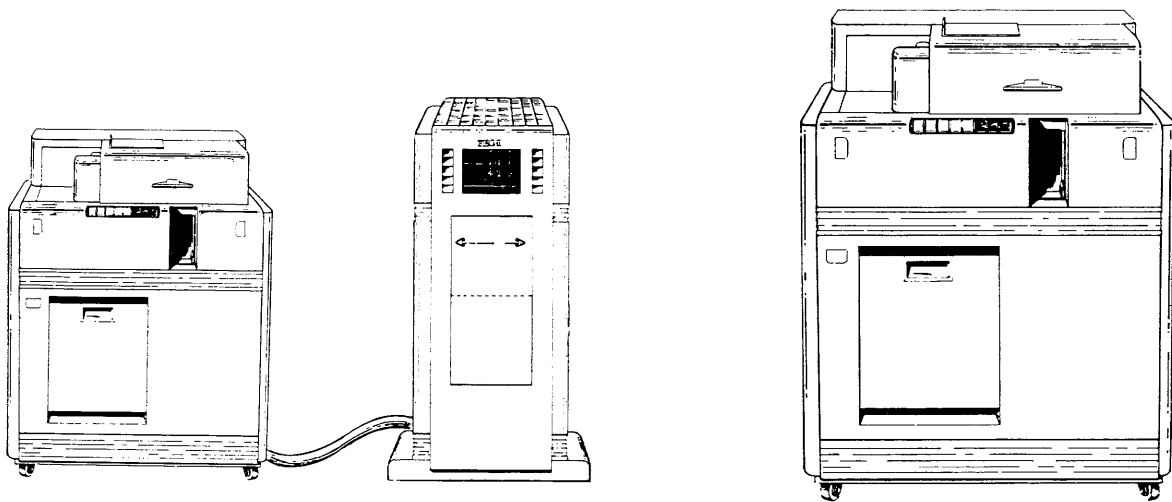

FIGURE 5. TYPES 605 AND 527 COMBINATION

FIGURE 6. TYPE 527 PUNCH

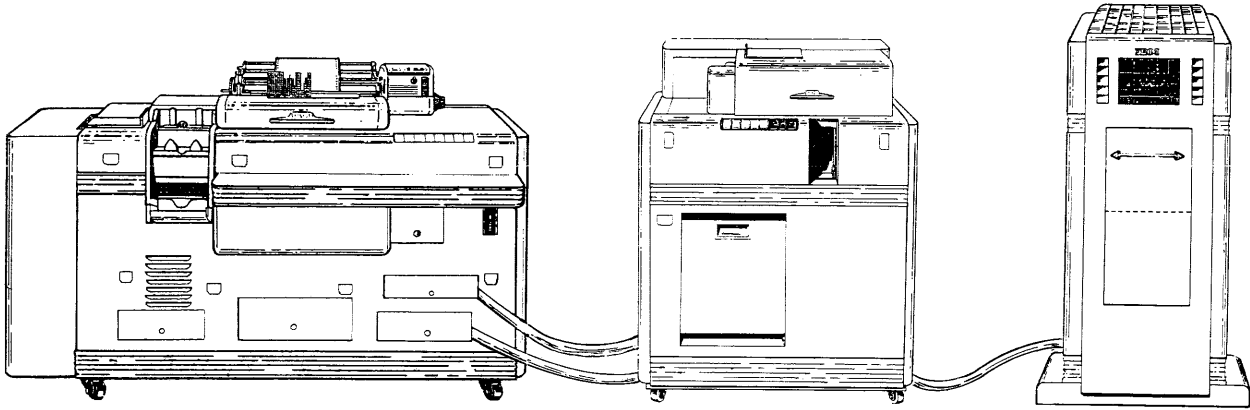

FIGURE 7. TYPES 412, 527 AND 605 COMBINATION

412-605 Combination (Figure 7)

The Type 412-605 Accounting-Calculating Machine Combinations must include the Type 527 whenever the calculator and accounting machine are used. It provides cable connections and a power supply for the calculator.

This combination is particularly well suited for accounting procedures because it allows extensive calculations to be made simultaneously with the preparation of the actual report. Cards may be summary-punched with information from both the accounting-machine counters or the calculator counter and general storage units.

OPERATING PRINCIPLES

THE TYPE 412-418 machine controls the CPC and serves as the input for control punches and data from the cards. Figure 8 shows a schematic of the feed, the two reading stations, and card path through the feed. Note that cycle 2 shows the card being read at the 2nd reading station, cycle 3 shows the card at 3rd reading, etc.

Figure 9 shows the same feed cycles laid out in a horizontal pattern.

The second reading station is used to pick up selectors and read control punches. This sets up the machine and selector networks for the next machine cycle.

Data fields or factors are read from the card as it passes the third reading station. It is at this time that factors are read into the calculator factor storage and general storage units. Factors read into the calculator may come from the card, or be read out of

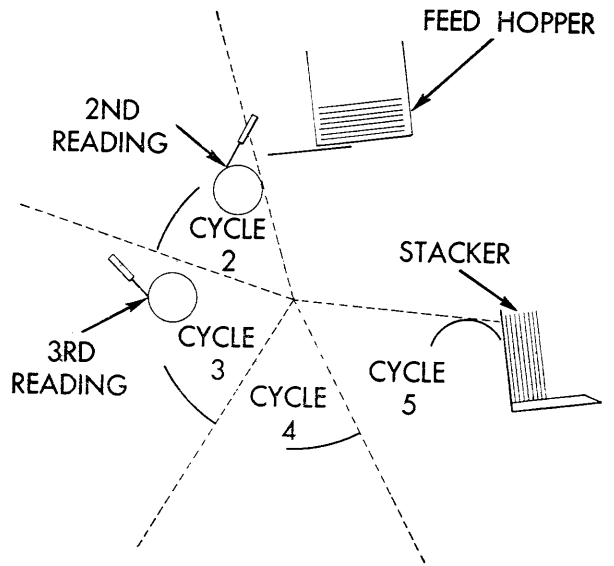

FIGURE 8. SCHEMATIC OF TYPE 412 FEED

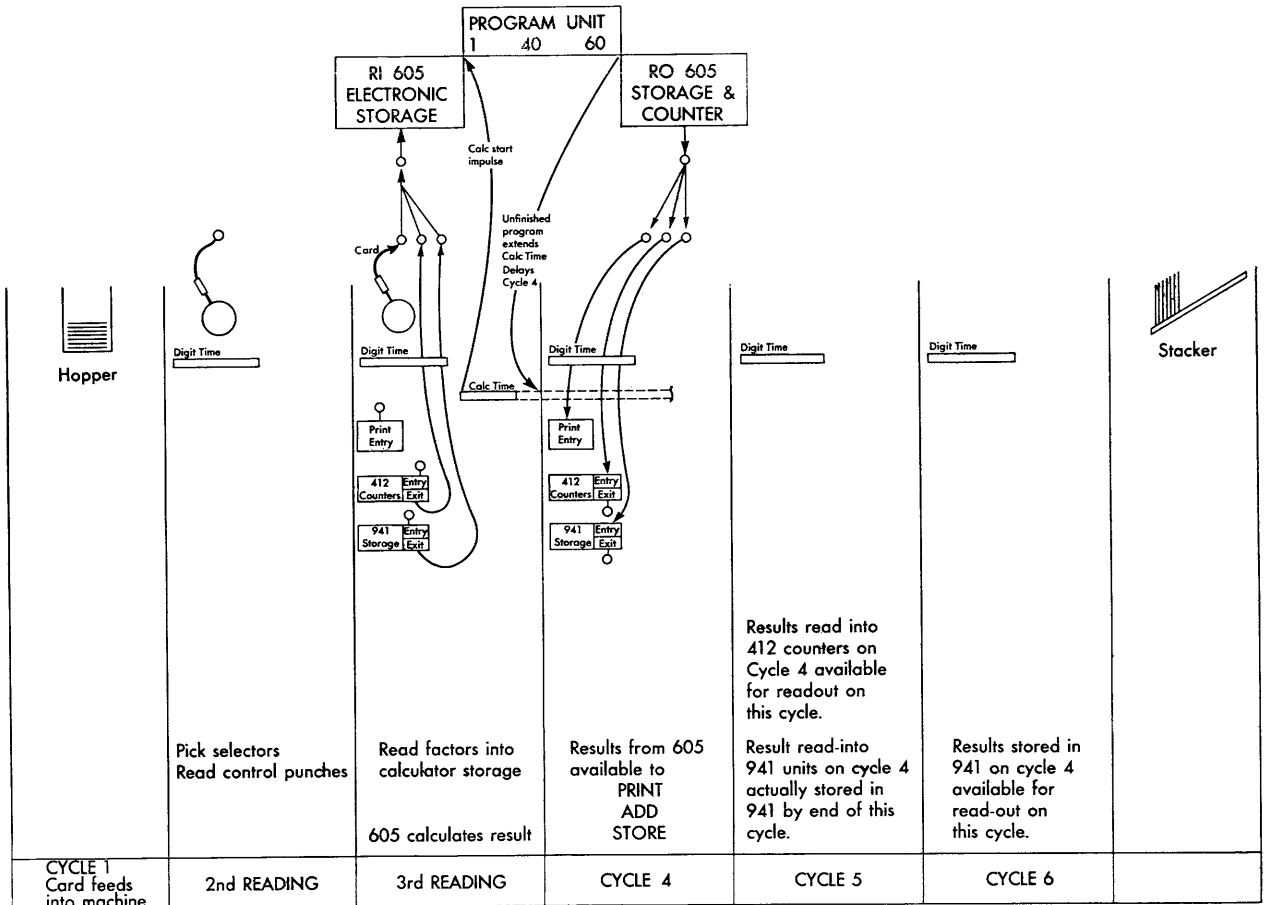

FIGURE 9. SCHEMATIC OF CPC CONCEPT

412 counters, or be read out of the 941 storage registers. Normal 402 wiring of card fields to print entry, or to add or subtract in counters also occurs on this cycle.

Calculating time begins in the latter part of the third reading cycle (195°). Somewhat later in the same cycle (275°) an unfinished program test determines one of two things, either:

- a. Calculating has been completed, signal the 412 machine to take the next active machine cycle.
- b. Calculating has NOT been completed, delay the 412 machine until the calculating is finished.

When calculation is finished, the results are available to the 412 machine at digit time in cycle 4. These results may be control-panel-wired to print, to accumulate in 412 counters, or to store in a 941 register.

Cycle 5 shows that information which was read in 412 counters on cycle 4 may be read out on the next cycle.

Cycle 6 shows that information sent to a 941 storage register on cycle 4 must not be read out of the same storage register until 2 cycles later. This is necessary because the 941 machine is an independent unit, and requires an additional cycle to transfer the factor from the 412 machine into the storage register. To summarize cycles 5 and 6:

- a. Type 412 counters may be wired to RO on the cycle following the read-in of information.
- b. A type 941 register may be told to read out two cycles after the cycle in which a read-in occurred.

The 941 storage units are more fully explained in another section of this manual.

Data fields or factors are often wired into the calculator from second reading. In these cases, the sequence of events shown in cycles 3, 4, 5, and 6 are moved up one cycle. Therefore, if the data enter the calculator from the card at second reading, the result is available on the 3rd reading cycle for printing or entry into 412 counters, etc.

SPECIFICATIONS

THE FOLLOWING table gives the space, weight and power requirements of the CPC components:

TYPE	LENGTH	WIDTH	WEIGHT	AC POWER	HEAT DISSIPATION
				SINGLE PHASE 60 CYCLE, 230 V	BTU'S PER HOUR 100% DUTY
412	75"	43"	2625 lb.	6.0A	5000
418	75"	43"	2553 lb.	6.0A	5000
527	40"	26"	785 lb.	3.2A	2190
605	53"	33"	1535 lb.	33.0A	19450
941	32"	26"	585 lb.	1.6A	1290

All the components of the CPC are plugged onto a single cable. The electric outlet, therefore, should supply 43.8 amperes at 230 volts, plus 1.6 amperes for each additional 941 unit. Some of the specifications of the CPC components are as follows:

Typebars and Speed

- 412: 88 typebars, 100 cards per minute when printing, 150 cards per minute when not printing.
 418: 89 typebars, 150 cards per minute at all times. (A lengthy iterative calculation in the 605 using program repeat, or punch operations in the 527, will reduce the operating speed of the CPC somewhat.)

412-418 Features

- 80 Counters, net balance.
 Digit selector: None standard; up to 4 optional.
 2-position pilot selector: 76 standard; more optional, depending on other features.
 5-position co-selector: 72 standard; more optional, depending on other features.
 10-position, 10-level field selector: 1 standard.
 Digit emitter: 1 standard.
 Coding selector: 10 standard.
 Panel switches: 2 standard; 7 more optional.
 2-position latch selectors: 5 standard.

605 Features

- Negative-balance selector: 1 standard; 3 more optional.
 Program levels: 60 standard.
 Program exits: 180 standard.
 Program repeat: standard.
 Group suppress: 4 standard.
 Zero test suppress: standard.
 Calculator selectors: 18 standard.
 Program repeat selectors: 10 standard.

527 Features

- Punch selectors: 8 standard; more optional.
 Pilot selectors: 5 standard; more optional.
 1/2 Time Emitter: standard.
 Punch Delay: standard.
 Calculator selectors: 18 standard.
 Double-Punch and Blank-column detection.

941 Features

- One unit standard: one or two additional units may be added.
 Each unit has storage for 16 numbers, each with 10 digits and sign.

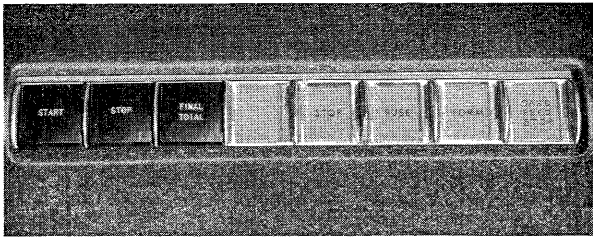

FIGURE 10. TYPE 412 OPERATING KEYS AND LIGHTS

412-418 OPERATING SWITCHES AND SIGNALS (Figure 10)

THE START-STOP controls and signals lights are operated in a manner similar to that described in the 402 and 604 instruction manuals. They are all listed here along with the added information needed for CPC operation. Each unit has its own operating keys and main power switches. The main line power switches of the component units must be turned on separately. When the 527 and 605 units are operating as part of the CPC, they are under control of the 412-418; their operating keys are normally not required.

Main Line Switch

To operate the CPC or the 412-418, the main line switch, located under the right end of the reading table, must be turned on.

Start Key

The start key must be depressed to start feeding cards through the machine. It must also be depressed to resume operation after the machine has stopped for any reason other than feed interlock.

Stop Key

When the stop key is depressed, the machine will stop before the next card is fed. If a program cycle is in process when the stop key is depressed, the cycle will be completed before the machine stops.

Final Total Key

This key provides for manual control over final total printing. When a counter is controlled from a final total hub on the control panel, that counter cannot be cleared until the following conditions are satisfied:

1. All cards must have entered the stacker.
2. The final total key must be depressed and held down while the start key is depressed.

Unlabeled Light

The unlabeled light will go on when the main line switch is turned on and the 412-418 is ready to run.

Stop Light

The red stop light will go on whenever the machine stops because of an impulse received by a machine stop hub or the test hub on the control panel. While the stop light is on, the machine cannot be restarted. To turn the stop light off, the final total key must be depressed.

Fuse Light

The red fuse light goes on and the machine stops whenever a fuse burns out.

Form Light

The red form light goes on and the machine stops whenever the last form is within 10 inches of the platen and the form control lever is in the ON position.

Card-Feed-Stop Light

The red card-feed-stop light goes on whenever a summary punch operation is started by the accounting machine. The light will remain on and further operation of the accounting machine will be prevented if for any reason the summary punch operation is not satisfactorily completed, or if there is no card at the punching station, or if no cards are in the 527 card feed hopper.

The following switches and buttons (Figure 11) are located on the left side of the machine.

Non-Print Run-Out Button

This button may be depressed if for any reason it is desired to run cards out of the machine without printing. It does not suppress other normal operations, such as counter read-in, and channel instructions.

Feed Interlock Start Button

The purpose of feed interlock is to stop the machine and prevent accidental total printing in the event of a card-feed failure, as shown in Figure 12. If a card fails to feed from the hopper to position A, the machine stops. At this point there are cards in the hopper, no card at position A, and a card at position B. The machine cannot be restarted except by

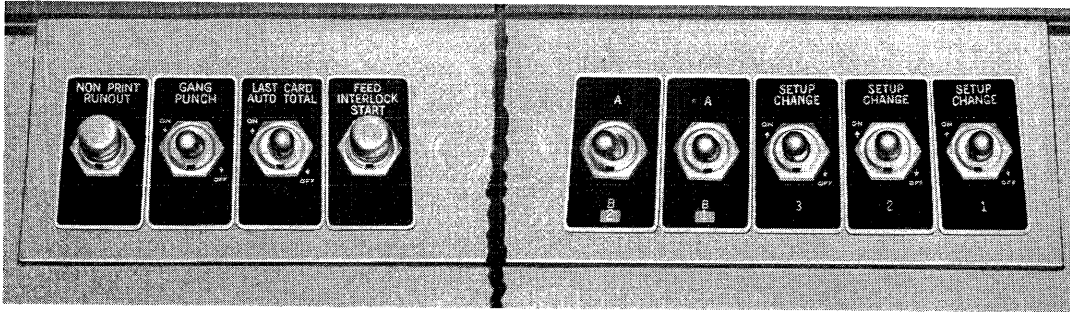

FIGURE 11. TYPE 412 SWITCHES AND BUTTONS

depressing the feed interlock start button, at which time card B runs out into the stacker. Card B performs all normal functions, except comparing, thus preventing a program change.

The card in the hopper that failed to feed must be corrected. Card B must then be placed in front of the card that failed to feed and the rest of the cards from the card feed hopper and inserted in the hopper. To restart the machine, the feed interlock start button must be depressed. On the run-in, card B does not add, subtract, calculate, or print, but only compares. The operation for succeeding cards will be normal.

If it is not desirable to continue the run, after a card-feed failure, it will be necessary to clear the feed interlock before a new run may be started. This is done by passing a card through the machine using the card feed interlock start button.

Last Card Auto Total Switch

The primary purpose of this switch is to provide a means of obtaining total program cycles on the run-out, thus permitting the clearing of counters without program control.

When the switch is on, the machine functions are as follows: All normal program controls are suspended and a major program change is forced on both the run-in and run-out, regardless of control-panel wiring. Detail printing will not be suspended for

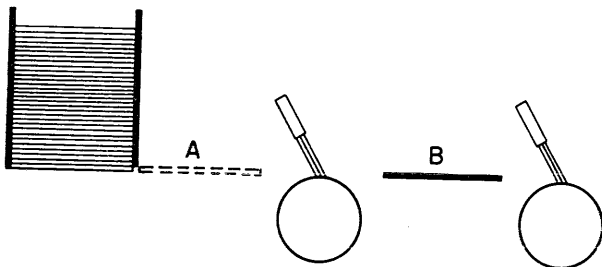

FIGURE 12. SCHEMATIC OF 412 FEED INTERLOCK

heading cards if the machine is set for group printing. Carriage skipping, if initiated by one of the cards being processed, will not be suspended.

When the switch is off, program control wiring will function in the normal manner. Whether the switch is on or off, only those counters will be cleared whose total hubs are wired to clear.

Setup-Change Switches 1, 2, 3

Within reasonable limitations one control panel may be used for several different problems without any change in control-panel wiring, by the use of the setup-change switches, located on the side of the machine. Each setup-change switch has a hub on the control panel which emits an impulse when the corresponding setup-change switch is turned on.

If the setup-change exits are wired to the pickups of co-selectors, the selectors can then be used to change machine functions according to the position of the setup-change switch.

Panel Switches

The toggle switches immediately to the left of the setup-change switches are associated with hubs on the control panel labeled Sw 1, A, C, B; Sw 2, A, C, B; etc. There is an electrical connection between the C hub and the corresponding A or B hub as the associated toggle switch is thrown to A or B. Two panel switches are standard; seven more are optional.

527 OPERATING SWITCHES AND SIGNALS

(Figure 13)

Main Line Switch

When the main line switch on the 527 is turned on, the power-on button on the 605 has been depressed, and the unlabeled green light is on, power is supplied to the 527. When the 527 unit is being used inde-

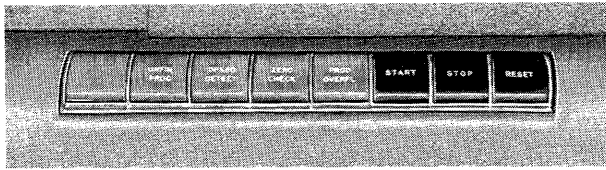

FIGURE 13. TYPE 527 CONTROLS AND LIGHTS

pendently, operation may be started as soon as the main-line switch is turned on.

In the CPC combination, the 527 functions as a summary punch. When no punching is desired, the 527 main-line switch still must be on but the summary-punch switch on the 412-418 panel may be unwired (OFF). In this case it is not necessary to run summary cards into the 527.

Start Key

This key is not used for control of normal CPC operations. It should be depressed three times to advance a card to the punch station (Figure 14); after this, all control is handled from the 412-418.

Stop Key

The stop key, when depressed, stops the operation of both the 527 and the 605. It is not used for CPC control.

Reset Key

When an error is signaled by one of the four lights located on the punch, the machine may not be restarted until the reset key is depressed.

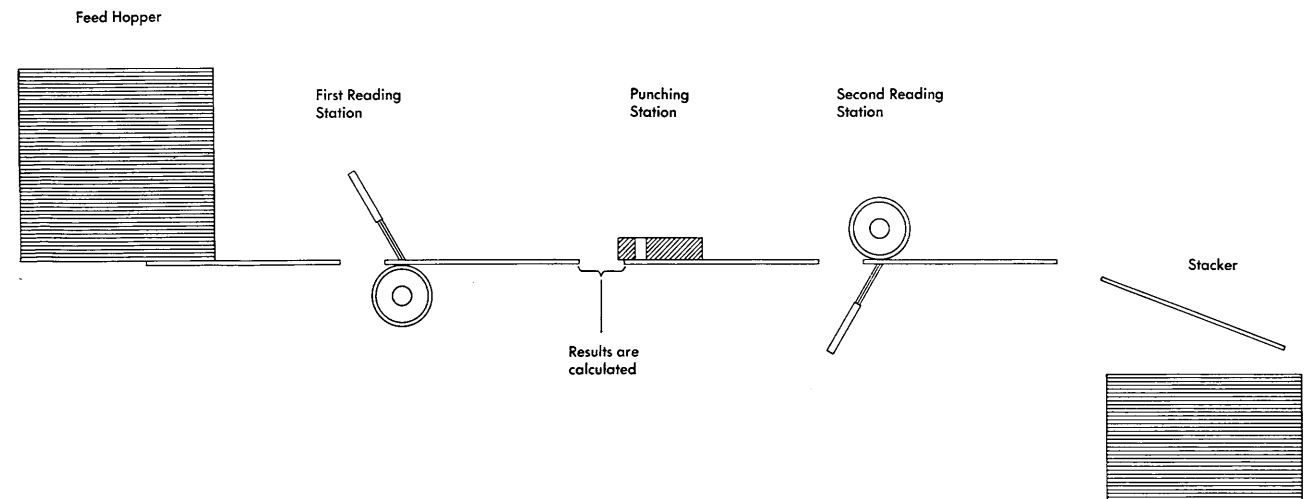

FIGURE 14. SCHEMATIC DIAGRAM OF 527 CARD STATIONS

Unlabeled Light

The unlabeled light turns on as soon as the machine is ready to operate. This light turns off as cards are passing through the machine and turns on again when the machine stops. It also turns off when the control panel in the 527 is removed.

Unfinished Program Light

There is no such thing as an unfinished program in CPC operation. The 412-418 cannot start until the 605 completes the calculation called for. In independent 605-527 operation, the red unfinished program light turns on, the machine stops, and all punching is suppressed in those rare instances when a calculation cannot be completed in the time that is required for the card to move from the first reading station to the punch station. This light is operated by control panel wiring.

Double-Punch Blank-Column Light

The red double-punch blank-column light turns on, and the machine stops, whenever a double punch or a blank column is sensed. This light is operated by control-panel wiring, and is normally used in conjunction with checking operations.

Zero-Check Light

The red zero-check light turns on if, in a testing operation, the punched result subtracted from the recalculated result does not equal zero. This light is operated by 605 control panel wiring.

Product Overflow Light

The red product overflow light turns on, and the machine stops, if the result of a calculation exceeds the number of card columns to be punched. This light is operated by 527 control-panel wiring.

605 OPERATING SWITCHES AND SIGNALS

(Figure 15)

Power-On Key

When this key is depressed, power is applied to all the electronic tubes.

Starting Light

This red light comes on when the power-on key is depressed. It remains on for about two minutes while the electronic tubes in the 605 are warming up; then it turns off.

Unlabeled Green Light

This green light turns on when the starting light goes off, about two minutes after the power-on key is depressed.

Control-Panel Light

This light comes on when the control panel is removed from the 605.

Power-Off Key

When this key is depressed, the 605 is turned off, and all lights go out.

Program Test Key

This key must not be depressed unless the 412-418 is at rest. Depressing this key makes it possible to operate the 605 one electronic cycle at a time. Depressing the key a second time returns the 605 to high-speed operation.

Program-Test Light

This light comes on when the program-test key has been depressed for the first time, and the program steps are under control of the program advance key.

Start Key

When the individual machine units are connected as a CPC, this start key controls the accounting machine card-feeding in the same manner as the start key on the 412-418 machine. This start key performs the same function as the Type 527 start key when the Type 527 and 605 are used as a separated machine combination.

Stop Key

The stop key, when depressed, stops the operation

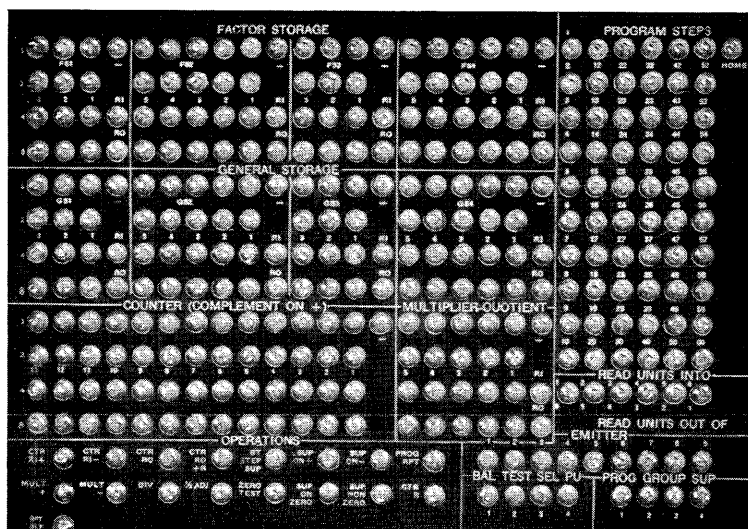

FIGURE 15. TYPE 605 CONTROLS AND LIGHTS STATIONS

of all the CPC units. The machine stops at the end of the cycle in which the key was depressed.

Indicator Lamp Panel

The neon lamps in this panel indicate the numbers stored in any of the numerical units of the 605. The numbers are represented in the binary-coded decimal notation (i. e., the number is represented in the decimal system but each digit is expressed in the binary system). A positive number in the 605 counter appears on the panel as a nines complement.

Program Advance Key

When the program test key has been depressed and the program test light is on, the program steps may be advanced by depressing this key.

When the 605 program steps are under the control of the program advance key, the neon lamps indicate the program step which has just been completed and the functions which were used on that program step.

A single depression of this key will cause the calculator to take one electronic cycle. Program steps that are wired for crossfooting advance one step with each key depression. A multiply or divide program step requires one key depression for each cycle of multiply or divide, and the calculator will stay in that program step until the multiplication or division is completed. Depressing the key and holding it down will cause the calculator to take that cycle immediately and after a short pause will proceed through the succeeding program steps at slow speed. Upon release of the program advance key, the calculator will stop at the end of that cycle. Thus, by holding the key depressed the operator can quickly cause the calculator to proceed to a specific program step, and stop.

CONTROL PANEL

CONTROL PANELS are on the Types 412-418, 605, and 527. The accounting-machine control panel is the

master control unit. Its wiring determines the card fields to be read for input information, the calculator operations to be performed, the printing of results, and also contains the entry and exit hubs for the storage units of the Type 941 unit and the calculator. Thus, all normal 402 operations plus CPC control are wired on this panel.





The Type 605 panel is wired to program the crossfooting and calculations that occur during calculate time.

The Type 527 panel is wired as a summary punch when it is used with the CPC. If the 527 and 605 machines are used independently, the 527 panel serves as the master control panel for input and output factors.

Type 412-418 Control Panel



The control panel features are separated into four classifications (Figure 16). This was done to illustrate the many features with which the reader is already familiar from past experience in using the Type 402 accounting machine and Type 604 calculating punch. It also highlights the CPC features that will be discussed in this manual.

The 4 classifications shown are:

- | | |
|---|--|
|  | 1. Pilot selectors, co-selectors, and bus hubs. |
|  | 2. Standard Type 402 features. |
|  | 3. Standard Type 604 hubs that are available on this panel. |
|  | 4. Features for CPC control and Type 941 read-in and read-out. |

Calculator Control Panel

This control panel (Figure 17) is shaded to show three classifications of control-panel hubs.

- | | |
|---|--|
|  | 1. Standard 604 features. |
|  | 2. Standard 604 features that have been modified to make them more flexible or to increase machine capacity. |
|  | 3. New features that were not on the Type 604 machine. |

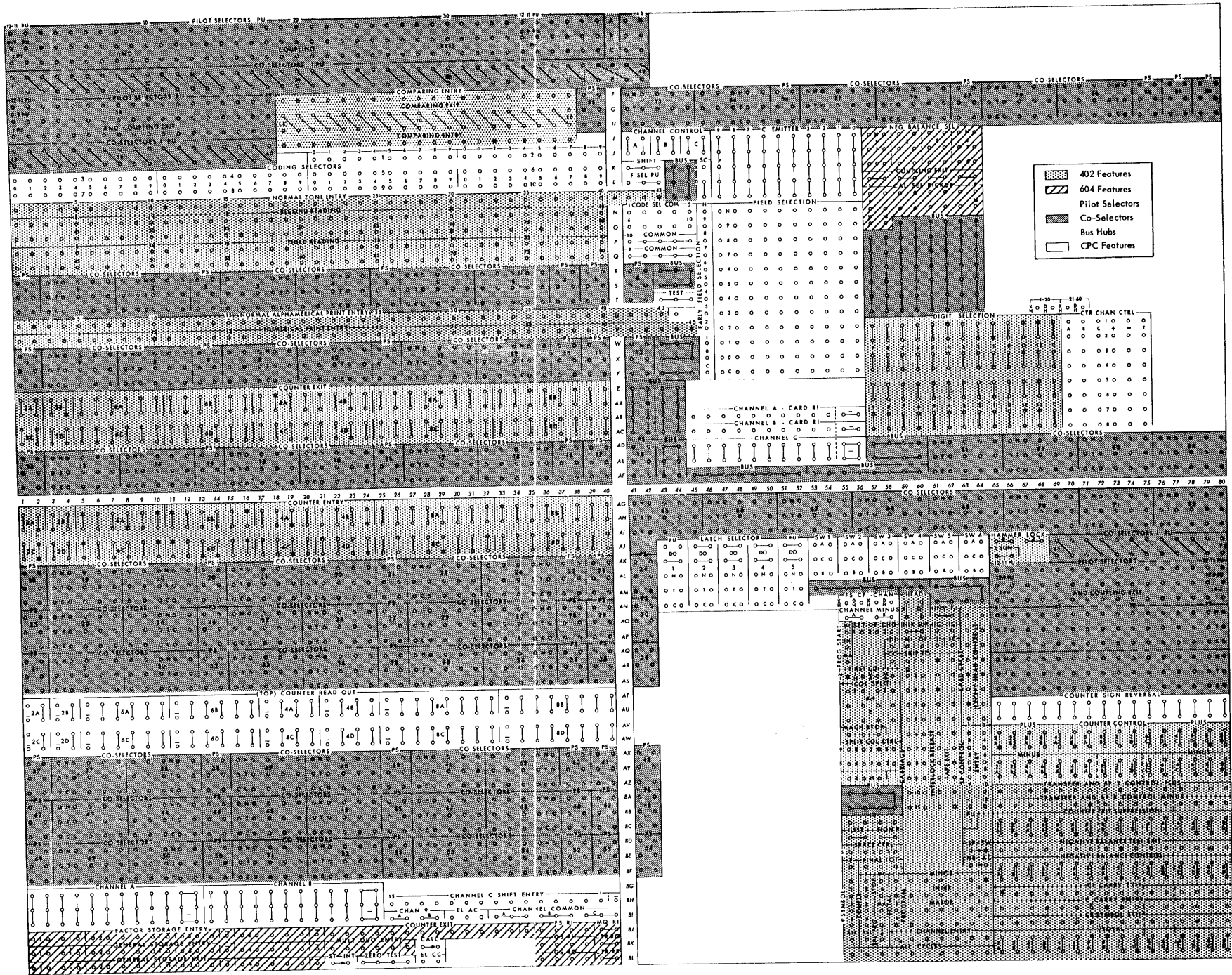

FIGURE 16. TYPE 412 CONTROL PANEL

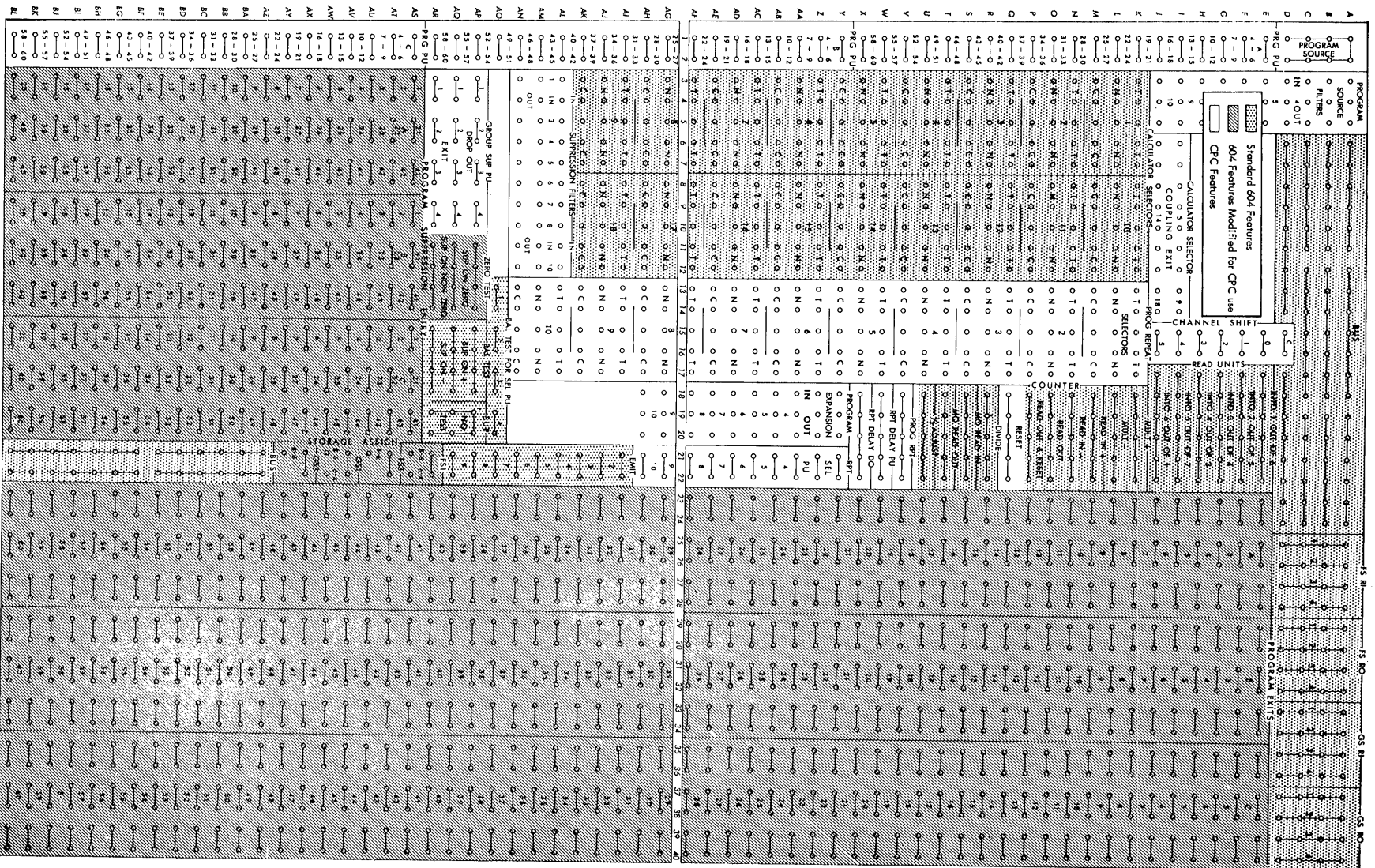

FIGURE 17. TYPE 605 CONTROL PANEL

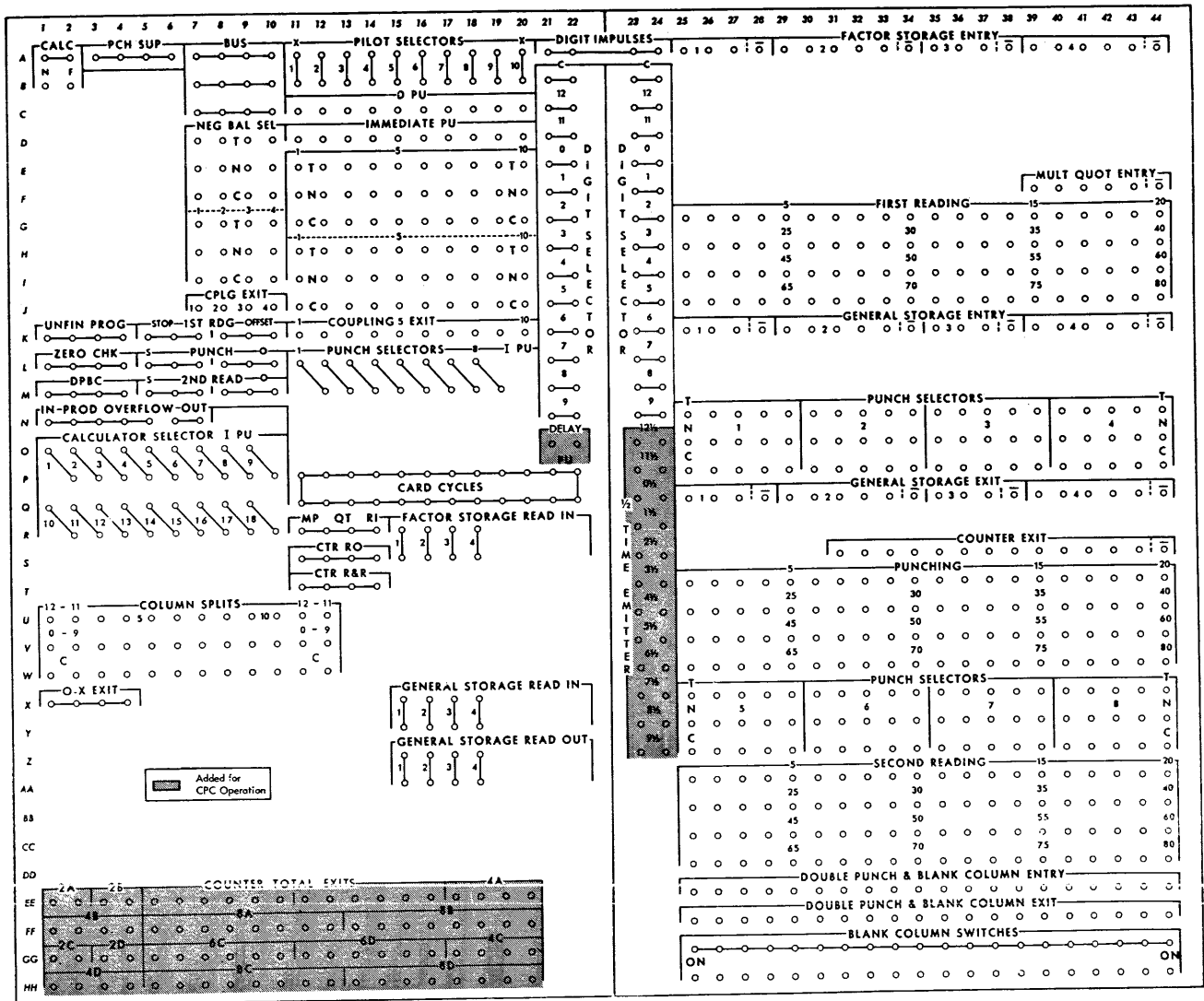



FIGURE 18. TYPE 527 CONTROL PANEL

Punch Control Panel (Figure 18)

This panel has only one shaded area. This gives two classifications:

-  1. Unshaded areas show standard 604 control panel hubs.
-  2. Features added to adapt the punch for CPC operation.

STANDARD CPC CONTROL PANEL FEATURES

THE SHADED areas in Figures 19 and 20 indicate possible increased-capacity features that are available on the 412 and 527 machines. All unshaded features are standard on the Model A1 CPC. The 605 control panel features are all standard except for negative balance selectors 2, 3, and 4.

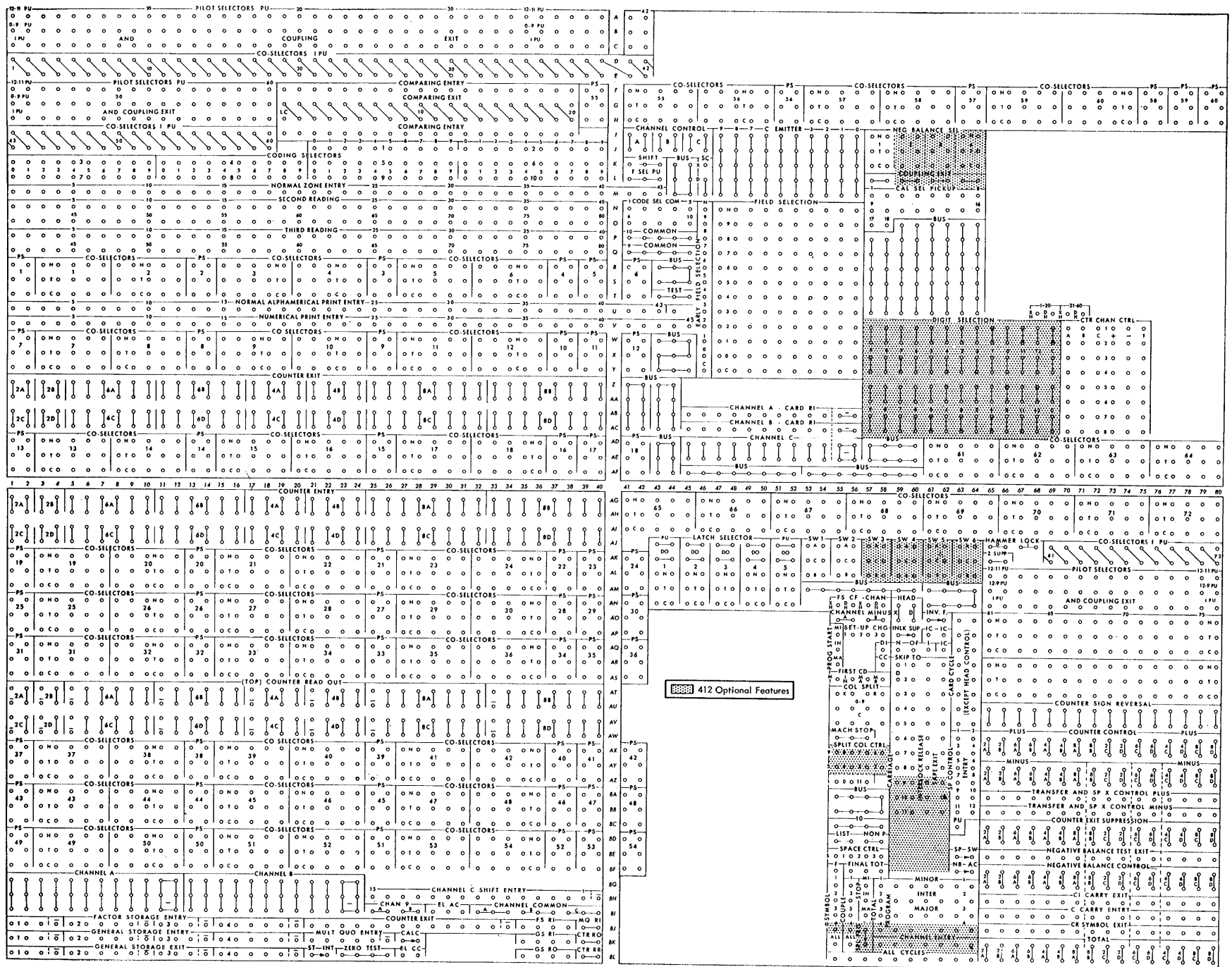

FIGURE 19. TYPE 412 STANDARD AND OPTIONAL FEATURES

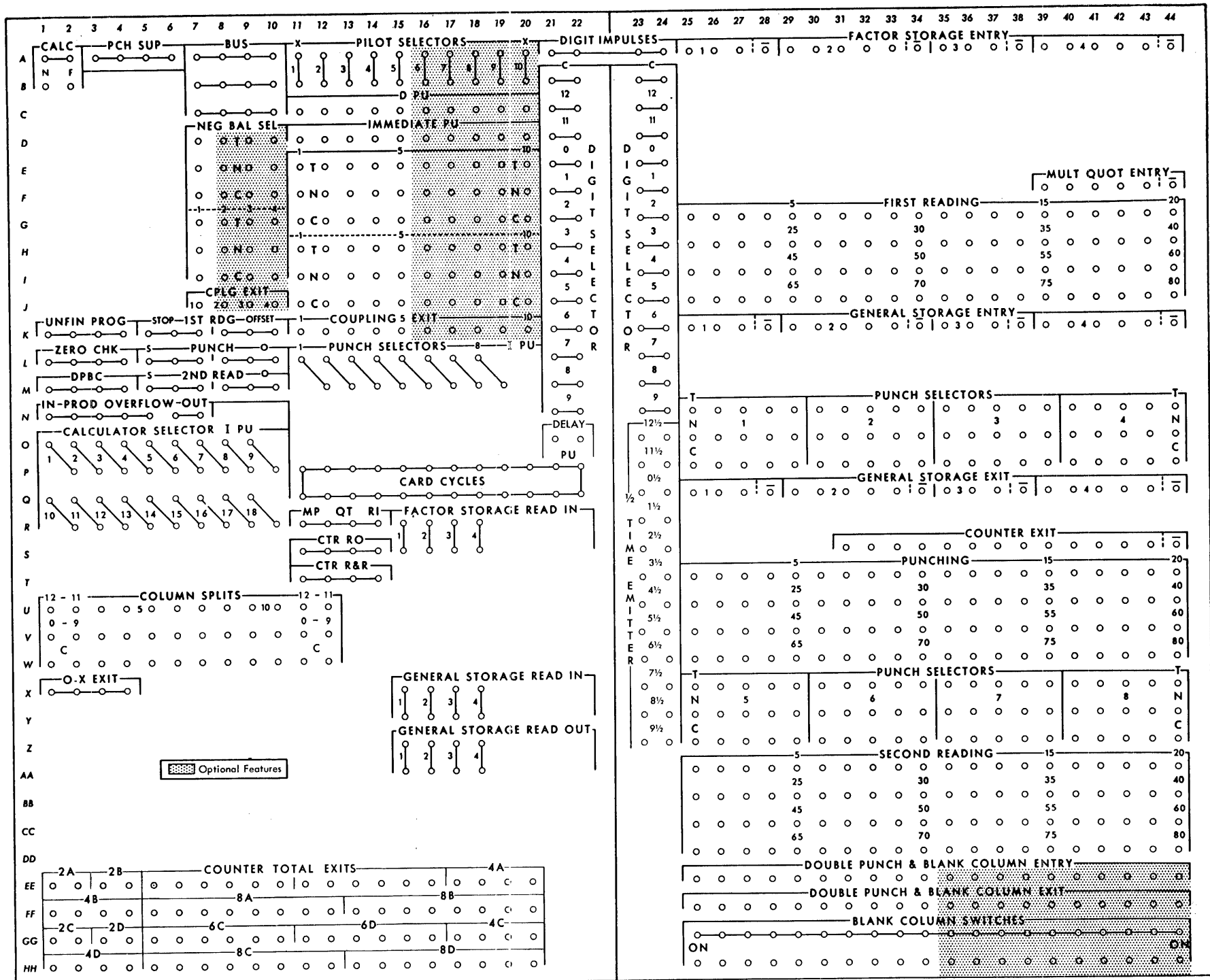

FIGURE 20. TYPE 527 STANDARD AND OPTIONAL FEATURES

PRINCIPLES OF CONTROL PANEL WIRING

READ-IN—CALCULATE—PRINT

$$A \times B = P \quad \text{Rate} \times \text{hours} = \text{Regular Amount}$$

THIS APPLICATION illustrates a basic way of using the three units of the CPC. The 941 storage unit is not used in this application.

1. Read-in factors from IBM cards.
2. Calculate a result.
3. Record the result in printed form.

A schematic of this basic concept is shown in Figure 21. Many applications are merely an enlargement of this basic concept, except that more factors are handled, or more calculating operations are performed.

The wiring of the Type 412 control panel is similar to Type 402 control-panel wiring. The Type 605 wiring is comparable to Type 604 wiring except for the program exit arrangement, which is briefly explained in this application.

Thus, the CPC is an accounting-calculating machine and the Type 412 serves as a card-input, print-output unit.

Accounting Machine Control Panel

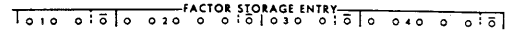

BJ, 1-20

Factor Storage Entry. These hubs are entire to the factor storage units of the Type 605 from the accounting machine. They are normally wired from SECOND or THIRD READING, 412 COUNTER EXITS or CHANNEL A and B (Type 941 exits). All sign-control impulses must be wired to the sign hub. The units position does not recognize sign control impulses; it only accepts the digit value to be stored in that position.

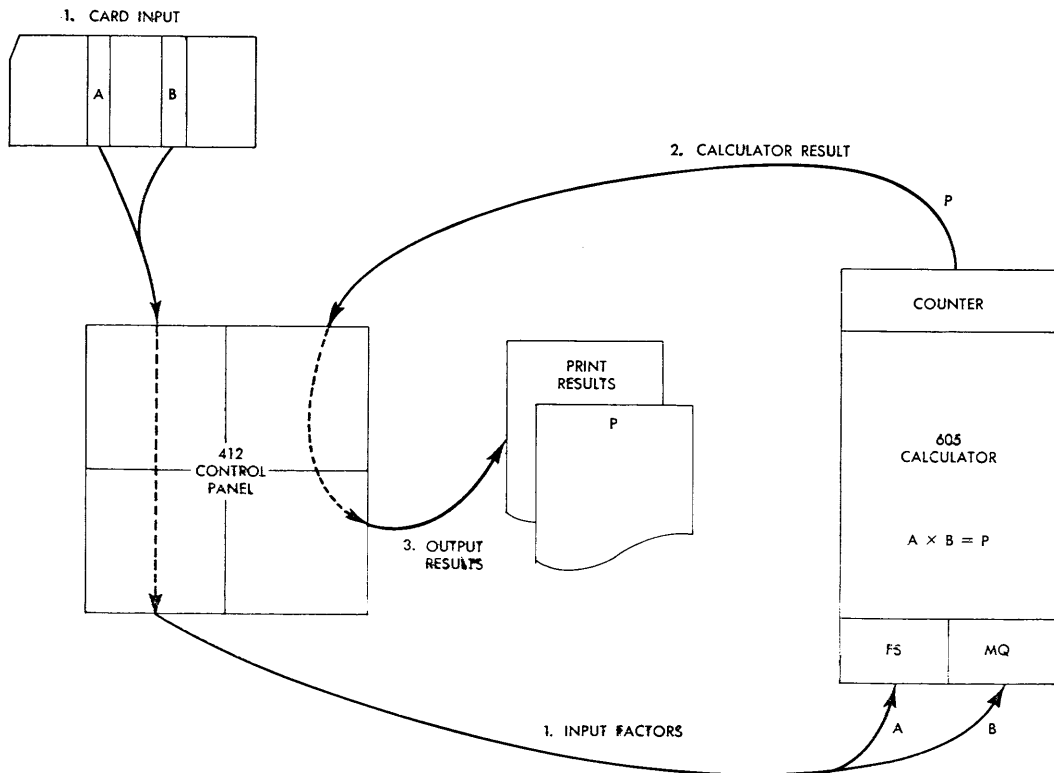
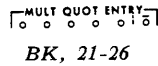
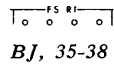

FIGURE 21. READ-IN—CALCULATE—PRINT SCHEMATIC



Multiplier-Quotient Entry. These hubs are entries to the MULT-QUO storage unit of the Type 605 from the accounting machine. Wiring to these hubs is similar to factor storage entry wiring.



Factor Storage Read-in. Each factor storage unit has a read-in hub that accepts only a 10-impulse, which clears out the previous amount by resetting the storage unit to zero.

FS RI is normally wired from 10 COMMON, ELAC, ELCC, or CHANNEL A or B COMMON, if channel control is being used.

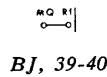

Multi-Quo RI. These are the read-in control hubs for entering information into the MQ unit. Their function and wiring are similar to factor storage read-in hubs.

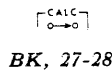

Calculate Switch. The calculate switch is wired whenever the accounting machine and calculator are used together.

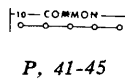

10 Common. These hubs emit a 10-impulse on all machine cycles. They are normally wired to FS-RI, GS-RI or MQ-RI.

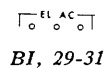

Electronic All Cycles. These hubs emit an impulse on all machine cycles. The impulse is of longer duration than the ALL CYCLES impulse. It is normally wired to GS RO, CTR RO, or CRT RR.

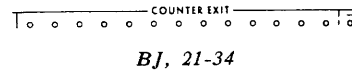

Counter Exit. These hubs serve as exits, from the electronic counter, of results obtained during calculate time. These exits may be wired to PRINT ENTRY to print the results, or to CHANNEL C to store the results in the Type 941 storage registers. Sign control impulses for negative numbers read out of the electronic counter are available only at the SIGN EXIT hub (BJ, 34).



Counter Read-out and Reset. An impulse to these hubs causes the Type 605 counter exits to read-out the value in the counter. CTR RR can be wired *only* from ELECTRIC ALL CYCLES, ELECTRONIC CARD CYCLES, or CHANNEL C COMMON. The ALL CYCLES and CARD CYCLES hubs that are used with standard Type 402 features cannot be wired to CTR RR or to CTR RO.

Calculator Control Panel

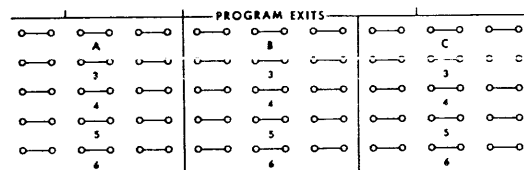

E-BL, 23-40

Program Exits. The Type 605 calculator is a 60-program machine. Each program step has three sets of exit hubs; A exits, B exits, C exits. Thus, 180 instructions may be wired in the program unit. Any 60 of these instructions can be used on one program sweep, or all 180 instructions may be placed in series if the program repeat and repeat delay features are used. This stored program capacity of 180 instructions allows very flexible program arrangements to be wired and called for to suit the application.

Program exits are not active unless their respective program pickup (PRG-PU) hubs are impulsed. The program pickup hubs are wired from PROGRAM SOURCE.

Program exits are wired to calculator function hubs

in the same manner as the Type 604 program exits are wired. The double hub for each program exit permits wiring many program steps to a single function without using split wires. This is called *chain* wiring. The double hub for each program exit must be wired to only one function. If more than three program exits are needed on a given program step, the program expansion units must be used.

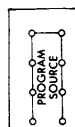

A-D, 1-2

Program Source. The PROGRAM SOURCE hubs are exits that are wired to activate PRG. PU. The program source wiring may be wired through the calculator selectors, or repeat selectors, to vary the program exit pattern. The PROGRAM SOURCE hubs are not electronic exits. They must not be wired to calculator functions.

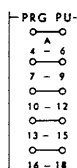

E-BL, 1-2

Program Pickup (PRG. PU). When a program pickup is impulsed, it makes the program exits for three program steps active. There are three sets of program pickup hubs: A, B, and C. They correspond to the three sets of program exits: A, B, and C. Thus, if program pickup A 1-3 is impulsed, the A PROGRAM EXITS for program steps 1, 2, 3, are active. If program pickup B 4-6 is impulsed, the B PROGRAM EXITS for program steps 4, 5, 6 are active, etc.

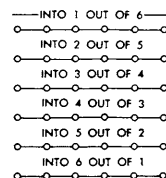

E-J, 17-22

Shift Unit. These hubs accept program exit impulses to shift a number that is transferring between storage units or between the counter and storage units in the 605. The shift unit is identical to the Type 604 shift unit except that corresponding read-units-into and read-units-out-of hubs have been combined. When wiring a transfer from storage to counter or storage to storage, use the INTO portion of the shift unit title. When wiring a transfer from counter to storage, use the OUT OF portion of the title.

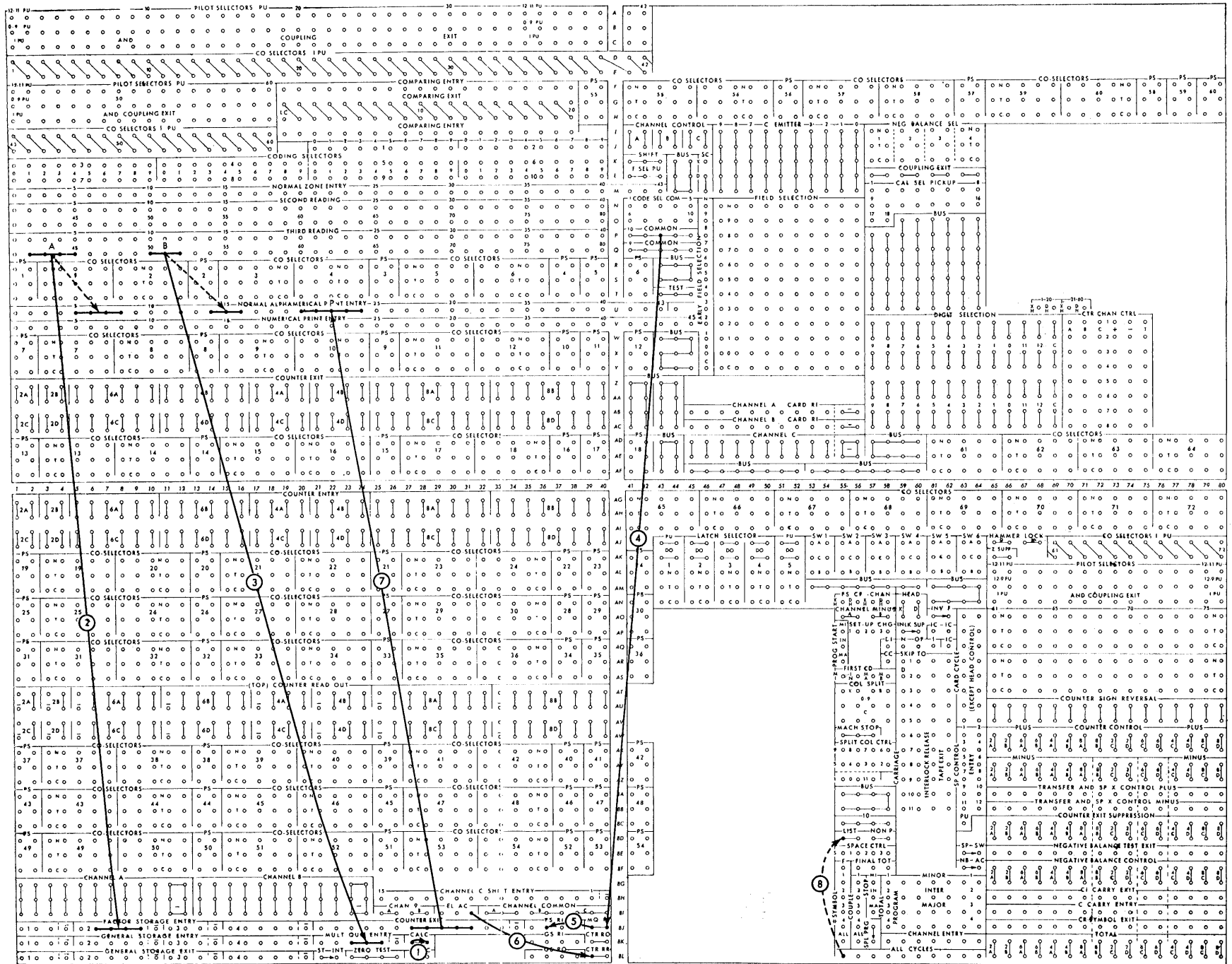

FIGURE 22. $A \times B = P$

Wiring for Read-in (Figure 22)

1. CALC SWITCH is jackplugged. This interlocks the Type 412 and Type 605 machines.
2. Columns 42-45, THIRD READING, enter rate into FACTOR STORAGE 2. The dotted wiring from THIRD READING to NORMAL ALPHAMERICAL PRINT ENTRY is standard 402 wiring for detail printing.
3. Columns 50-52, THIRD READING, enter hours into MULT-QUO ENTRY.
- 4 and 5. The TEN COMMON emits a 10-impulse to cause FACTOR STORAGE 2 and MULT-QUO UNIT to reset.

5. Because the product contains 4 decimal places, the INTO 2 OUT OF 5 is wired to place the 1/2 adjust in the tens position of the counter.

When the calculator completes program step 3, it will take program steps 4, 5, 6, 7—to 60; however, because none of these program exits are active, the result will remain in the electronic counter until the accounting machine calls for read-out to print.

Wiring for Calculation of $A \times B = P$ (Figure 23)

1. Wiring from PROGRAM SOURCE to PROGRAM PICKUP A 1-3 makes the A exits of program steps 1, 2, 3 active.
2. PROGRAM EXIT A 1 to FS2 RO reads the multiplicand out of FS2.
3. PROGRAM EXIT A 1 to MULTIPLY.
4. The product is 1/2 adjusted by the wiring of program step 2.

Wiring for Print (Figure 22)

6. ELECTRONIC ALL CYCLES is wired to COUNTER READ-OUT and RESET to cause the Type 605 counter to read out its value, and then reset to a zero value before the next calculate time.
7. The Type 605 COUNTER EXIT positions are wired to print the product (P) in ALPHAMERICAL PRINT ENTRY 20-24.
8. The ALL CYCLES to LIST dotted wiring is standard Type 402 wiring for detail printing.

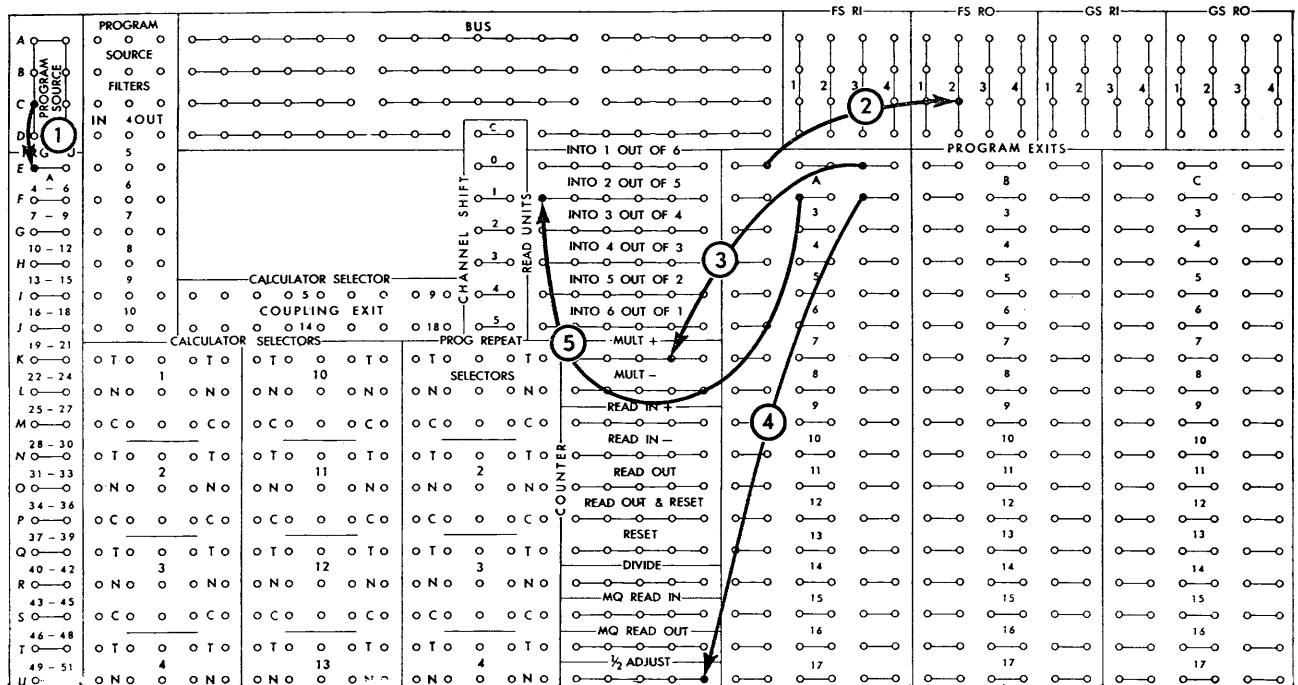

FIGURE 23. $A \times B = P$

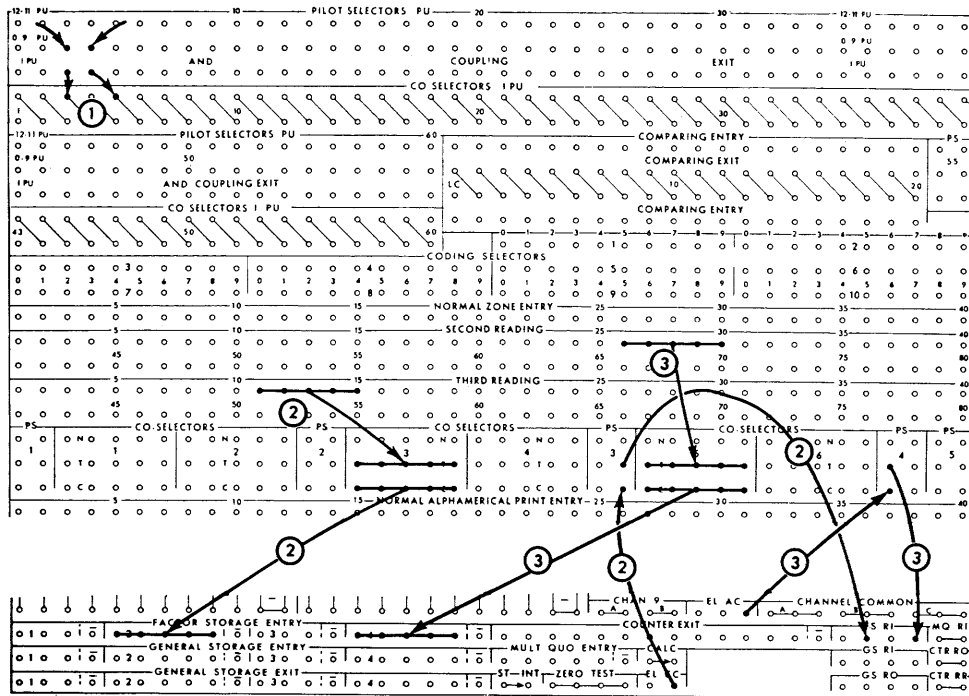
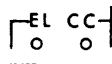

FIGURE 24. SELECTIVE READ-IN TO THE CALCULATOR

SELECTIVE READ-IN TO THE CALCULATOR

AMOUNTS READ from card fields into calculator storage entry may require selection. Figure 24 shows two card fields being selected, one from third reading, the other from second reading. Selection of the field *and* the FS RI hubs is necessary when read-in is to occur only for specified cards. The FACTOR STORAGE ENTRY hubs accept digit impulses on any machine cycle regardless of the FS RI wiring. The FS RI hub accepts an impulse to cause reset of its respective storage unit; it does not control entry into the individual positions.



BL, 27-28

Two independent ELECTRONIC CARD CYCLES hubs are provided. They emit, on card cycles only, an impulse similar to an ELAC impulse. They are commonly

wired to GS RO, CTR RO, or CTR RR. They may also be wired to FS and GS RI.

Wiring (Figure 24)

1. The pilot selector pickup wiring is not shown. It will vary with the application and be similar to 402 selector wiring. Pilot selector 4 pickup would be impulsed by the previous card, or the previous machine cycle, as it controls a second reading station field.
2. EL CC emits and is wired through PILOT 3 transferred to FS2 RI hub. This resets FACTOR STORAGE 2. Columns 11-15 from THIRD READING are wired through transferred CO-SELECTOR 3 to FACTOR STORAGE 2 ENTRY.
3. ELECTRONIC ALL CYCLES causes fs4 to reset when PILOT SELECTOR 4 is transferred. SECOND READING is wired to FACTOR STORAGE 4 ENTRY through transferred CO-SELECTOR 5.

BASIC ARITHMETICAL OPERATIONS

Multiply	$A \times B = P$
Add	$A + B = S$
Subtract	$A - B = T$
Divide	$A \div B = Q$

Every CPC application uses one or more of these basic operations. They are wired on the calculator control panel and controlled through calculator selectors. Thus the calculator operation to be performed is selected by pickup of calculator selectors from an operation code field or X-punches in the card.

The operation codes selected for this application show both the X and digit code type of pickup for calculator selectors.

OPERATION CODE	CALCULATOR OPERATION
X76	Multiply
X78	Divide
Digit 1 Column 80	Add
Digit 2 Column 80	Subtract

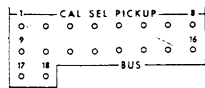

M-N, 57-64; O, 57-58

Calculator Selector Pickup

Each of the 18 calculator selectors has a pickup on both the Types 412 and Type 527 control panels. The selector hubs are on the Type 605 control panel and are used to select calculator functions.

The pickup on the Type 412 control panel will accept digits 9 through 0 wired from THIRD READING BRUSHES to transfer the selector for calculate time of that card. If an X- or 12-punch in the card is used, it must be wired from SECOND READING to PILOT SELECTOR PU. The calculator selector pickup can then be wired from a digit impulse through the transferred PILOT SELECTOR. The CALCULATOR SELECTOR pickup is an immediate pickup that transfers the selector immediately. The selector remains transferred until the end of calculate time.

Coding Selectors

Ten coding selectors are standard on the machine. The coding selectors are like digit selectors except that coding selectors operate on all active machine cycles

while digit selectors operate on card cycles only. Each coding selector has an inlet hub labeled CODING SELECTOR COMMON and ten exit hubs labeled with digits 0 through 9.

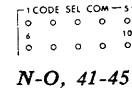

N-O, 41-45



J, 21-40; K-L, 1-40

The normal use of a coding selector consists of wiring from a card column that contains a code to the coding selector common hub. Any digit impulse punched in that column of the card is available at the appropriate one of the ten exit hubs and is used to pick up calculator selectors, pilot, and co-selectors. These selectors are then used to cause the machine to carry out the operation associated with that particular code. It should be noted that a code in the card can, under some conditions, consist of double punching in one or more columns. In this case the coding selectors will separate the double punches.

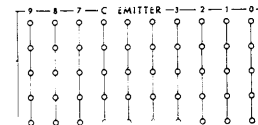

I-M, 47-56

Continuous Emitter

These hubs emit digit impulses on all active machine cycles. For example a digit 9 impulse is emitted from the 9-hub, a digit 8 from the 8-hub, etc. There are 5 common hubs for each digit impulse.

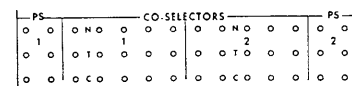
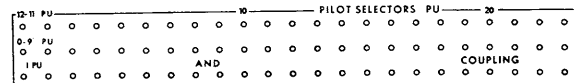

Pilot Selectors

There are 76 pilot selectors on the 412-418. The pilot selectors are of two types, differing in the manner in which they may be picked up. Pilot selectors 61 to 76 are similar to those on the standard Type 402-417. Pilot selectors 1 to 60 differ from selectors 61-76 in that their digit pickups will respond to 9-through 0-impulses, but will not respond to 11- or

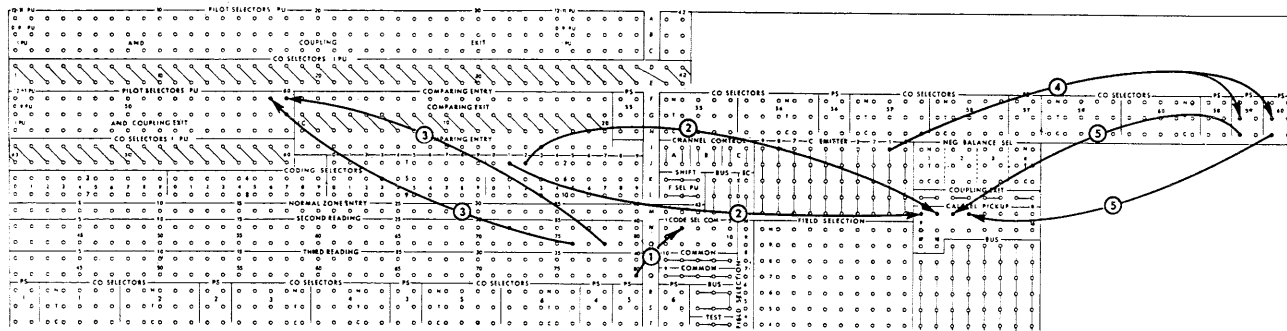

FIGURE 25. TYPE 412 CONTROL PANEL FOR BASIC OPERATIONS

12-impulses. This distinction between the two types of pilot selectors is indicated by the labeling of the pickup hubs on the control panel. The pickup hubs for pilot selectors 1 to 60 are located at A-C, 1-42; F-H, 1-18. Those for pilot selectors 61-76 are located at AL-AN, 65-80. The immediate pickup and coupling exits for all pilot selectors (1 to 76) function exactly the same as the Type 402 coupling exits.

Each pilot selector has two sets of common, normal, and transferred (C, N, and T) hubs. It should be observed that the relative locations of the N and T hubs have been interchanged on the 412-418 control panel. The hubs for pilot selectors 1 to 60 are found near the hubs of the correspondingly numbered co-selectors (1 to 60). The hubs for pilot selectors 61-76 are at AL-AT, 65-80. Information regarding the time of pickup and transfer of pilot selectors will be found on the timing chart and in the section of the manual devoted to selectors.

Wiring (Figure 25)

1. Operation code in column 80 of THIRD READING is wired to the CODING SELECTOR 2 COMMON. A 1-punch calls for a multiply operation; a 2-punch calls for a divide operation.
2. The 1 from CODING SELECTOR TWO is wired to pickup of CALCULATOR SELECTOR 1. The 2 impulse from column 80 comes out the 2-hub of the CODING SELECTOR to pickup CALCULATOR SELECTOR 2.
3. An X in column 76 of SECOND READING is wired to PILOT SELECTOR 59 PU. PILOT SELECTOR 60 is picked up from an X in column 78 of SECOND READING.

4. A 1 digit from the C Emitter to the transferred hub of PILOT SELECTOR 59 and 60 provides an impulse to pickup CALCULATOR SELECTORS for the card at the third reading station. Any digit impulse 9 through 0 can be used in this same manner.
5. CALCULATOR SELECTOR 3 PICKUP is wired from PILOT SELECTOR 59 COMMON. CALCULATOR SELECTOR 4 PICKUP is wired from PILOT SELECTOR 60. CALCULATOR SELECTOR 3 is wired on the Type 605 control panel to cause adding of two factors. CALCULATOR SELECTOR 4 is wired to perform subtraction.

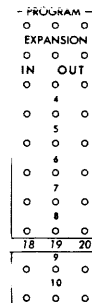

Calculator Control Panel Y-AH, 18-20

Program Expansion

Ten PROGRAM EXPANSION units are standard. Each has an IN hub and two OUT hubs.

They are used to increase the number of program exits for a program step, which prevents overloading program exit hubs. They are also used to start a function chain of two functions without causing a back circuit.

In this application, program expansion 1 is used to start a function chain for a divide-reset operation. The next program step requiring divide-reset would

IBM PLANNING CHART - CPC MODEL A1; CALCULATING UNIT - TYPE 605										OPERATION: MULTIPLY $A \times B = P$											
PROGRAM EXIT	PROGRAM PICKUP			PROGRAM SUPPRESSION			READ UNITS	OPERATION NOTES	FACTOR STORAGE ASSIGNMENT				MULTI QUOT	COUNTER	GENERAL STORAGE ASSIGNMENT				PROGRAM EXIT		
	CONDITIONS			CONDITIONS			INTO OUT OF		1	2	3	4			1	2	3	4			
	1ST	2ND	3RD	1ST	2ND	3RD			1	2	3	4			1	2	3	4			
								ELECTRONIC STORAGE													
								READIN													
1	CAL-SEL							MULTIPLY													
2								$\frac{1}{2}$ ADJUST													

FIGURE 26. $A \times B = P$ PLANNING CHART

then be wired to the double hub of program step 11 that started the chain, etc.

When any program exit is wired to an IN hub, two similar program exits are available at the corresponding OUT hubs. The two exits at the OUT hubs are electrically independent of each other.

Program expansion units are electronic units. For this reason, the program expansion hubs may be used only in control panel wiring where it is permissible to use program exits (see *Operating Suggestions*).

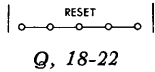

The RESET hub is wired from a PROGRAM EXIT to cause the counter to reset without reading out. It may be wired on the same program step as the divide function. In this case, reset of the counter will be delayed until dividing is completed.

Multiplication

$A \times B = P$ Rate \times hours = Gross earnings

The calculator will multiply on 8-place multiplicand by a 5-place multiplier and produce a 13-place product. Multiplication of larger-place factors can be handled by expanded multiplication, illustrated in the Type 604 manual. Because the multiply wiring was discussed in the previous application, it is shown as dotted lines in Figure 28. Multiplication is controlled by calculator selector 1. Figure 26 is the planning chart for $A \times B = P$.

Addition

$A + B = S$ Regular earnings + Piece work amount = Gross earnings

Addition on the Type 605 is wired in the same manner as on the Type 604. Program exits are wired to cause factor storage units to RO and the counter to RI+. These program exits are active only if their program pickup hubs are impulsed. The planning chart is shown in Figure 27.

IBM PLANNING CHART - CPC MODEL A1; CALCULATING UNIT - TYPE 605										OPERATION: ADDITION $A + B = S$											
PROGRAM EXIT	PROGRAM PICKUP			PROGRAM SUPPRESSION			READ UNITS	OPERATION NOTES	FACTOR STORAGE ASSIGNMENT				MULTI QUOT	COUNTER	GENERAL STORAGE ASSIGNMENT				PROGRAM EXIT		
	CONDITIONS			CONDITIONS			INTO OUT OF		1	2	3	4			1	2	3	4			
	1ST	2ND	3RD	1ST	2ND	3RD			1	2	3	4			1	2	3	4			
								ELECTRONIC STORAGE													
								READIN													
4	CAL-SEL																				
5																					
6																					

FIGURE 27. $A + B = S$ PLANNING CHART

WIRING (FIGURE 28)

1. PROGRAM SOURCE is wired through the transferred side of CALCULATOR SELECTOR 2 to PROGRAM PICKUP B 4-6.
2. PROGRAM EXIT B is wired to FS2 RO.
3. COUNTER R1+ is wired from PROGRAM EXITS B 4 and 5.
4. PROGRAM EXIT B 5 is wired to FS4 RO.

Subtraction

$A - B = T$ Gross earnings - Piece work adjustment = Base earnings
 Subtraction is performed by a storage read-out and

a counter read-in minus operation. A crossfooting operation of $A - B = T$ requires two program steps. The first step reads factor A into the counter +. The second step is the read-out of B to subtract from A and obtain the difference T.

WIRING (FIGURE 29)

1. PROGRAM SOURCE is wired through the transferred side of CALCULATOR SELECTOR 4 to PROGRAM PICKUP C 7-9.
2. PROGRAM EXIT C 7 causes FS2 RO and COUNTER RI+.
3. PROGRAM EXIT C 8 causes FS4 RO and COUNTER RI-.

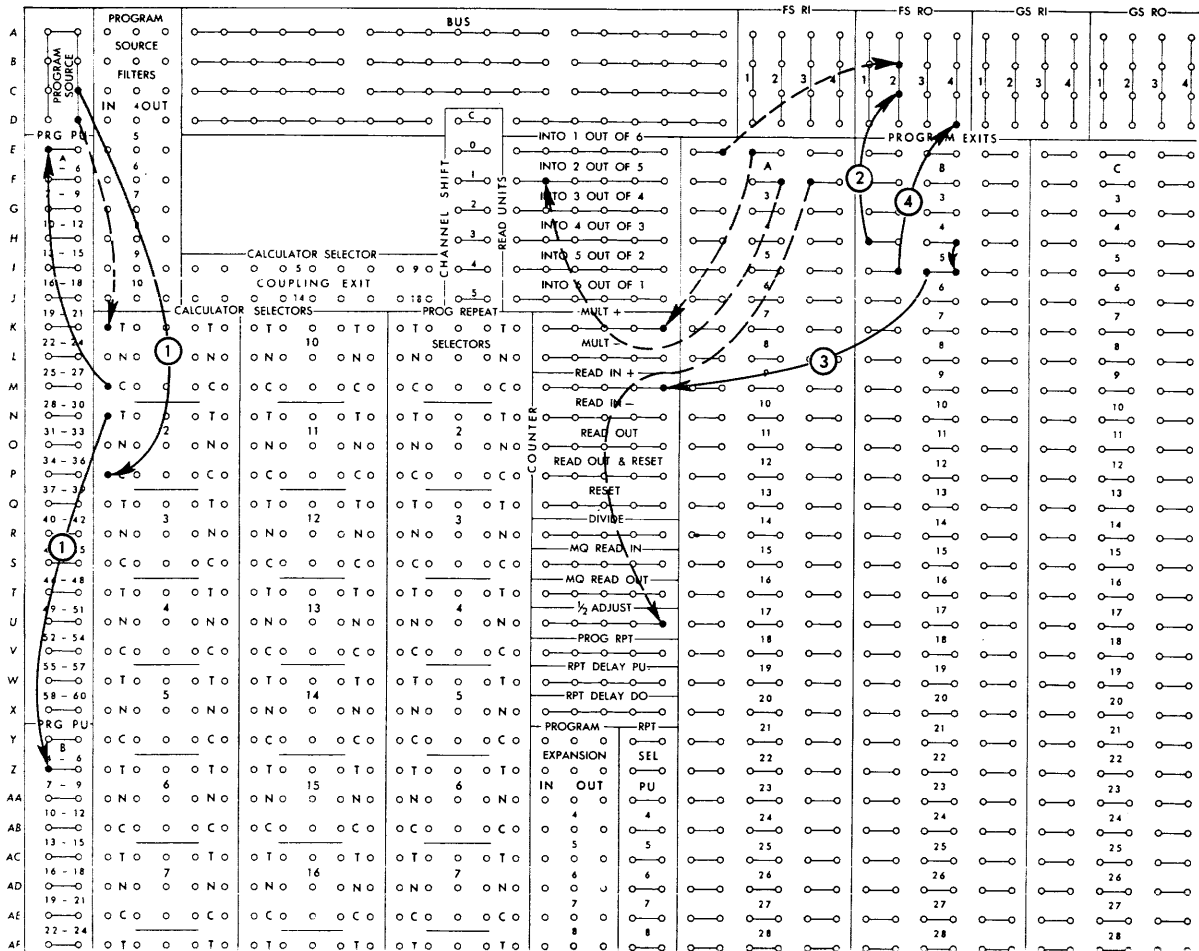

FIGURE 28. WIRING FOR $A + B$ AND $A \times B$

PROGRAM LEVEL	PROGRAM PICKUP			PROGRAM SUPPRESSION			READ UNITS	OPERATION NOTES	FACTOR STORAGE ASSIGNMENT				MULT. QUOT.	COUNTER	GENERAL STORAGE ASSIGNMENT			
	1ST	2ND	3RD	1ST	2ND	3RD			1	2	3	4			1	2	3	4
	CONDITIONS			CONDITIONS			INTO	ELECTRONIC STORAGE										
7			CAL SEL 3				INTO	READIN	A	B			RT +					
8							OUT						RI -					
9																		

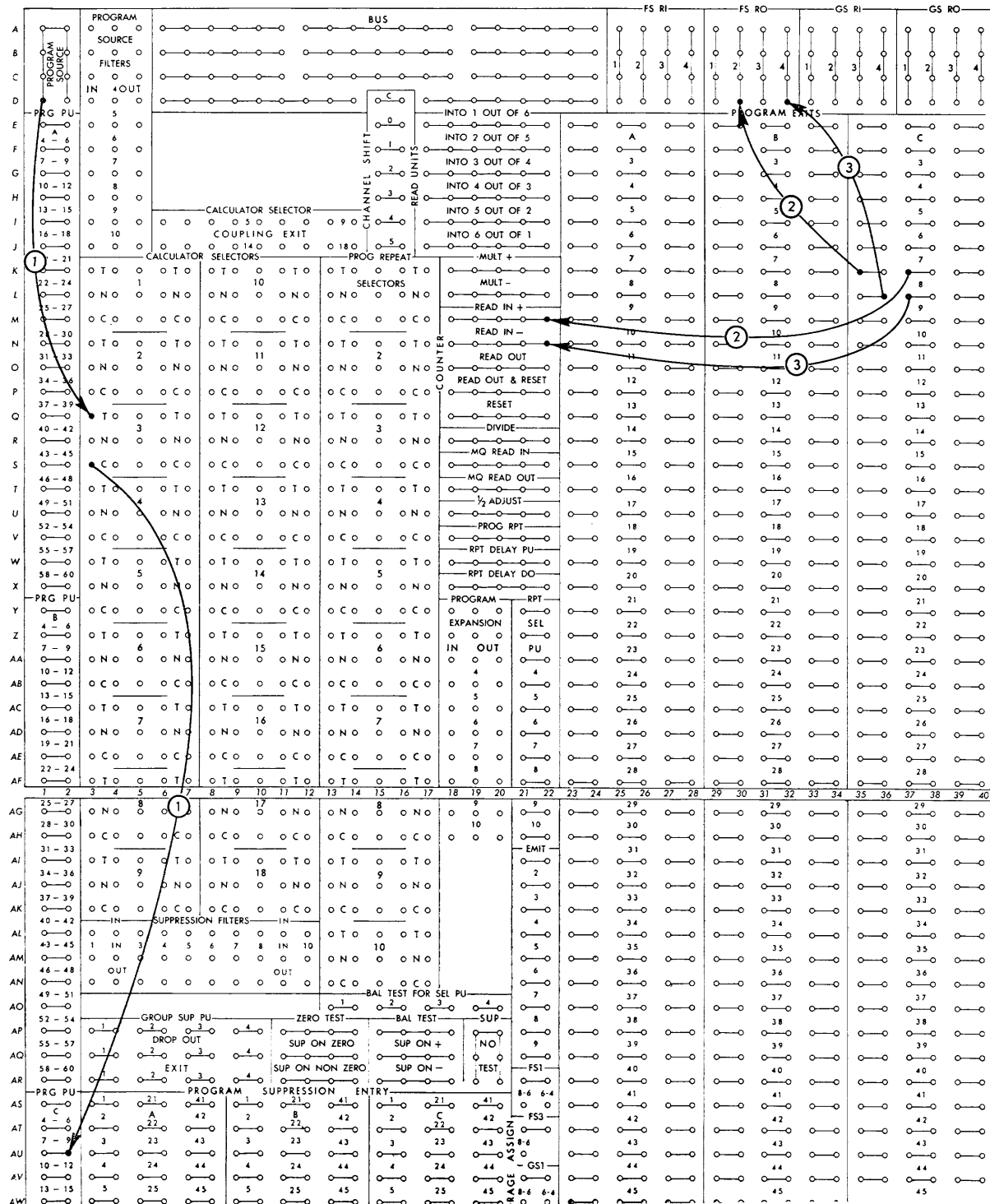

FIGURE 29. A - B = T

Division

$$A \div B = Q \quad \text{Base earnings} \div \text{hours} = \text{Average hourly rate}$$

The calculator has the capacity for dividing a 13-position dividend by an 8-position divisor to obtain a 5-position quotient. If the dividend and divisor are such that the quotient will exceed 5 positions, the operation must be done in parts (quotient expansion). Before dividing, the dividend is read-out from

a storage unit into the counter and shifted to align the decimal point.

To locate the dividend decimal point in the counter, add the number of decimal places in the divisor to the number of decimal places desired in the quotient plus one more place (to allow for 1/2 adjusting the quotient). This result then determines the location of the dividend decimal point and not necessarily the amount of shift required when reading the dividend in the counter.

IBM PLANNING CHART - CPC MODEL A1; CALCULATING UNIT - TYPE 605										PROBLEM				OPERATION <i>DIVIDE A-B=Q</i>			
PROGRAM PICKUP	PROGRAM SUPPRESSION			READ UNITS	OPERATION NOTES	FACTOR STORAGE ASSIGNMENT				MULT QUOT	GENERAL STORAGE ASSIGNMENT						
	1ST	2ND	3RD			1	2	3	4		1	2	3	4			
10				3	DIVIDEND TO COUNTER	A	B										
11					DIVIDE - RESET												
12					1/2 ADJUST												
13																	
14																	
15																	

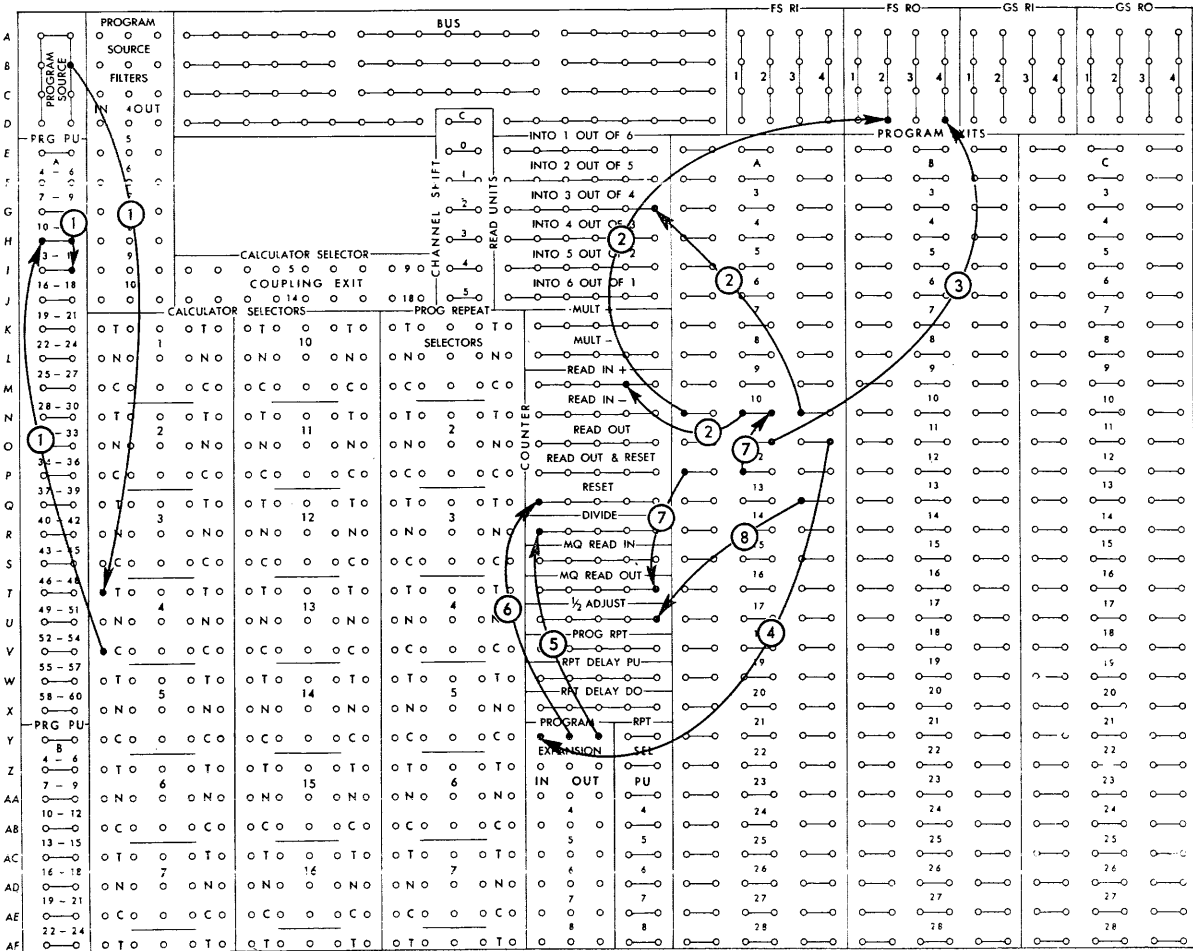

FIGURE 30. $A \div B = Q$

WIRING (FIGURE 30)

1. PROGRAM SOURCE is wired through the transferred side of CALCULATOR SELECTOR 4 to PROGRAM PICKUP A 10-12 and A 13-15.
2. The dividend is read out of FS 2 into the COUNTER +. The shift unit is wired to READ UNITS INTO 3.
3. PROGRAM EXIT A 11 wiring causes the divisor to read out of FS 4.
4. PROGRAM EXIT A 11 is also wired to PROGRAM EXPANSION IN to start a function chain for DIVIDE-RESET.
5. An OUT hub of PROGRAM EXPANSION is wired to DIVIDE.
6. The other OUT hub is wired to RESET. Because the divide hub is wired on the same program step, the counter reset will be delayed until after division is completed.
7. PROGRAM EXIT A 12 is wired to cause the quotient to read-out to the counter. Note that PROGRAM EXIT A 12 is wired to COUNTER READ-IN+ via the double hub of program step 10.
8. The quotient is half-adjusted by the wiring of PROGRAM EXIT A 13.



L, 41-43

N-Y, 47-56

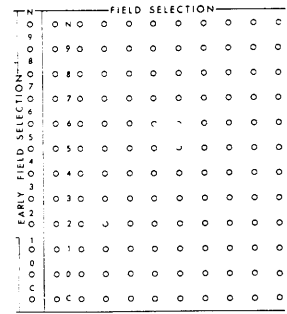

FIELD SELECTOR

THE FIELD SELECTOR is an eleven-level, ten-position selector. Each position has a common, normal, and 10 transferred hubs labeled with digits from 0 to 9.

The pickup for the field selector accepts any digit impulse from 9 to 0. If the pickup hub receives a 3-impulse, it transfers the 10-position selector to the 3-level on the next active machine cycle. This connects the common hub of each of the ten positions to their corresponding 3 level hub. If the field selector pickup receives an 8-impulse, the ten-position selector will transfer to the 8-level on the next active machine cycle, etc.

Figure 31 shows the field selector being used to print sales amount in the printing locations designated

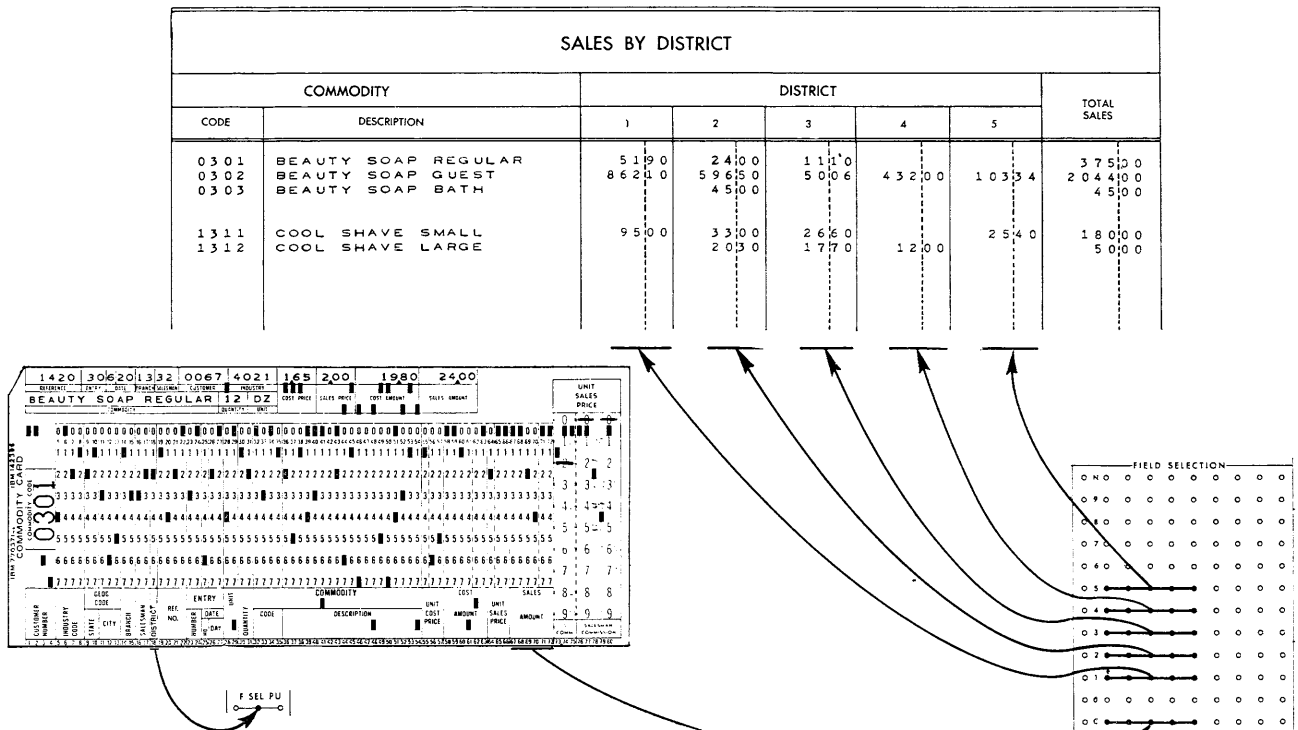

FIGURE 31. FIELD SELECTOR APPLICATION

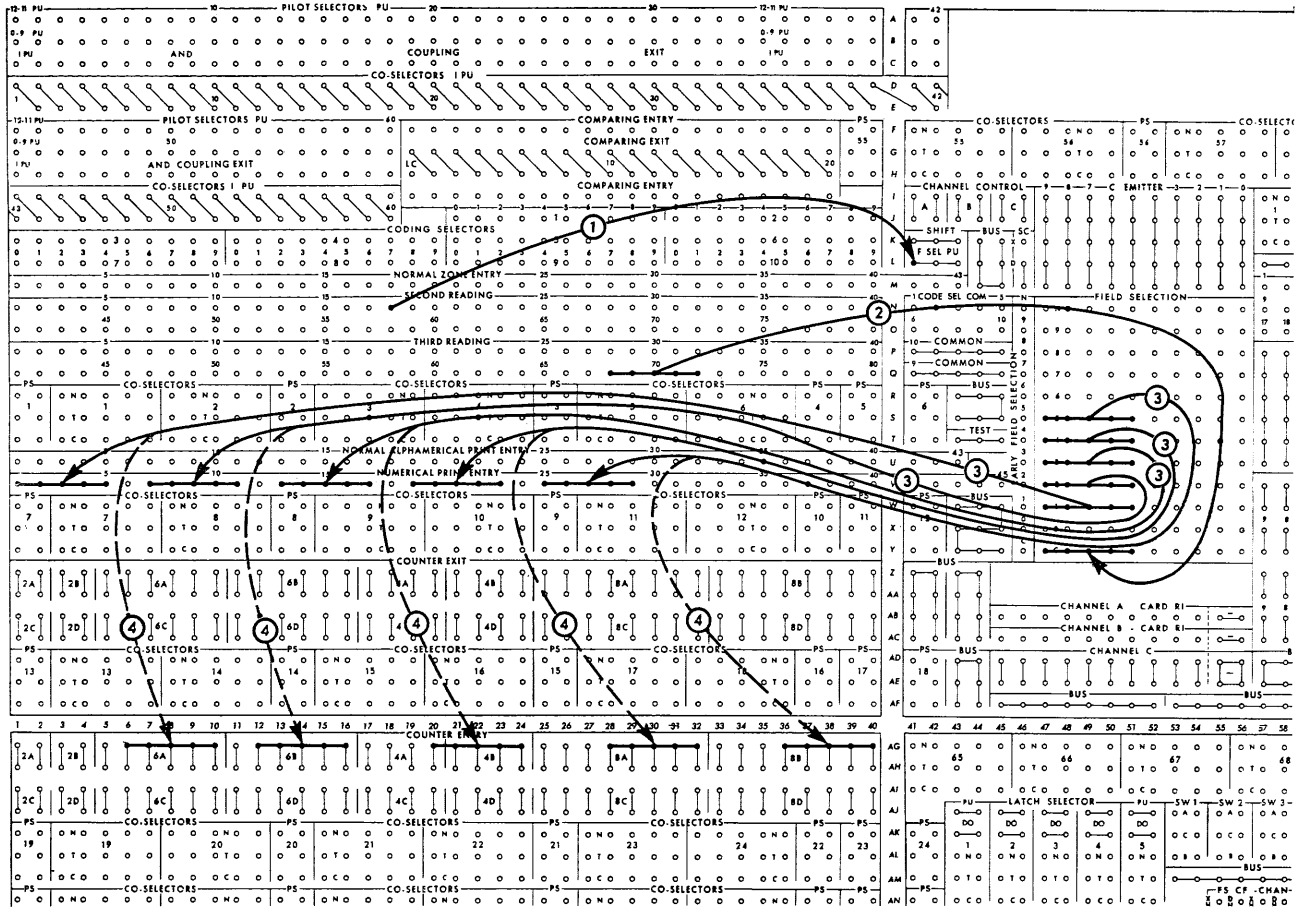

FIGURE 32. FIELD SELECTOR WIRING

by a district code punched in the same card. The dotted wiring shows that district totals may be accumulated in separate counter groups simultaneously.

Wiring (Figure 32)

1. FIELD SELECTOR PICKUP is wired from column 18, SECOND READING. The value of the digit impulse will determine the level of the field selector for the next active machine cycle.
2. Sales amount is wired to the COMMON hubs of the FIELD SELECTOR from columns 68-72 THIRD READING.
3. When the field selector is in level 1, the sales amount will print in the district 1 field of the report. Level 1 positions are wired to NUMERICAL PRINT ENTRY 1-5. Levels 2 through 5 are similarly wired.
4. The dotted wiring from FIELD SELECTOR levels to COUNTER ENTRY hubs shows that selected amounts may also be wired to counter entry positions.

Field Selector Hold

Normally the field selector transfers to its appropriate level on the next active machine cycle following the pickup impulse. When the pickup impulse is received from the last card of a group prior to a minor, intermediate, or major program cycle, the field selector will transfer to the appropriate level on the minor program cycle. It drops back to normal at the end of that minor program cycle. This is advantageous for many applications. However, where card fields are being selected, as in Figure 32, the field selector must not transfer to its appropriate level until the card cycle following the program cycles. To achieve this an impulse to the FIELD SELECTOR HOLD, X or DIGIT, holds the pickup impulse to the FIELD SELECTOR PICKUP hub and delays the transfer of the field selector to its appropriate level until the next card cycle, regardless of program cycles that may intervene.

FS
X O D O
H O H O
AN, 55-56

FIELD SELECTOR HOLD X and DIGIT are entry hubs. When these hubs are impulsed on a card cycle immediately preceding program cycles, the transfer of the field selector to its appropriate level is delayed until the next card cycle. Where card cycles follow in succession, the field selector operation is not affected by the FS HOLD wiring. Normally FS HOLD is wired from the last card of a group or from the impulse that initiates program cycles. When the FS HOLD is used, the FIELD SELECTOR PU hub must be impulsed only once before the next card cycle. If the FS PU receives several impulses, the field selector will transfer to the level corresponding to the highest-value digit received by the FS PU hub.

WIRING

Figure 33 illustrates only the FS HOLD wiring. It does not show FS PU or other field selector wiring.

1. COMPARING ENTRY is wired from SECOND and THIRD READING card fields.
2. COMPARING EXIT is split-wired to MINOR PROGRAM START and to FIELD SELECTOR HOLD DIGIT. Thus the field selector transfers to proper level on first card cycle after minor program.

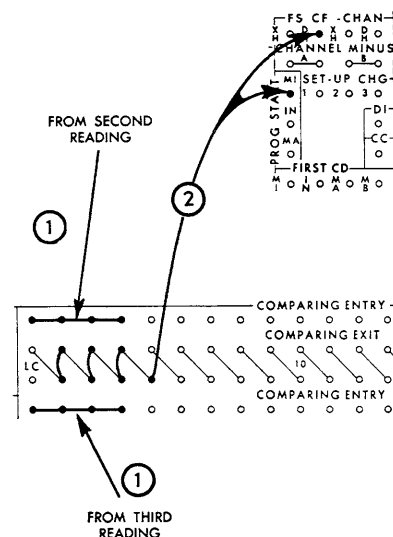
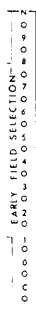

FIGURE 33. FIELD SELECTOR HOLD

impulse. Therefore, it is commonly used to accept the X-punch which identifies a negative or credit number. Figure 34 shows the field selector used to select any one of 4 fields for accumulating in a counter. The fields, A, B, C, D, are wired through the field selector to the counter entry hubs. Because any of the fields may contain either a positive or a negative amount, the counter must add or subtract accordingly. Thus the X-punch identifying the negative field is wired through the early field selector to control addition or subtraction in the counter.

Wiring (Figure 34)

1. SECOND READING, column 18 is wired to FIELD SELECTOR PICKUP.
2. The four fields are wired to levels of the field selector corresponding to the digit code punched in column 18.
3. COMMON of the FIELD SELECTOR is wired to COUNTER 8B ENTRY.
4. The negative X in the units position of each field is wired to the corresponding EARLY FIELD SELECTOR level hub.
5. The X impulse from second reading will pass through the early field selector level (determined by the digit code impulse received by FIELD SELECTOR PU) to PILOT SELECTOR PU.
6. Counter 8B adds when selector 68 is normal, and subtracts when the selector is transferred.



N-Y, 46

Early Field Selector

The EARLY FIELD SELECTOR works in conjunction with the field selector. It has a common, normal, and ten transferred hubs labeled 0-9.

The EARLY FIELD SELECTOR transfers to its designated level on the same cycle that the field selector pickup receives its impulse. If the field selector pickup hub receives a 5-impulse, the early field selector immediately transfers to the 5-level. However, the early field selector accepts only an 11-(X) or 12-

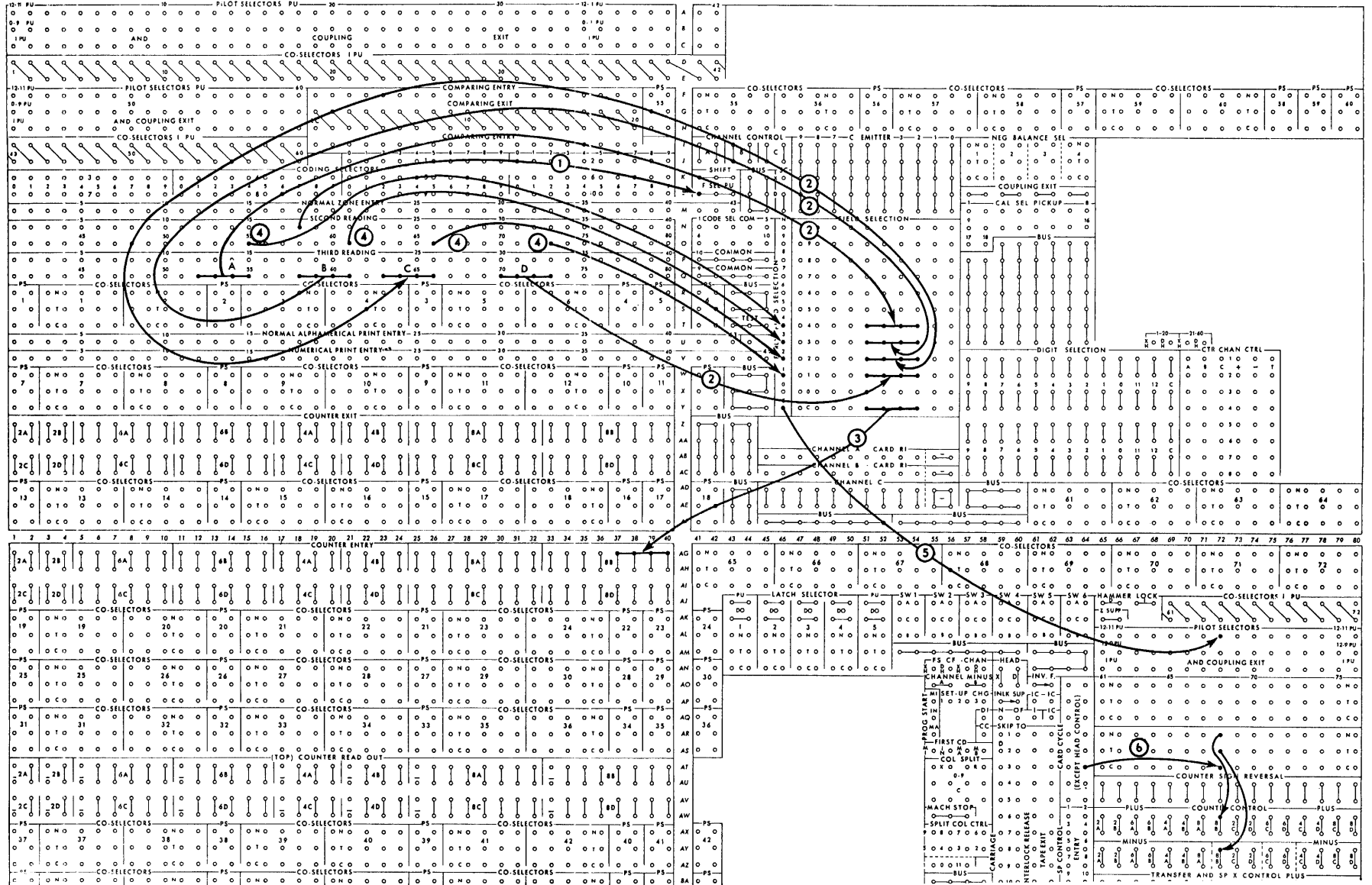

38

FIGURE 34. EARLY FIELD SELECTOR

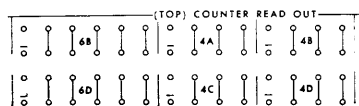

AT-AW, 1-40

TOP COUNTER READ OUT

THESE HUBS are exit hubs for reading out 412 counters without reset. On every machine cycle, the double hub emits a digit impulse which corresponds to the value in that counter position. The high-order position of each counter group has two single hubs. The upper hub is the read-out hub. The lower hub

emits a complement sign impulse if a 9 is standing in the high-order position of the counter. The top counter read-out hubs should not be used on the same cycle that the counter plus, minus, or total hubs are impulsed.

Because top counter read-out hubs emit on every cycle, information such as date, page number, customer number, etc., can be printed anywhere on a report. Figure 35 shows selector control of printing constant information out of counter 6B. Selector pickup is controlled by card punches, program exits, or indicate control hubs depending on the application.

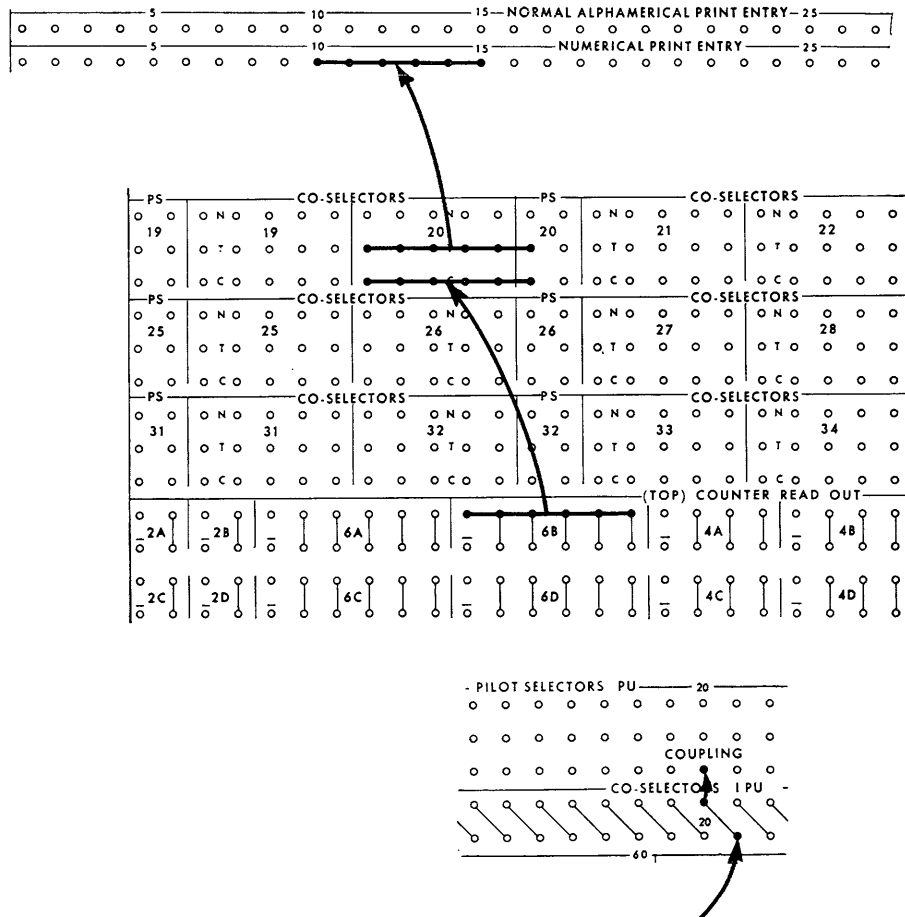

FIGURE 35. TOP COUNTER READ-OUT

PRINCIPLES OF TYPE 941 STORAGE UNIT

EACH STORAGE UNIT contains 16 storage registers arranged into two banks (Figure 36). Eight registers are in the upper bank (bank 1), and eight are mounted in the lower bank (bank 2). Each storage register can store a 10-position number and its corresponding sign. Each register is identified by a two-digit code. Registers 11 through 18 are in bank 1; Registers 21 through 28 are located in bank 2. To read a number into a particular register, or to read out the value contained in the register, it is necessary to refer to the register by its code number. All read-in or read-out of storage registers is controlled from the 412 control panel.

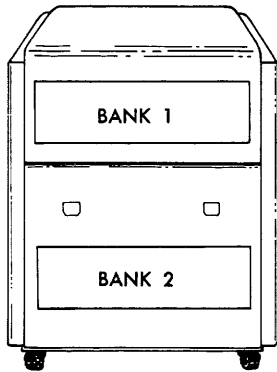

FIGURE 36. TYPE 941 STORAGE UNIT

Two types of control panel hubs are used with 941 storage. The CHANNEL (A, B, C) hubs provide paths for the ten-position number, between all the 941 registers and the 412 machine. Other hubs, called CHANNEL CONTROL (A, B, C), select the specific 941 register that reads in or reads out the 10-position number. The register code number is wired to these hubs.

Figure 37 shows the channel arrangement between the 941 and 412 machines. Numbers to be stored in the 941 are sent over channel C. Numbers are read out of the 941 over channel A and/or channel B. To read in and store a number in a 941 register over channel C, the entry hubs for the number are the channel C hubs. The register code number (example: code 12 for register 12) is wired to the channel C control hubs from a card reading station, or emitted digits. The channel control hubs allow the number to be stored only in the register corresponding to the code number.

Read-out of a number on channel A from a register is accomplished by impulsing channel A control with the code number. Then on the next machine cycle, the value from the register is available on the channel A hubs. Channel B operation is identical to

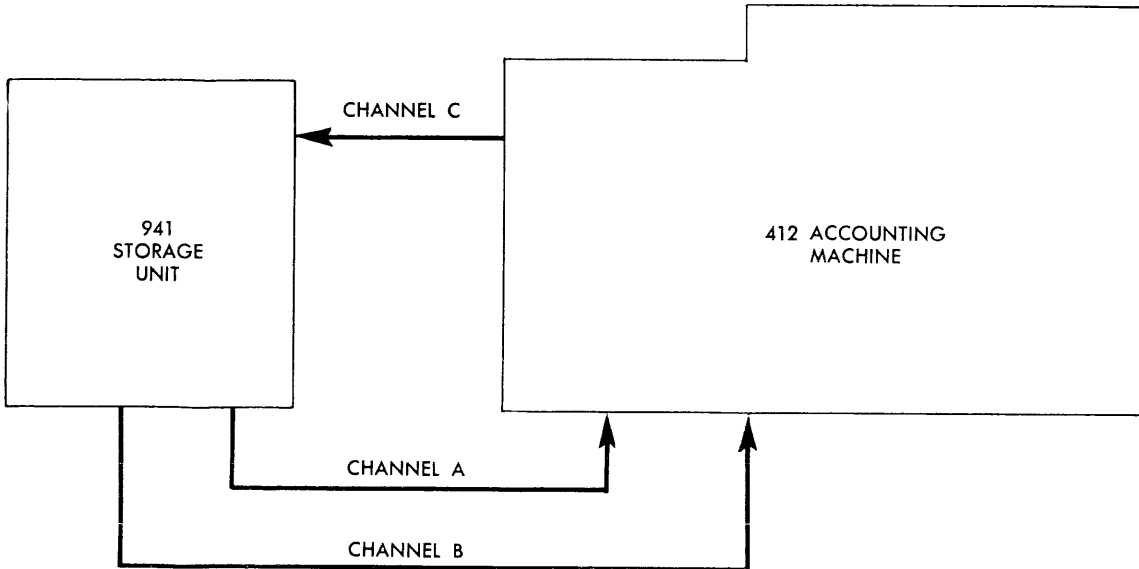

FIGURE 37. SCHEMATIC OF 941 CHANNELS

channel A operation. Thus, a maximum of ten positions of information can be stored in the 941 in one machine cycle. Twenty positions of information may be read-out in a machine cycle.

BANK 1 BANK 2		BANK 3 BANK 4		BANK 5 BANK 6	
11	21	31	41	51	61
12	22	32	42	52	62
13	23	33	43	53	63
14	24	34	44	54	64
15	25	35	45	55	65
16	26	36	46	56	66
17	27	37	47	57	67
18	28	38	48	58	68

ADDITIONAL CAPACITY STORAGE

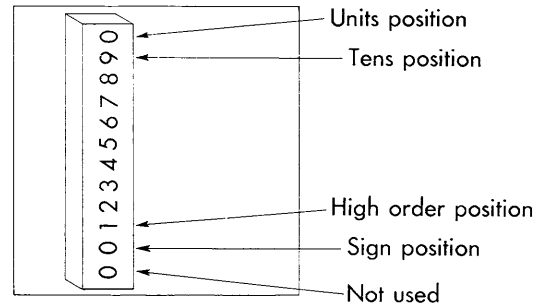

FIGURE 38. +1234567890 STORED IN A 941 REGISTER

Typical examples are:

- 5 0001234560 = negative 1234560 =
- 9 9998765439 = complement form for a negative amount of 1234560

The storage register is not restricted to ten-position numbers. Two 5-position amounts; or two, 3-position and one 4-position amount may be stored in one register. All the amounts in one register should have the same sign and must read-in on the same machine cycle. Read-out of the individual amounts can be wired through selectors to achieve any desired pattern.

Storage in a 941 Register

Positive, negative, or complement numbers are stored in 941 registers. Each register consists of a 12-position unit that is capable of storing a 10-position number and its associated sign. The number in storage will appear as a 12-position number.

Figure 38 shows a positive value in a storage register. A negative number may also be stored in a 941 register. If the negative number is in true form, it has a 5 in the sign position. If the negative number is in complement form it has a 9 in the sign position.

READ-IN FROM THE CARD

STORAGE REGISTER loading from the card is shown in schematic form on Figure 39. The number is read from the card at third reading and wired to channel

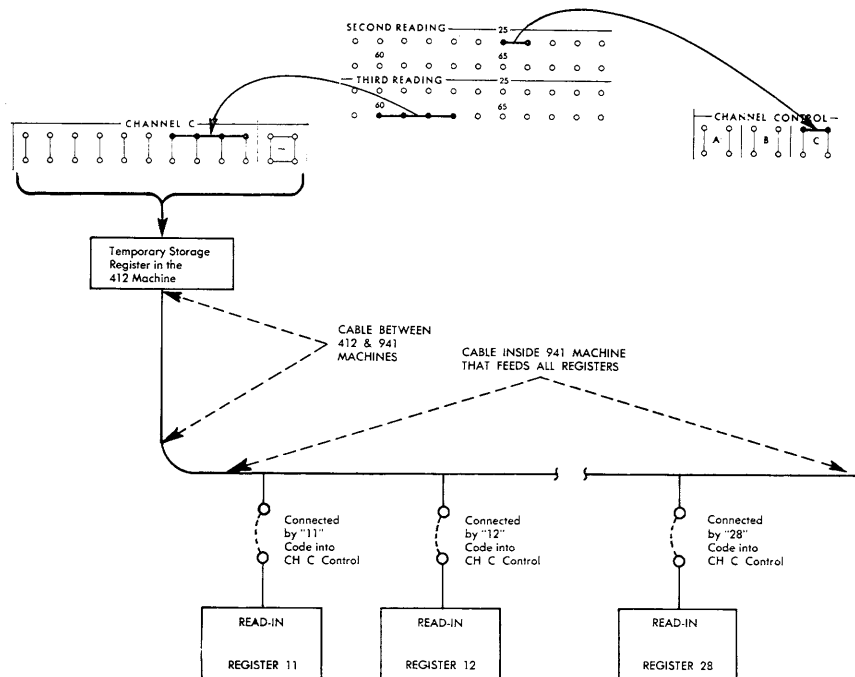

FIGURE 39. TYPE 941 READ-IN SCHEMATIC

C. The register code is punched in the card, and wired from second reading to channel C control. This code determines the register to receive the number being sent over channel C. A number going to the 941 enters a temporary storage register in the 412 and is later transferred to the 941. The temporary storage unit is necessary because the 412 and 941 machines are not mechanically synchronized.

The timing of this transfer is such that it will take two machine cycles for the number to be stored in the 941 register. The first cycle places the number in temporary storage; the second cycle transfers it to the 941. Actually there are two such temporary storage registers in the 412 that alternate automatically, one being ready to receive, the other to transmit to the 941. This permits 941 registers to be loaded on successive cycles. Thus two active machine cycles (or two card cycles) must intervene between the instruction causing a 941 read-in and the instruction calling for a read-out from the same storage register.

BL, 21-22

Storage Interlock Switch

This switch provides a power interlock between the 941 and 412 main line switches. It should be jack-plugged whenever 941 units are being used. This switch prevents the 412 machine from starting until the mainline switch is turned on in all the 941 units that are connected.

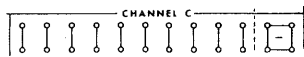

AD-AE, 45-56

Channel C

These are the entry hubs for reading a 10-position number (and its sign) into the 941 storage register. The sign of a negative number (example, X over units position of the number) is wired from the second reading column to channel C sign hub.

The sign hub will also accept a 10-impulse on the same cycle as the number is received to identify it as a negative number. This sign impulse will place a 5 in the sign position of the storage register when the number is actually stored in the 941.



I-J, 45-46

Channel C Control

CHANNEL C CONTROL hubs accept the two-digit register code and connect the channel C positions to the specific register identified by the code.

The tens position of CHANNEL CONTROL has another function. Any digit impulse received by the tens-position hub causes the CHANNEL C COMMON (BI, 38-40) to emit. The CHANNEL C COMMON is normally wired to cause read-out of the 605 counter or 605 storage.

A number may be simultaneously entered into more than one register in the same bank by multiple punching the CH C CONTROL code in the units position. For example a 1 in the tens position and a double-punch 3 and 4 in the units position would enter the number in registers 13 and 14. A double-punch in the tens position should not be used because the random timing relationship between banks will not allow multiple entry of a factor into separate banks.

Wiring (Figure 40)

1. STORAGE INTERLOCK switch is jackplugged.
2. SECOND READING, columns 10 and 11, read the CHANNEL C register code and are wired to CHANNEL C CONTROL. This designates the storage register to be read into.
3. THIRD READING columns 20-29 wired to CHANNEL C enter the number on the channel.
4. The dotted wiring shows how the sign of a negative number is handled. SECOND READING column 29 is wired to CHANNEL C SIGN.

READ-IN FROM ELECTRONIC COUNTER

RESULTS of calculations may be stored in the 941 registers by wiring from the 605 counter exit to channel C. The register code wired to channel C control, which designates the proper storage register to read-in, may be punched in a card or emitted through selectors. Amounts or results may be sent to the 941 over channel C in one of two ways. Either they are sent directly from the 412 to the 941 or they are sent

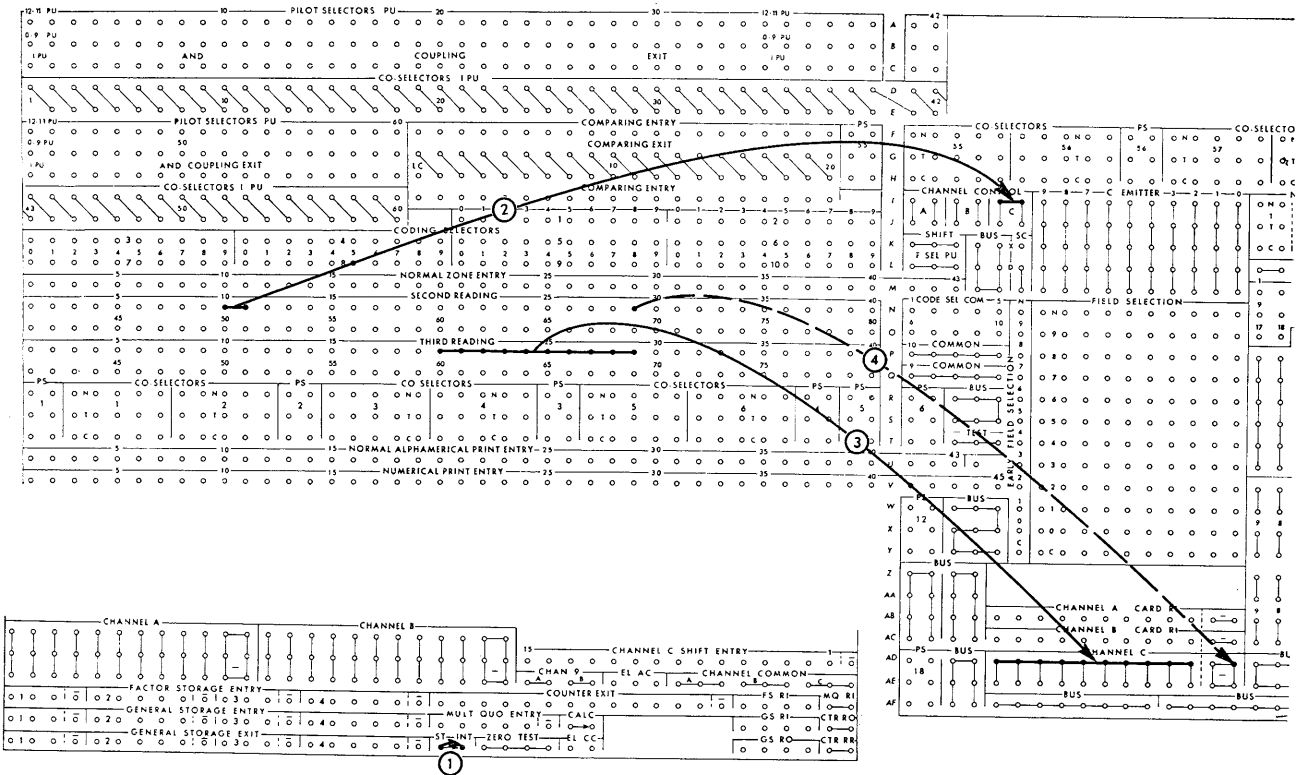

FIGURE 40. TYPE 941 READ-IN FROM CARD

from the 412, through the 605 and then to the 941. (This latter method requires an additional cycle, and therefore channel C control must be wired from third reading or the emitted register code must be sent to channel C control on the third reading cycle.) Therefore, CHANNEL C CONTROL is wired as follows:

1. From SECOND READING when loading 941 registers directly from card fields, or
2. From THIRD READING to direct the storage of calculated results which are read out of the 605 counter on the next cycle, or
3. From the emitter through a selector. The selector is wired so that the emitted register code is re-

ceived by CHANNEL C CONTROL on the machine cycle preceding the one in which the factor arrives on CHANNEL C.



BI, 38-40

Channel Common

CHANNEL C COMMON emits an impulse which is used to cause the 605 general storage units and counter to read-out or to read-out and reset. This hub emits only if CHANNEL C CONTROL (tens positions) received an impulse on the previous cycle.

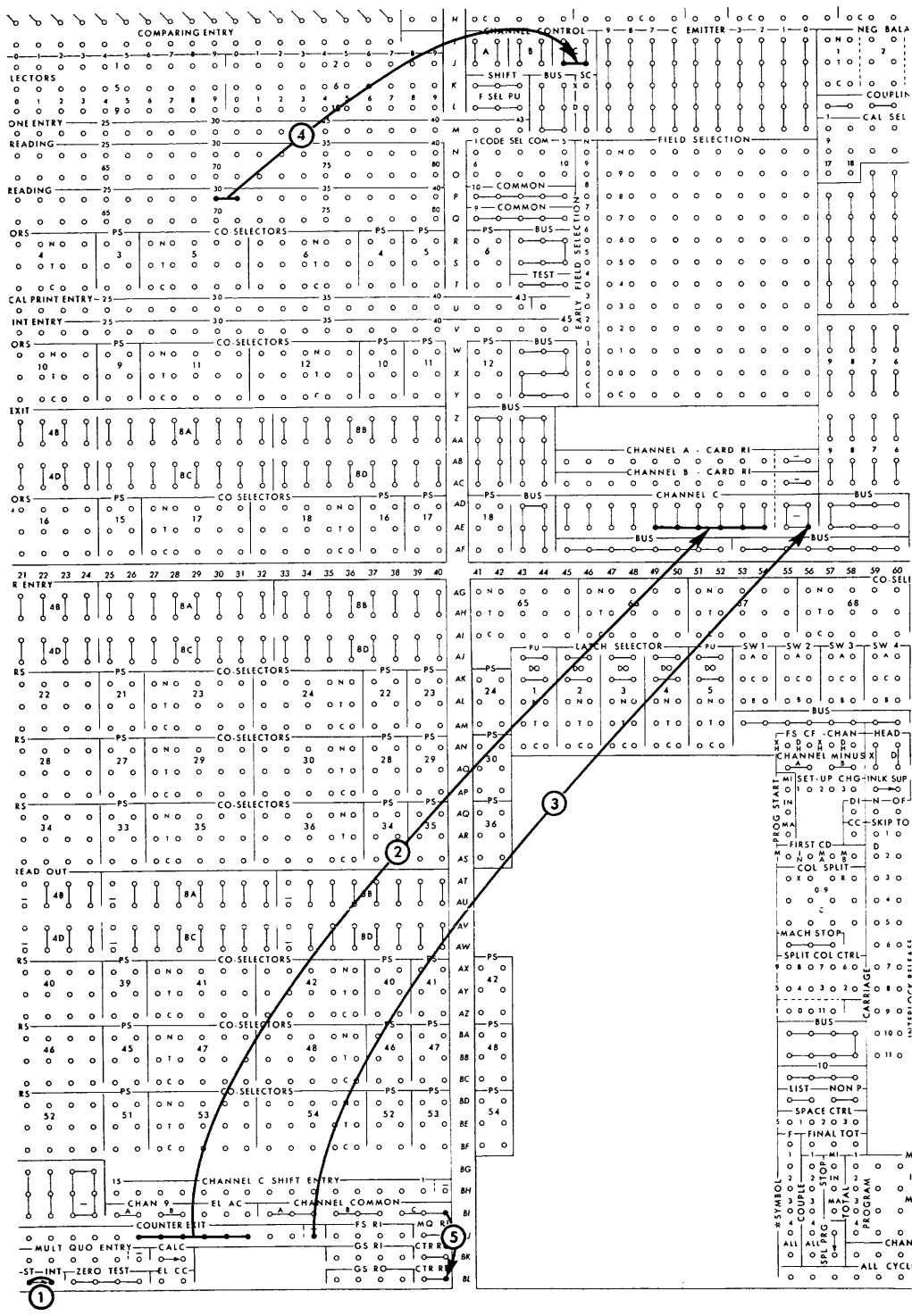

FIGURE 41. TYPE 941 READ-IN FROM 605 ELECTRONIC COUNTER

Wiring (Figure 41)

1. STORAGE INTERLOCK switch is jackplugged.
2. 605 COUNTER EXITS are wired to CHANNEL C.
3. COUNTER SIGN EXIT is wired to CHANNEL C SIGN so that negative results are stored with a negative sign.

4. THIRD READING wired to CHANNEL C CONTROL to select the read-in to a specific register.
5. CHANNEL C COMMON to COUNTER RR. CHANNEL C COMMON emits because CHANNEL C CONTROL, tens position, received an impulse on the previous cycle.

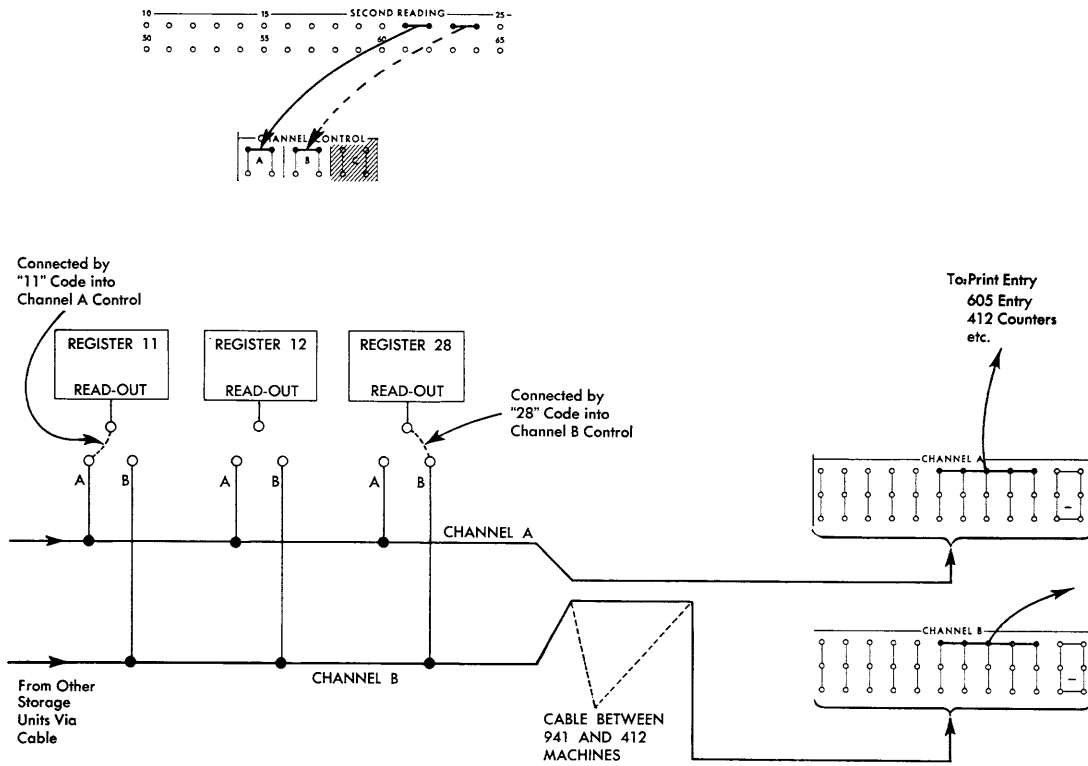

FIGURE 42. SCHEMATIC OF 941 READ-OUT

STORAGE READ-OUT

INFORMATION may be read-out of two storage registers on the same cycle. The 941 storage exits are called CHANNEL A and CHANNEL B. A schematic of this is shown on Figure 42. The register code (punched in a card) wired from second reading to channel A control causes a specific register to read-out its amount. For example, a register code punched 11 in the card and wired to channel A control causes the amount in register 11 to be read-out of channel A on the third reading cycle. This amount can then be wired from channel A to print, and/or read into 605 storage units, or 412 counters. Similarly, if a register code 11 is wired to channel B control, the amount in register 11 is available on channel B to be wired to other CPC units.

The channel A and B control fields of the card must not be double-punched, nor should multiple impulses be sent to these hubs. Either of these methods would lead to erroneous operations. A double impulse into the tens-position hub would cause two registers in separate banks to read-out. The banks read out would correspond to the values of the double-

punched code and the register selected would be determined by the highest value impulse received at the units-position hub. The units-position hub of channel A, B control accepts only the highest value impulse if multiple impulses are received.

Two active machine cycles (or two card cycles) must intervene between the instruction causing a 941 read-in and the instruction calling for a read-out from the same storage register.

READ-OUT ON PROGRAM CYCLES

THE 941 storage registers may read-out on card cycles or on program cycles. Figure 42 illustrated card cycle read-out wiring. Figure 43 shows the wiring for read-out on program cycles. In this example an impulse into major program start initiates the program cycles.

On the minor program cycle, channel A receives an emitted 11-code, and channel B receives an emitted 28-code. This causes register 11 and 28 to read out on the next cycle (intermediate cycle). Thus, a cal-

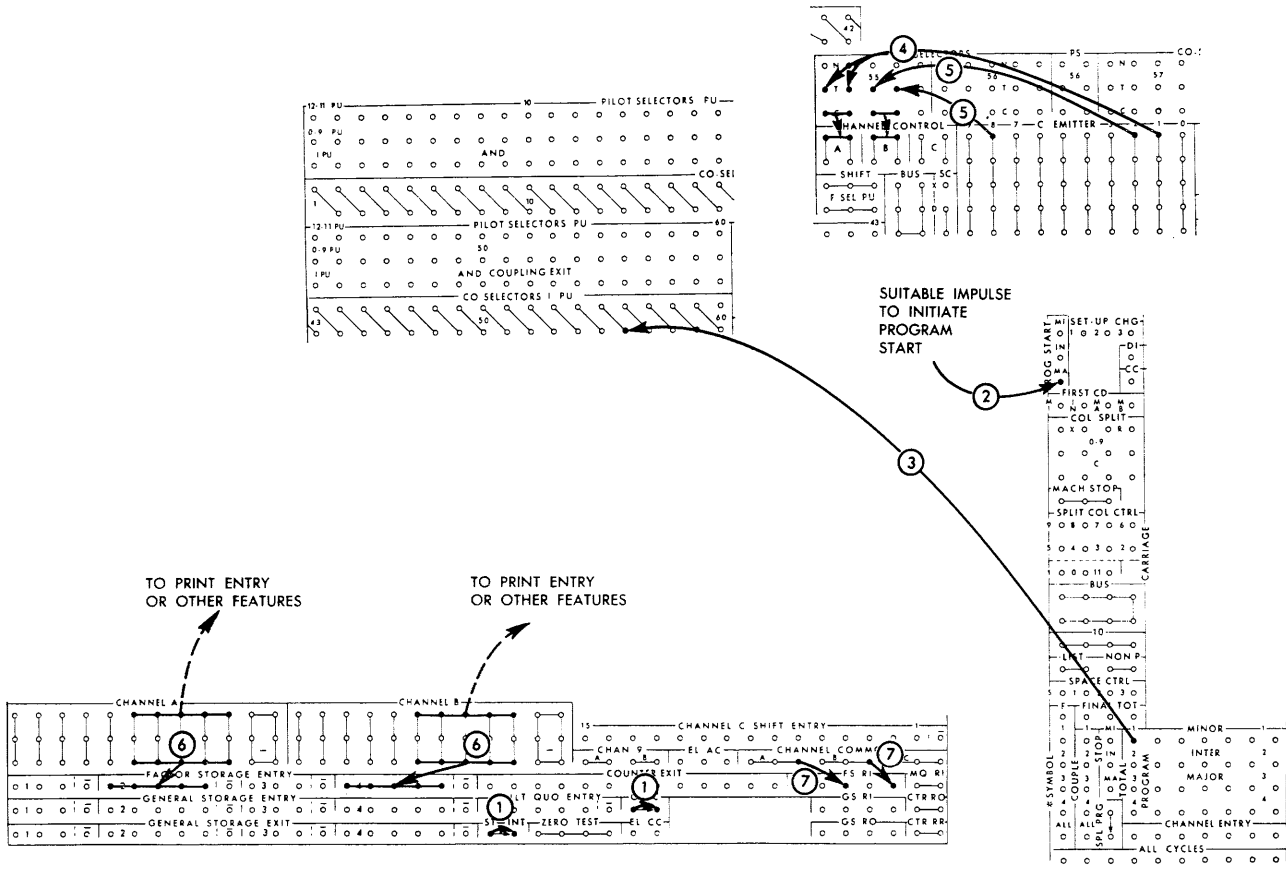

FIGURE 43. TYPE 941 READ-OUT ON PROGRAM CYCLES

calculation using these factors could be performed in the 605 on the intermediate program cycle. The result of this calculation is available to the 412 machine, from the 605 exit hubs, on the major program cycle. This same technique can be used with the special programming feature to program several read-outs and calculations on successive program cycles.

Wiring (Figure 43)

1. The STORAGE INTERLOCK and CALCULATE switches are jackplugged.
2. A major program cycle is initiated by other control panel wiring (not shown). This will force a minor followed by an intermediate program cycle.
3. CO-SELECTOR 55 is picked up by a MINOR PROGRAM impulse.
4. The C-EMITTER is wired to emit 11 through the transferred side of CO-SELECTOR 55 to the CHANNEL A CONTROL HUBS.
5. The C-EMITTER emits a 28-code to CHANNEL B CONTROL through CO-SELECTOR 55.
6. On the next cycle (intermediate program) the number from register 11 is available on CHANNEL A. It is wired to FACTOR STORAGE ENTRY. Dotted wiring indicates it could also be wired to print if desired. CHANNEL B wiring shows the number from register 28 wired to read-in FACTOR STORAGE 4 ENTRY.
7. CHANNEL A COMMON and CHANNEL B COMMON emit a ten impulse which is wired to FACTOR STORAGE READ-IN.

Channel Common

CHANNEL A COMMON emits a 10-impulse on the cycle following the one in which the CHANNEL A CONTROL tens-position hub received an impulse (register code). The CHANNEL A COMMON may be wired to FS, GS, or MQ READ-IN hubs. Any digit impulse into the tens position of channel control will cause the corresponding channel common to emit. Similarly CHANNEL B COMMON emits a 10-impulse when the CHANNEL B CONTROL hubs receive a register code impulse.

Card Read-in Via Channel A or B

In applications where the 941 read-out exits, channel A and B, are wired to 605 storage entry hubs it is often desired to read directly from the card into these 605 storage units. This may be done either by wiring directly from third reading to 605 storage entry or by wiring from the card into CHANNEL A or B CARD RI hubs. The CHANNEL A CARD RI hubs are internally connected to CHANNEL A hubs by wiring a digit O-impulse to the CHANNEL A CONTROL (tens position) hub. In other words, an O impulse to channel A control will allow a number to be read from the card directly into 605 factor storage units via channel A.



AB-AC, 45-56

Channel A Card RI, Channel B Card RI

These hubs are entries for reading numbers from the card to channels A and B. They are normally wired from third reading. An O-impulse into the tens position of channel control connects these channel card read-in hubs to the corresponding channel A or B.

Negative numbers are usually identified by an X over the units position of the amount field. A nega-

tive number may also be identified by a digit code in a column. Where the X-punch signifies a negative number, special hubs called CHANNEL MINUS are used and the sign (-) hub of CHANNEL CARD RI must not be used. The sign (-) hub of CHANNEL CARD RI can be used only if the negative number is signified by a digit code 9-0: This code is wired from third reading.



AO, 55-58

Channel Minus

These hubs are entries for the sign associated with a negative number that is read from the card to channel A or B. The hubs accept only 11- (X) and 12-impulses. They are normally wired from second reading.

Wiring (Figure 44)

1. CALC. switch is jackplugged.
2. CHANNEL A is wired to FACTOR STORAGE ENTRY. The channel A hubs are in effect the exit hubs for 941 storage registers.
3. Columns 21, 22 of SECOND READING are wired to CHANNEL A CONTROL. A zero in column 21 causes the CHANNEL A CARD READ-IN hubs to be connected to CHANNEL A.

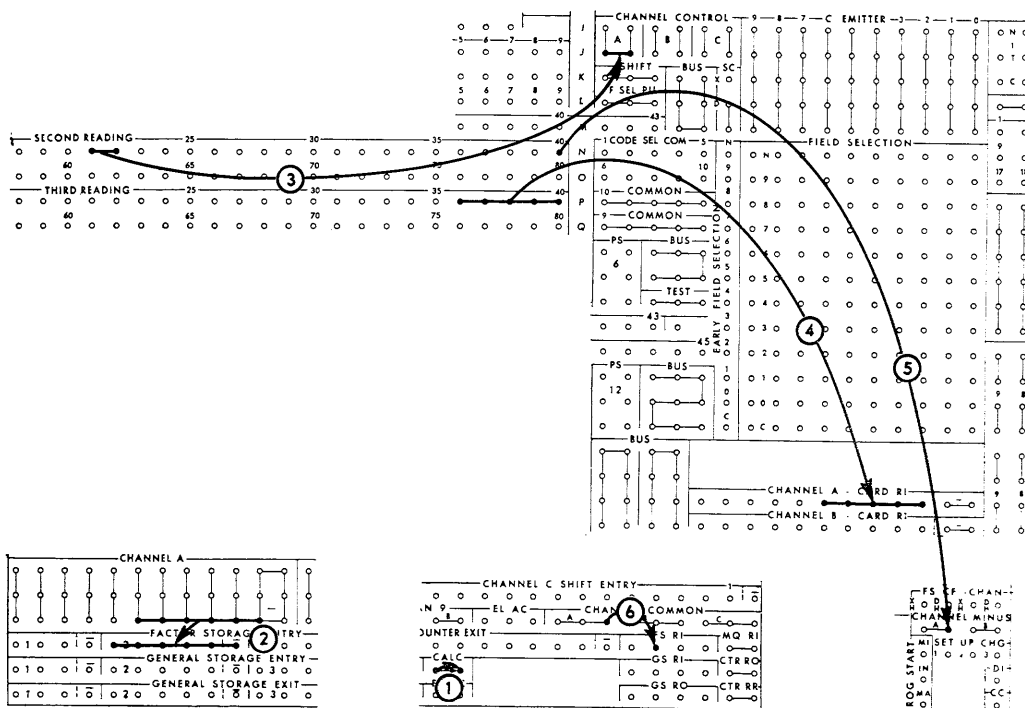

FIGURE 44. CARD READ-IN TO 605 VIA CHANNEL A

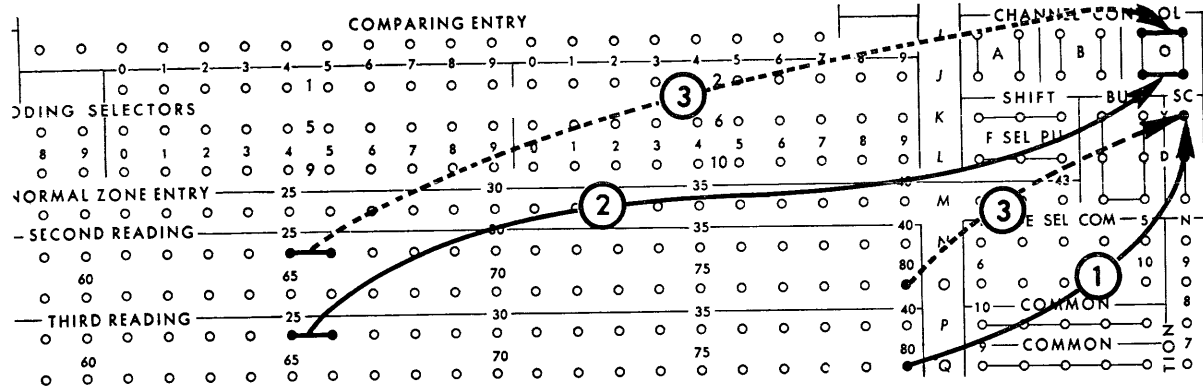

FIGURE 45. STORAGE CLEAR

4. THIRD READING columns 36-40 are wired to CHANNEL A CARD RI. Information in this card field will be read into FACTOR STORAGE 2 (see *Wiring 2*).

5. A negative amount in the card is identified by an X in column 40. The CHANNEL A MINUS hub accepts this X from SECOND READING, and through the channel-A-sign-hub wiring, causes the sign of the number in factor storage 2 to be negative.

6. CHANNEL A COMMON emits a 10-impulse to reset FS 2.

941 storage unit will clear to zeros. A 2-impulse to the tens position of channel C control along with a storage clear impulse will cause all the storage registers in bank 2 to clear. The storage banks are interlocked so that only one may be cleared at a time. The X-hub of storage clear will accept only 11- and 12-impulses. The D-hub will accept any digit (9 through 12). The storage clear hub must be wired to the same reading station as the channel C control hubs are wired.

Wiring (Figure 45)

1. Column 80 THIRD READING is wired to STORAGE CLEAR X.
2. Digits punched in column 25 impulse the CHANNEL C CONTROL hub to select the 941 bank to be cleared.
3. The dotted wiring shows that if CHANNEL CONTROL is wired from SECOND READING, the STORAGE CLEAR feature must be wired from SECOND READING.



K-M, 46

STORAGE CLEAR

WHEN storage clear is impulsed on the same cycle that channel C control receives a digit 1 impulse in the left-hand (tens) position, the first bank of the

CHANNEL C SHIFT UNIT

THE ACCOUNTING MACHINE has a shift unit that is capable of shifting a ten-position number a maximum of 6 places. It contains a shift pickup, a 15-position shift entry, and a 10-position shift exit (channel C hubs). The pickup hub accepts digits 1 through 5. A digit 2 causes a shift of two, a digit 5 sets up a shift of 5. Normal usage is to wire 605 COUNTER EXITS to SHIFT ENTRY and THIRD READING to the SHIFT PICKUP. Thus a shift code in the card can select the counter positions to be read out to CHANNEL C.

Figure 46 shows a schematic of the shift unit and the internal shifted connections for normal shift, shift 1, and for shift 5. Note the sign hub of shift entry is always internally connected to the sign hub of CHANNEL C.

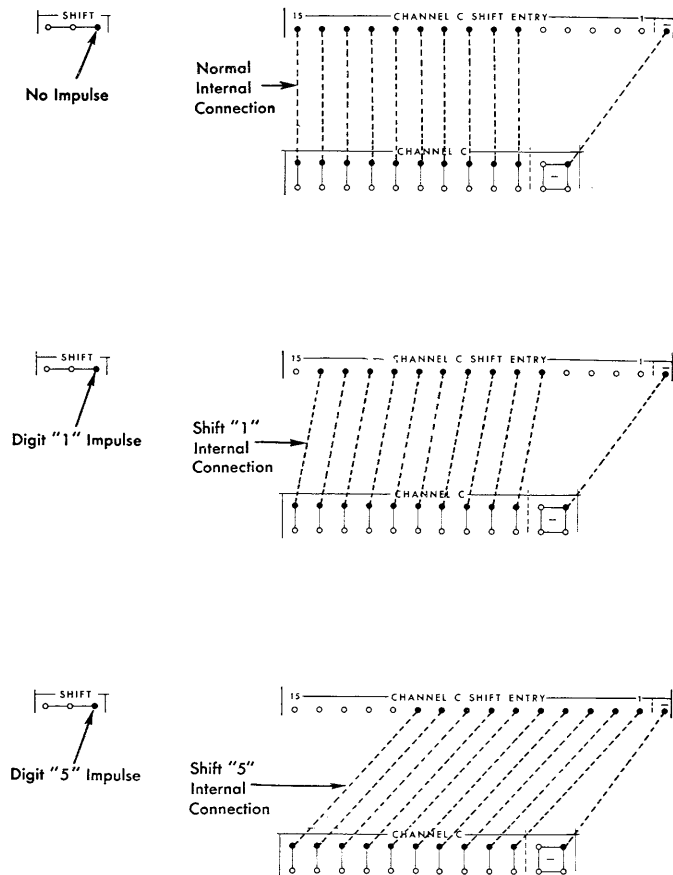

FIGURE 46. CHANNEL C SHIFT SCHEMATIC

SHIFT
K, 41-43

Shift Pickup

The SHIFT pickup accepts digits 1 through 5. The digit value determines the amount of shift. Normally the 6th position of shift entry is internally connected to the units position of channel C. The 7th position of shift entry is connected to the tens position of channel C, etc. A digit 1 into the pickup hub connects the 5th position of shift entry to units of channel C. Thus, the shift entry unit shifts to the right a number of places corresponding to the value of the shift-pickup digit. A shift of 6 positions is possible by double-punching the shift code with the digits 4 and 2, or digits 5 and 1, or digits 1, 2, 3.

CHANNEL C SHIFT ENTRY
BH, 25-40

Channel C Shift Entry

These entry hubs accept a number and deliver it to the channel C hubs. The schematic (Figure 46) shows the internal connections for various shifts. These hubs are normally wired from the 605 counter or general storage exits.

CHANNEL C
AD-AE, 45-56

Channel C Hubs

The CHANNEL C hubs have previously been explained as the entry positions to 941 storage registers. They also serve as an exit for the channel C shift unit. Thus a selected 10-position of the 605 counter, if wired to channel C shift entry, could be read-out of the 605 and stored in a 10-position 941 register.

Typical Channel C Shift Wiring

In CPC applications, one type of card calls for one of several programs stored in the calculator program wiring. For example, in a billing application, the commodity card calls for quantity x unit price; the

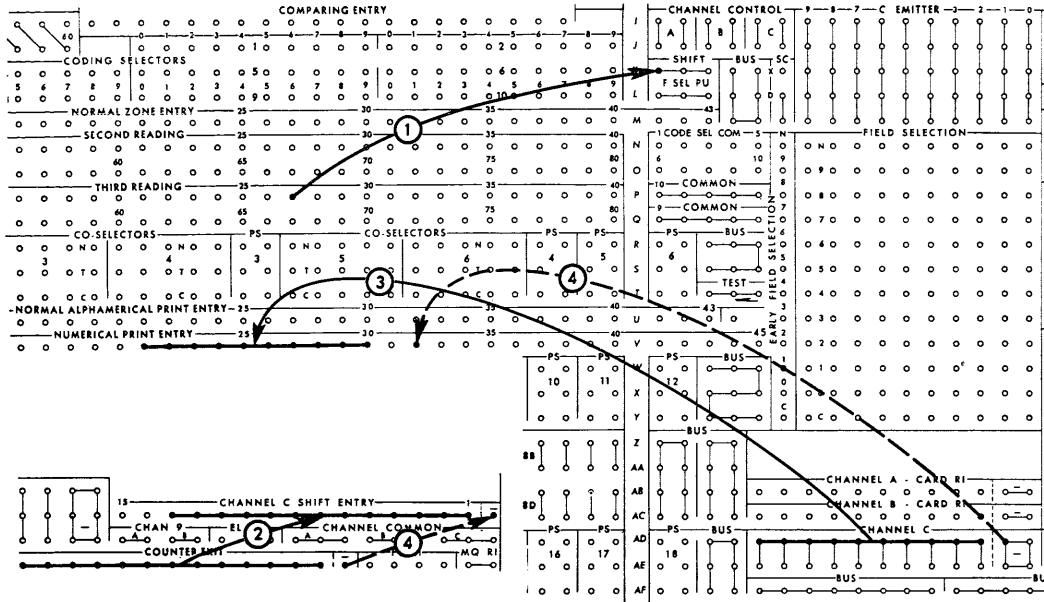

FIGURE 47. CHANNEL C SHIFT WIRING

sales tax card would require invoice amount x a percentage; discount cards or freight cards call for their own program of calculation. The results of each of these calculations may place the decimal point in a different position of the electronic counter. The shift code punched in each of these cards selects the positions of the counter to be read out to print. A shift code of 5 reads out the 10 lower positions of the counter. A shift code of 3 drops the units and tens positions of the counter and connects the hundreds counter position to the units of channel C.

Wiring (Figure 47)

1. The shift code is wired from THIRD READING because the 605 result will be read-out for that card on the next machine cycle (cycle 4).
2. COUNTER EXIT is wired to CHANNEL C SHIFT ENTRY. The units position of the counter is wired to the units position of shift entry.
3. CHANNEL C wired to PRINT ENTRY to record the results.
4. The dotted wiring shows how negative results from calculator may be printed.

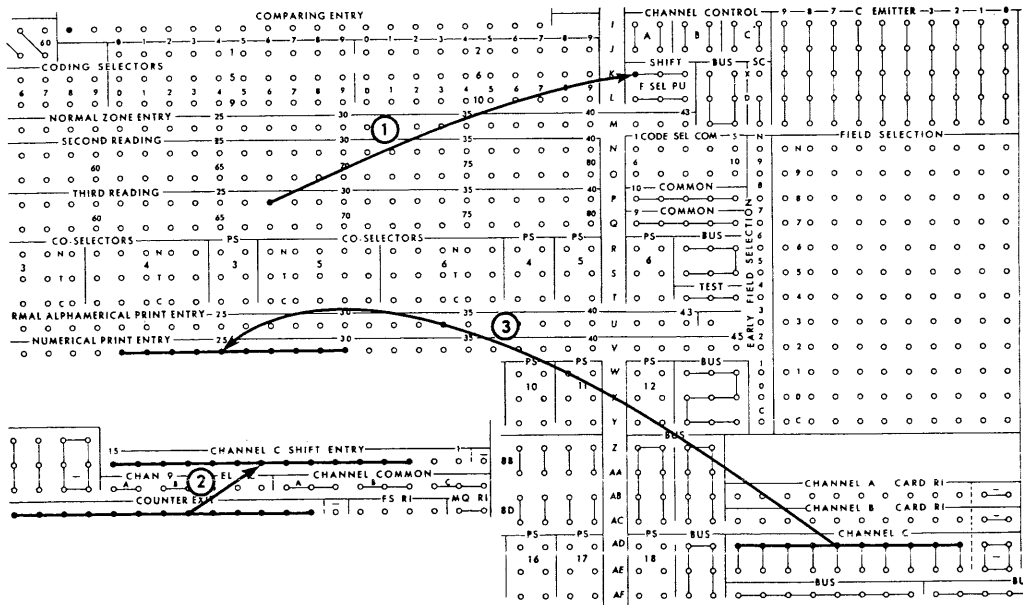
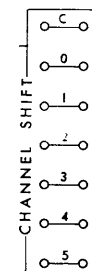

FIGURE 48. WIRING FOR CHANNEL C SHIFT

Channel C Shift Wiring from 605 Counter Exits

Applications requiring read-out of the high-order position of the 605 counter may be wired as shown in Figure 48. In this example, a normal shift would read-out the high-order ten positions of the counter; a shift of five would read-out from the low-order eight positions of the counter.



D-J, 15-16

Wiring (Figure 48)

1. The SHIFT hub is wired from THIRD READING, column 27.
2. CHANNEL C SHIFT ENTRY is wired from COUNTER EXITS; high order to high order-position, etc.
3. CHANNEL C wired to print in NUMERICAL PRINT ENTRY.

605 Channel Shift

The 605 CHANNEL SHIFT unit is associated with the channel C shift unit of the 412 accounting machine.

The 605 channel shift unit has 7 pairs of hubs. They are labelled C, 0, 1, 2, 3, 4, 5. Normally the C-hubs are connected to the 0-shift hubs. The channel shift unit will transfer to level 1, 2, 3, 4, or 5 when the shift hub on the 412 control panel receives a corresponding digit impulse.

Figure 49 shows a typical application of this feature. The channel shift unit is used to select the placement of the 1/2 adjust digit to correspond with the selection of 605 counter exits through channel C shift on the 412 control panel. Figure 47 shows the 412 control-panel wiring.

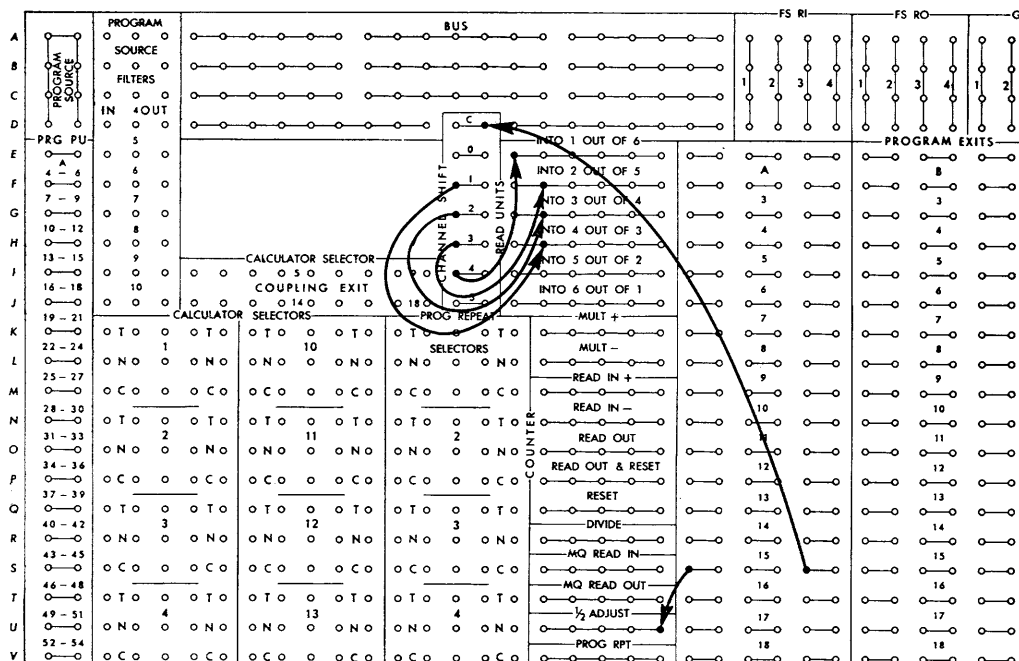
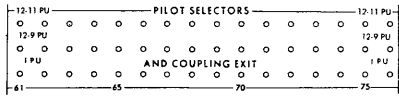

FIGURE 49. TYPE 605 CHANNEL SHIFT WIRING

SELECTORS

Co-Selectors

The immediate pickup accepts an impulse to transfer the selector at any time except between 225°-252°. Typical pickup impulses and the length of selector transfer are shown in Figure 50.



AL-AT, 65-80

Pilot Selectors 61-76

These selectors operate in the same manner as standard 402 pilot selectors. Typical uses are shown in Figure 51. The pickup hubs are labelled 12-11 and 12-9 instead of X-pickup and digit pickup as they are labelled on the Type 402. The 12-9 pickup also accepts a 10-impulse in addition to the digits 9 through 12, negative balance, and coupling exit impulses.

The timing chart in the manual supplies additional information on selector timing.

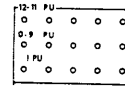

A-C, 1-42; F-H, 1-18

Pilot Selectors 1-60

These pilot selectors differ from the conventional Type 402 pilot selectors in that they do not hold up through intervening program cycles and the digit pickup (0-9) does not accept an 11- or 12-impulse. If the 12-11 or 0-9 pickup is impulsed on the last card cycle before program cycles, the selector drops out during the first program cycle. If these pickups are impulsed on a minor program cycle, the selector drops on the intermediate program cycle. This is more clearly illustrated by the following examples (Figure 52). The I-pickup of pilot selectors accepts the same impulses as a co-selector pickup (Figure 50).

Note the differences between pilot selector operation by comparing Figure 51 with Figure 52. This comparison shows the differences in operation between pilot selector 61-76 and pilot selector 1-60.

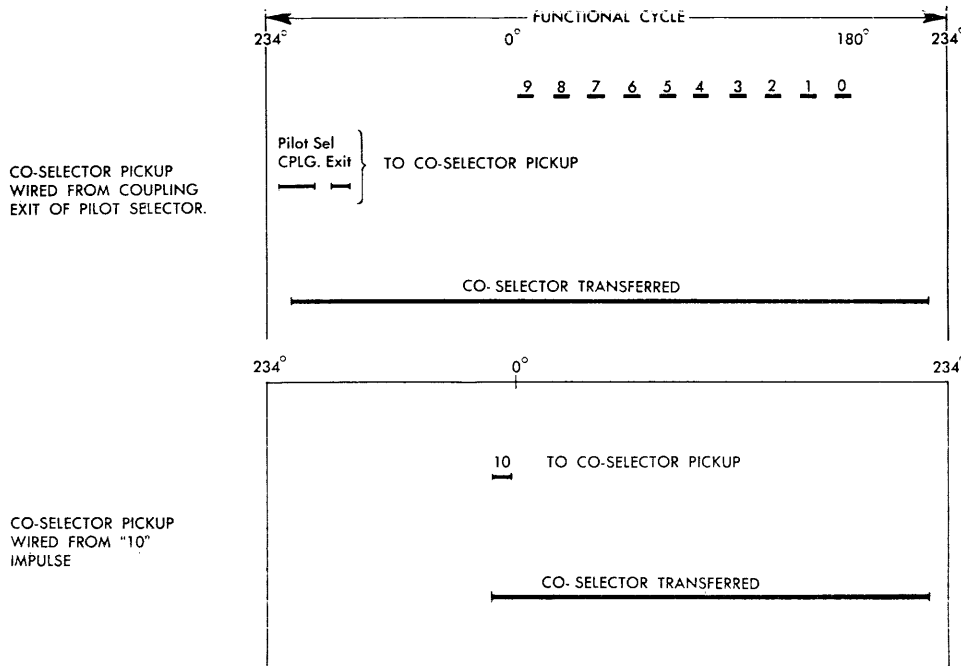

FIGURE 50. CO-SELECTOR OPERATION

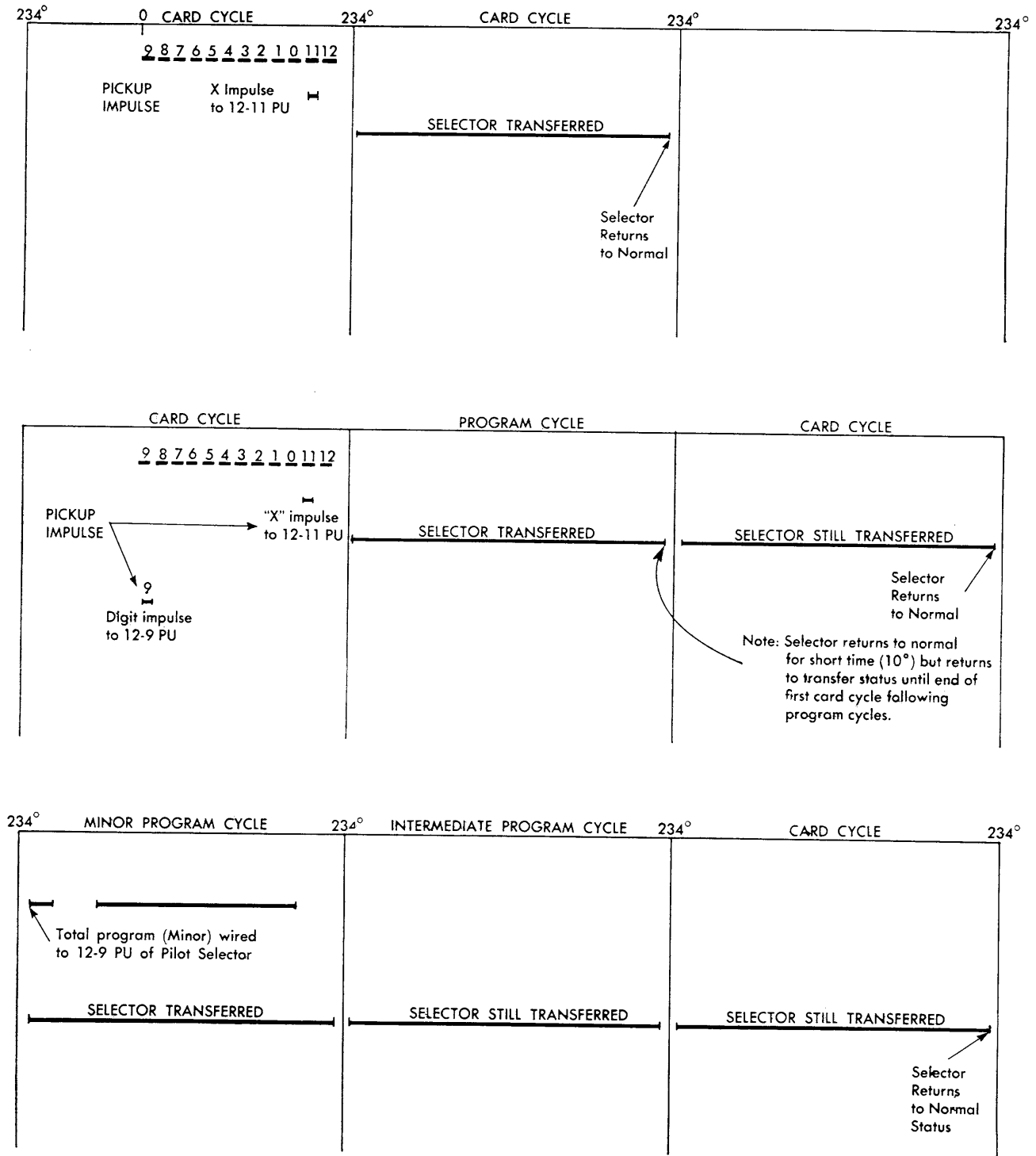

FIGURE 51. PILOT SELECTORS 61-76

U, 68-71

Pilot Selector Hold

Pilot selectors 1-60 can be controlled to hold up through intervening program cycles in the same way

that conventional 402 pilot selectors do (Figure 51). An impulse into the X- or D-hub 1-20 of the PILOT SELECTOR HOLD feature causes pilot selectors 1-20 to operate similar to pilot selectors 61-76. Pilot selectors 21-60 can be controlled as a group to operate in the same manner as pilot selectors 61-76 by impulsing the appropriate X- or D-hub.

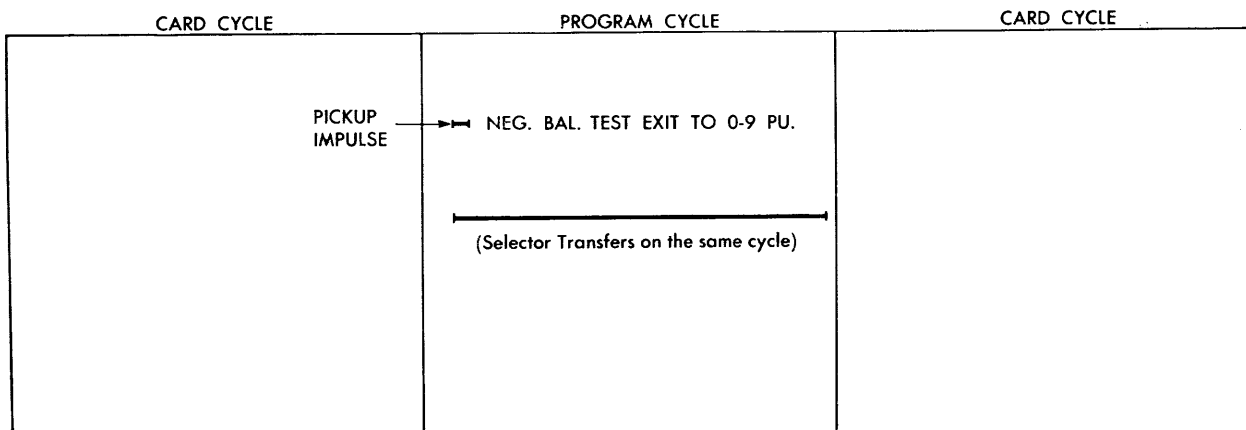
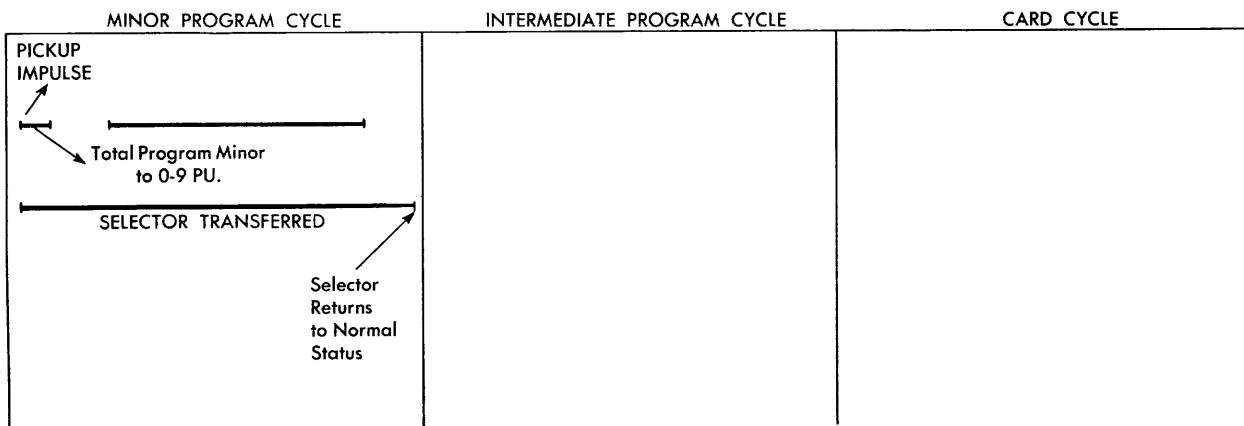
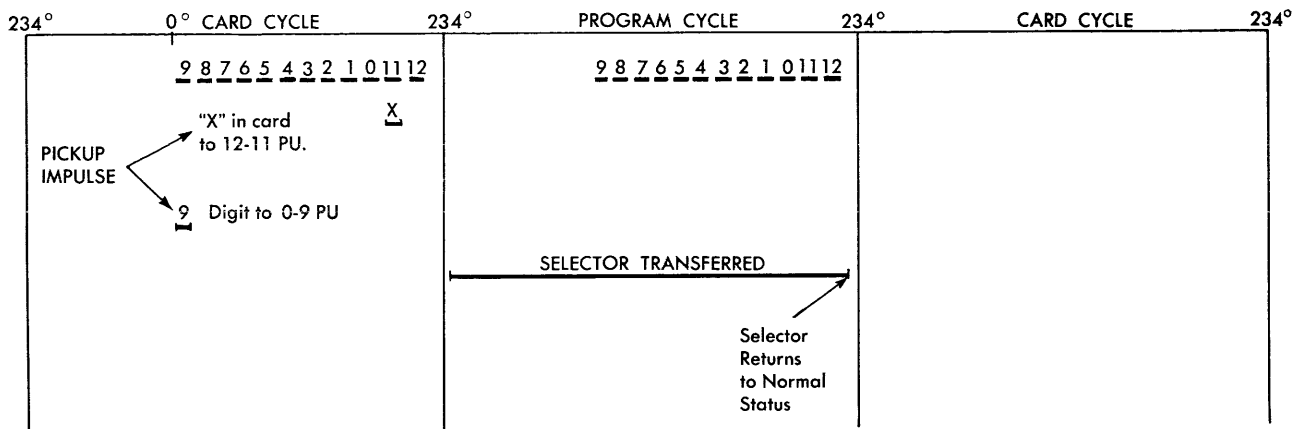
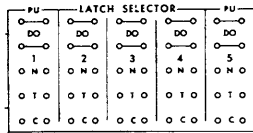

FIGURE 52. PILOT SELECTORS 1-60

Individual pickup of the selectors is not affected by the grouping of selectors in this feature. Selectors must still be individually picked up, but they will not drop out until the card feed cycle following the pick-up impulse.

Figure 53 shows the operation of pilot selector 1 when the hold feature is in operation. Note that pilot selector 1 holds up through intervening program cycles until the end of the next card feed cycle. Also the hold feature has no effect on the pilot selector when card cycles follow card cycles.



AJ-AN, 43-52

Latch Selectors

Five LATCH SELECTORS are standard on the machine. Each latch selector is provided with pickup,

drop out, and the usual common, normal, and transferred hubs. Any impulse whatever that is available from an exit hub on the 412-418 control panel may be used to pick up or to drop out a latch selector. Both pickup and drop-out are immediate. Once picked up, a latch selector will remain transferred until its drop-out hub is impulsed. Even if the main line power switch is turned off, the latch selector will still remain transferred. Therefore, the dropout of a latch selector should always be impulsed before the beginning of a run.

The latch selector drop-out should be impulsed at a time when no current is flowing through the selector. Otherwise, the selector points of the latch selector will be damaged. The timing chart should be consulted to select a suitable time for dropping out the latch selector. If pilot or co-selectors are being picked up, the latch selector should be dropped out between 250° and 225°, when the holding circuit of a pilot or co-selector is operative.

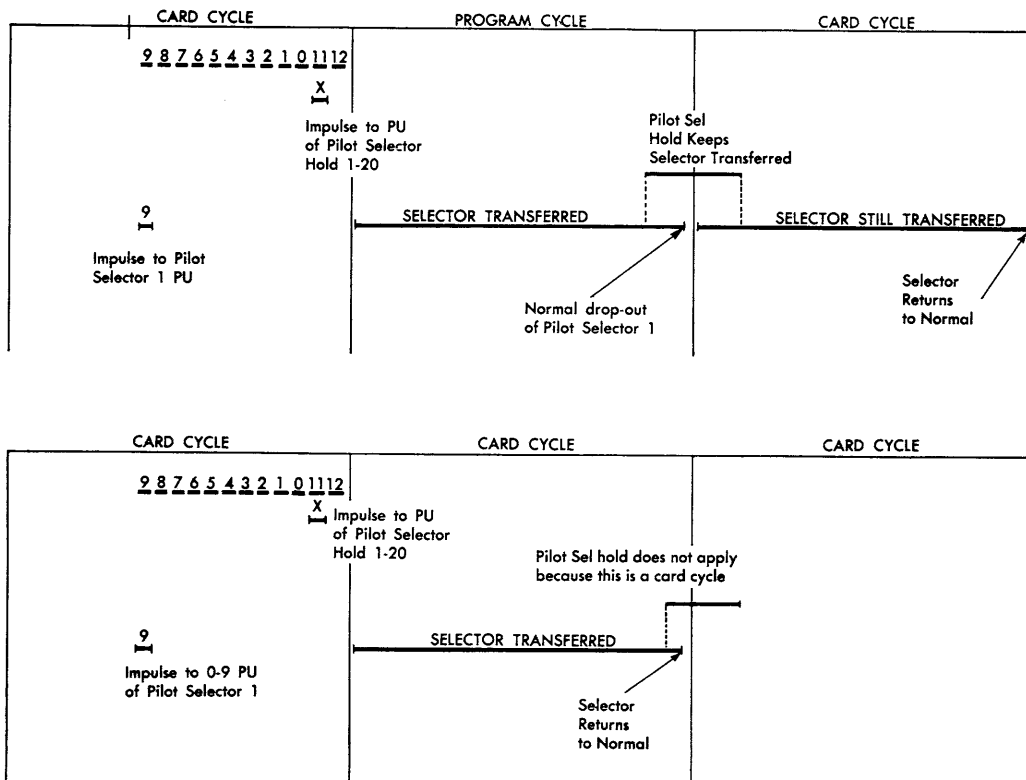

FIGURE 53. PILOT SELECTOR HOLD OPERATION

Calculator Selectors

The pickup hub of a calculator selector is an entry hub during a major portion of the accounting-machine cycle. Normally digits 0-9 from third reading are used, or second reading X- or 12-impulses are wired to a pilot selector, that is then used to control the calculator selector pickup. The calculator selector must not receive a pickup impulse after the start of calculate time (195°). *The latest impulse in the cycle that should be wired to the selector pickup is at O-digit time.*

The O-time pickup of calculator selectors provides the margin of safety required to allow the selection of program source wiring to program PU through the calculator selector (calculator control panel). A later

pickup of the calculator selector will damage the selector or fail to make program exits active on the early program steps, thus causing wrong calculations.

Calculator Selector Coupling Exit

The coupling exits should only be used to couple calculator selectors. If it is desired to pick up a calculator selector during calculate time to use it as an additional repeat selector, the following method is recommended. Program repeat, repeat delay, and repeat selector pickup would have been impulsed. Wire from program source to program source filter IN hub, and from the OUT hub through repeat selector points to the coupling exit of the calculator selector.

CALCULATOR CONTROL PANEL WIRING

ADDITIONAL PROGRAM STEPS

WHERE MORE than 60 program steps are needed, the calculator panel can be wired to provide as many as 180 program steps.

Figure 54 shows the basic wiring for this type of application. This example makes 120 program steps available. On the first 60 steps the A program exits are active. Program exits A 17 are wired to program repeat, repeat delay, and to repeat selector pickup. The program repeat function causes the calculator to begin program step 1 again after step 60 is finished. Thus the calculator will go through 120 program steps. The repeat delay function provides a pause between the end of step 60 and the beginning of step 1. During this pause or delay the repeat selector will transfer, and when calculation is resumed in step 1 the program source will activate a new set of program pickup hubs.

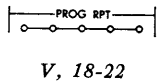

Program Repeat

There are five common PROGRAM REPEAT hubs on the machine. When these hubs receive an impulse from any program exit, the machine will go through another sweep of 60 program levels following the end of the program sweep during which program repeat was impulsed. The same program exits will be active on the second program sweep as were active on the first sweep, unless program repeat selectors are used to select other program exits.

Thus, the 605 will continue to calculate as long as the program continues to impulse PROGRAM REPEAT. Under such cases of continued calculation, the time required might overlap the time at which the 412-418 normally regains control to set up factors for the next calculation. The 412-418, however, recognizes the unfinished program, stops feeding cards, and waits until the calculating in the 605 is finished.

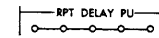

W, 18-22

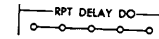

X, 18-22

Repeat Delay

Five common hubs are labeled REPEAT DELAY PICKUP. Five other common hubs are labeled REPEAT DELAY DROPOUT. When the repeat delay pickup hubs receive an impulse from any program exit, the machine will thereafter (until repeat delay is dropped out) pause for a period of time between the end of a program sweep and the beginning of a program repeat. The purpose of this delay is to allow time for program repeat selectors to pick up (or to drop out) before the beginning of the next program sweep. Repeat delay can be dropped out by impulsing any one of the repeat delay drop-out hubs from a program exit. Repeat delay drops out automatically when a new card feeds in the 412-418.

Repeat delay is used only in conjunction with program repeat and only when program repeat selectors are used. If repeat delay is needed at one part of a calculation in order to transfer selectors, but at a later time in the course of the calculation it is desired to take a program repeat without transferring any selectors (e. g., on an iterative operation); arrange the programming on the 605 so that repeat delay is dropped out in time to prevent needless delay of the calculator.

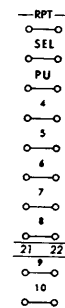

Y-AH, 21-22

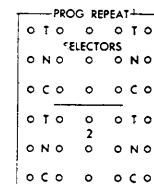

K-AN, 13-17

Program Repeat Selectors

Ten five-position PROGRAM REPEAT selectors are standard on the machine. The selectors have the usual common, normal, and transferred (C, N, and T)

hubs. Note, however, that the arrangement of the N and T hubs is not the same as that for the pilot and co-selectors on the 412-418 control panel. A program repeat selector is transferred by impulsing its pickup hub from any active program exit. The repeat selector will transfer after the end of the program sweep during which it was picked up, provided both program repeat and repeat delay pickup have also been impulsed during this program sweep. It is essential that both program repeat and repeat delay be picked up; otherwise, the repeat selector will not function. Repeat delay is necessary to provide time for selectors to transfer before beginning the next sweep of 60 programs. Once transferred, the repeat selectors will remain transferred until the end of the next sweep of 60 programs, at which time they will drop out automatically, provided they have not been picked up again, and provided repeat delay is operative. If, however, repeat delay is dropped out before the end of the next program sweep, the repeat selector will remain transferred until the next card feeds or until the end of the first program sweep after repeat delay is picked up again.

Program repeat selectors are normally used to select PROGRAM PICKUP wiring, and thus determine which program exits will be active during the next program sweep. The repeat selectors lend great flexibility to

the programming of calculations on the 605. Through their use, a calculation programmed on any series (A, B, or C) of program exits can be made either to precede or to follow another calculation that is programmed on any other series of program exits.

Wiring (Figure 54)

1. PROGRAM EXIT is wired to the common of REPEAT SELECTOR 1.
2. The normal of REPEAT SELECTOR 1 is wired to PROGRAM PICKUP A. This activates the A-program exits on the first program sweep.
3. PROGRAM EXIT A17 is wired to PROGRAM REPEAT. This will cause the program unit to return to step 1 after step 60 and prevent a program-end operation.
4. REPEAT DELAY PU is wired from PROGRAM EXIT A17 to cause a delay period after step 60 and before the program repeat function returns the program unit to step 1.
5. REPEAT SELECTOR 1 PU is also wired from PROGRAM EXIT A17. The selector will transfer during the repeat delay period.
6. PROGRAM PU B is wired from the transferred side of REPEAT SELECTOR 1.
7. REPEAT DELAY DROPOUT is wired from PROGRAM EXIT B1.

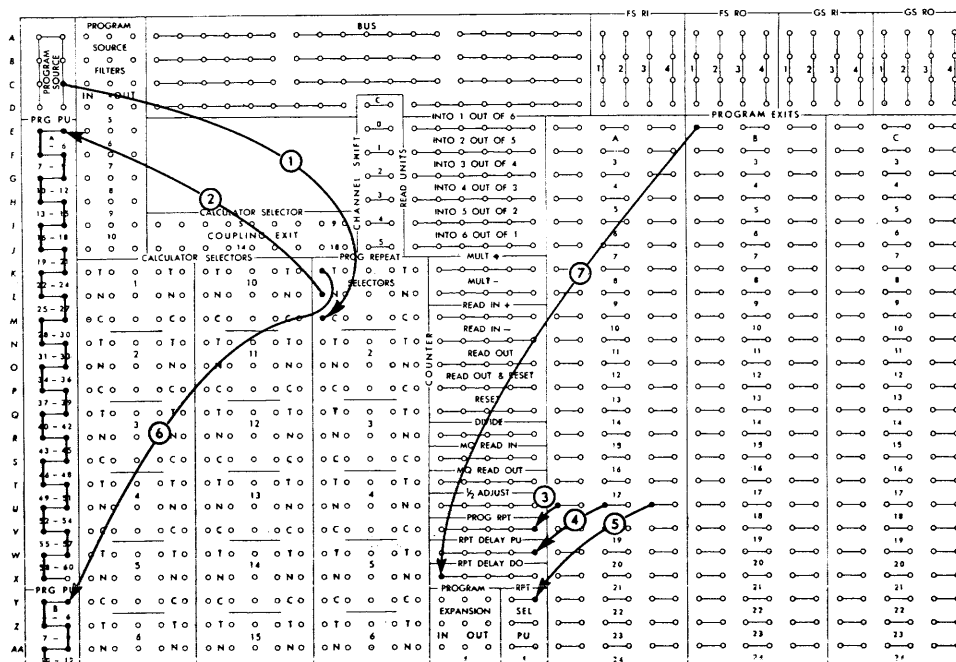

FIGURE 54. 120 PROGRAM STEPS

**Wiring for 180 Program Steps
(Figure 55)**

This wiring follows the same pattern as the wiring for 120 program steps. The sequence of operations that activates all the program exits is outlined as follows:

1. Program steps 1-60 (A exits)
 - pick up program repeat
 - pick up repeat delay
 - pick up repeat selector 1
2. First Repeat Delay period
 - repeat selector 1 transfers during delay period
3. Program steps 61-120 (B exits)
 - pick up program repeat
 - pick up repeat selector 2
4. Second repeat delay period
 - drop out repeat selector 1
 - transfer repeat selector 2
5. Program steps 121 to 180 (C exits)
 - drop out repeat delay

Note that REPEAT DELAY was picked up on the first sweep and not dropped out until the third sweep.

This, in conjunction with PROGRAM REPEAT PICKUP, caused the delay period to occur also after the second program sweep.

In this application the A PROGRAM EXITS were used on the first sweep, the B EXITS on the second sweep, and the C PROGRAM EXITS on the third sweep. In practice these program exits will not have to follow such a fixed pattern but will be intermixed on the various program sweeps.

Wiring (Figure 55)

1. This wiring sets up the second sweep and was described in Figure 52.
2. PROGRAM REPEAT is impulsed on step 1, B EXITS (second sweep, step 61).
3. REPEAT SELECTOR 2 PU is wired from PROGRAM EXIT B1.
4. The PROGRAM SOURCE impulse from the normal side of REPEAT SELECTOR 1 through the transferred side of REPEAT SELECTOR 2 to PROGRAM PICKUP C. This activates the C EXITS on the third program sweep.
5. REPEAT DELAY dropout is wired from PROGRAM EXIT C1.

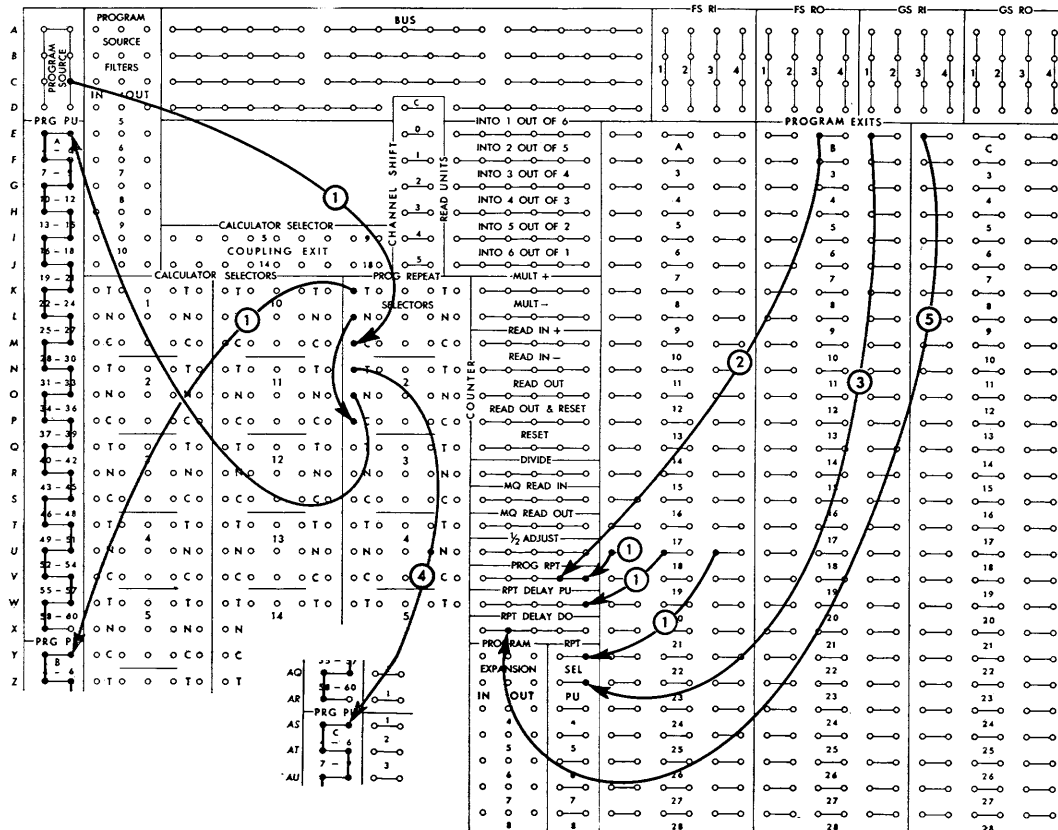

FIGURE 55. 180 PROGRAM STEPS

PROGRAM SOURCE FILTERS

TEN PROGRAM SOURCE FILTERS are standard on the 605. Each filter has an IN hub and two OUT hubs on the control panel. When a program source impulse is wired to the IN hub of any program source filter, the impulse is available at the two OUT hubs simultaneously. Program source filters have the property of offering low resistance to electrical conduction in the direction from IN to OUT, and high resistance in the direction from

OUT to IN. Thus, in effect, the impulses from the two OUT hubs are electrically independent.

Program source filters are normally used to eliminate back circuits when it is desired to activate either of two program pickups, separately under one set of

conditions and together under other conditions. In Figure 56, when calculator selector 1 is transferred and calculator selectors 2 and 3 are normal, program exits 16 to 24, 28 to 30, and 37 to 39 are all picked up. If calculator selector 3 is normal and 2 is transferred, only programs 28 to 30 are active, because the program source impulse cannot back up between the hubs of program source filter 10. Similarly, if calculator selector 3 is transferred, only programs 37 to 39 are picked up.

The program source filters are designed for use only in selector pickup circuits. They may not be used in electronic circuits. In particular, they must not be used for expanding program exits or for wiring to any program suppression hubs. The program source filters may, however, be used in wiring from the coupling exits of calculator selectors and in wiring for the selection of storage assignment.

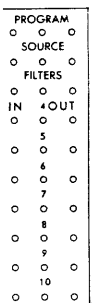

A-J, 3-5

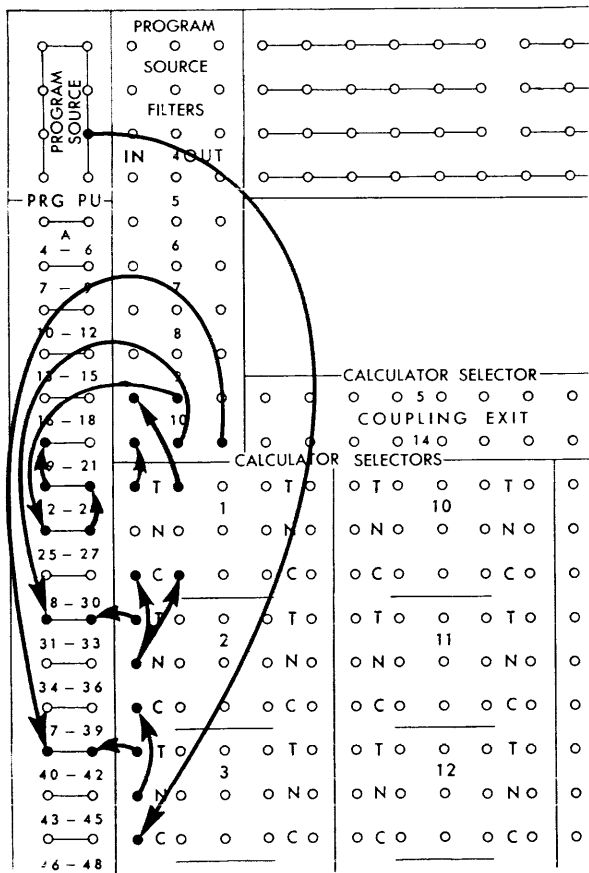

PROGRAM		SUPPRESSION		ENTRY	
1	21	1	21	1	21
2	22	2	22	2	22
3	23	3	23	3	23
4	24	4	24	4	24
5	25	5	25	5	25
6	26	6	26	6	26
7	27	7	27	7	27
8	28	8	28	8	28
9	29	9	29	9	29
10	30	10	30	10	30
11	31	11	31	11	31
12	32	12	32	12	32
13	33	13	33	13	33
14	34	14	34	14	34
15	35	15	35	15	35
16	36	16	36	16	36
17	37	17	37	17	37
18	38	18	38	18	38
19	39	19	39	19	39
20	40	20	40	20	40
21	41	21	41	21	41
22	42	22	42	22	42
23	43	23	43	23	43
24	44	24	44	24	44
25	45	25	45	25	45
26	46	26	46	26	46
27	47	27	47	27	47
28	48	28	48	28	48

AS-BL, 3-20

PROGRAM STEP SUPPRESSION

PROGRAM STEPS are made active in groups of 3 steps by PROGRAM SOURCE and PROGRAM PICKUP operation. Individual program steps may be suppressed in each of the A, B or C series by wiring to the SUPPRESSION ENTRY hubs. Electronic impulses that may be wired to suppression entry are: SUP NO TEST, SUP ON+, SUP ON-, SUP ON ZERO, SUP ON NON-ZERO, GROUP SUP EXIT or SUPPRESSION FILTER OUT.

An example of program suppression wiring is shown in Figure 57. This illustration also shows the use of suppression filters.

FIGURE 56. USE OF PROGRAM SOURCE FILTERS

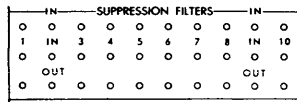

AL-AN, 3-12

SUPPRESSION FILTERS

TEN SUPPRESSION FILTERS are standard on the Type 605. Each filter has two IN hubs and one OUT hub. When a program suppression impulse is wired to either IN of a suppression filter, the impulse is available at the OUT hub. Suppression filters have the property of offering low resistance to electrical conduction in the direction from IN to OUT and high resistance in the direction from OUT to IN. Thus, in effect, the two IN hubs are electrically independent, and two different suppression impulses may be wired to the IN hubs without any back circuits resulting.

Suppression filters are normally used to eliminate back circuits when it is desired to suppress the same program level with either one of two suppression impulses. The suppression filters are designed for use only in electronic circuits. They will not withstand the higher currents in selector pickup circuits. In particular, suppression filters MUST NOT be used in any wiring involving PROGRAM PICKUP, STORAGE ASSIGNMENT, or the COUPLING EXITS of CALCULATOR SELECTORS.

Figure 57 shows the suppression filters suppressing an individual program step.

Wiring (Figure 57)

1. SUP ON+ is wired to SUPPRESSION FILTER 1 IN hub.
2. SUP ON ZERO is wired to the other IN hub of SUPPRESSION FILTER 1. (The zero test feature is explained in another section of the manual.)
3. The OUT hub emits the suppression impulse when either the SUP ON + or SUP ON ZERO hubs are active. It is wired to PROGRAM SUPPRESSION ENTRY B22 to suppress the B EXITS of step 22.

GROUP SUPPRESSION

MANY APPLICATIONS require that several balance tests be made in the course of a problem; for example, calculating FICA in a payroll application. The second balance test drops out the SUP ON + OR - status

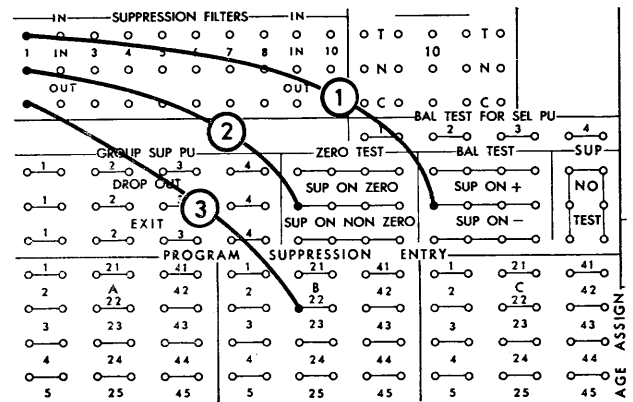
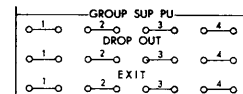

FIGURE 57. PROGRAM STEP SUPPRESSION

that was the result of the first balance test. The result of the first balance test may be remembered, and used to control program steps beyond the step where the second test is made by using GROUP SUPPRESS units. The GROUP SUPPRESS units have a PICKUP, a DROPOUT, and an EXIT hub. The application of group suppress units to suppress program steps beyond a second balance test is shown in Figure 58.



AP-AR, 3-10

Four group suppression units are standard on the machine. Each unit has two common PICKUP hubs, two common DROPOUT hubs, and two common EXIT hubs. Any group suppression unit may be picked up from any program exit. The pickup is immediate. On the next program step after it is picked up, a program suppression impulse is available at the exit hubs of the unit. The exit hubs will continue to supply program suppression for use on all succeeding program steps until either the drop-out hub is impulsed from a program exit, or until another card feeds in the 412-418. When impulsed from a program exit, the dropout becomes effective on the succeeding program step.

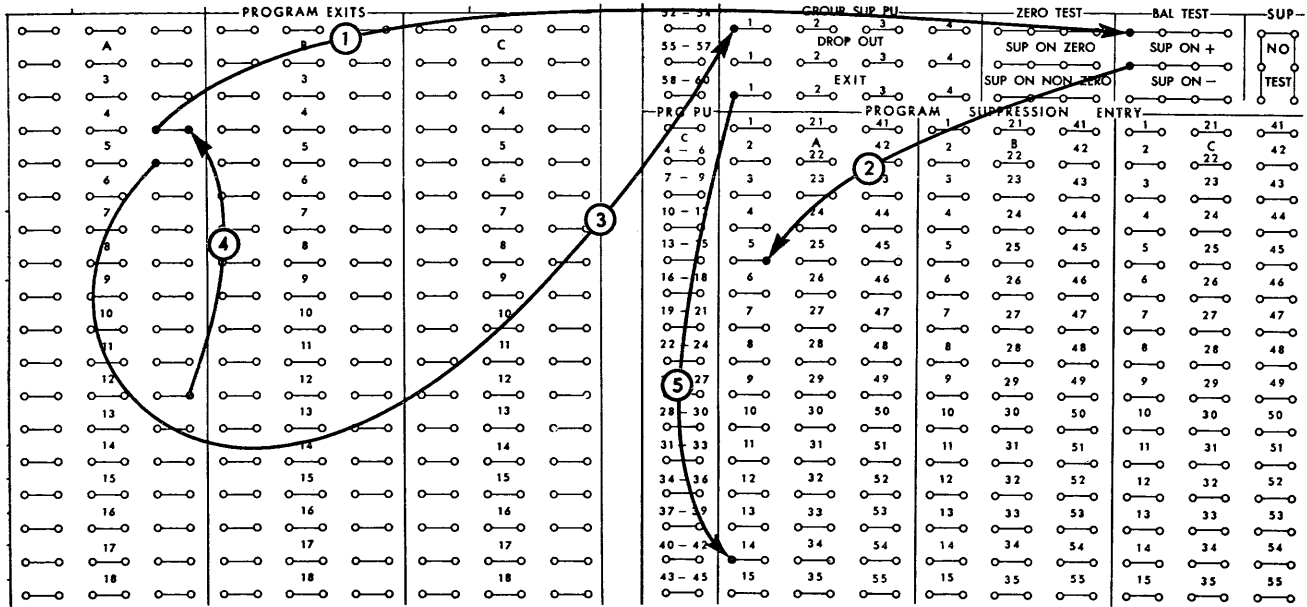
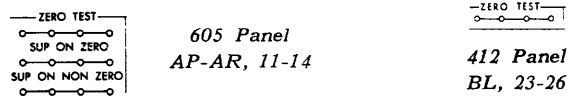

FIGURE 58. GROUP SUPPRESS WIRING

Wiring (Figure 58)

1. PROGRAM EXIT A4 is wired to BALANCE TEST.
2. Program exits A5 will be active only if the counter balance is minus on step 4. Program step 5 is suppressed by wiring from SUP. ON + to SUPPRESSION ENTRY A5.
3. PROGRAM EXIT A5 is wired to GROUP SUP 1 PU. Thus, group suppress 1 will be picked up if the counter balance was minus on step 4.
4. PROGRAM EXIT A12 is chain wired to BALANCE TEST.
5. GROUP SUPPRESS EXIT wiring to SUPPRESSION ENTRY 14, suppresses step 14. Thus the result of the balance test on step 4 controlled step 14 even though another balance test was made on step 12.

not on the punch panel as they were on the Type 604. The double exit hub for each storage unit emits an impulse identical to the PROGRAM SOURCE impulse. Therefore storage assignment hubs can be selected through repeat selectors to change the assignment for a program sweep following a repeat delay period.



ZERO TEST

FOUR COMMON ZERO TEST hubs are located at AP, 11-14 on the control panel. Directly beneath them are four common hubs labeled SUPPRESS ON ZERO and four other common hubs labeled SUPPRESS ON NON-ZERO. On the next program level, after a zero-test hub receives an impulse from a program exit, either the suppress on zero or the suppress on non-zero hubs will supply a program suppression impulse, according to whether the number standing in the electronic counter is zero or non-zero. Thereafter, the suppression hubs will continue to emit until the next zero test is made, or until another card feeds in the 412-418. Zero test on the 605 does not reset the counter automatically. However, zero test and counter reset may be impulsed simultaneously on the same program level.

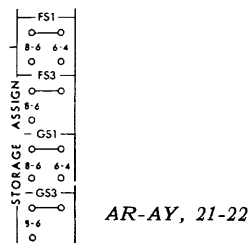

STORAGE ASSIGNMENT

STORAGE ASSIGNMENT wiring on the Type 605 is similar to wiring on the Type 604. However, the assignment hubs are on the calculator control panel and

When any positive number standing in the Type 605 counter is zero tested, the number is increased by one in the position where units are read into. A negative number in the counter is not altered by zero testing in the units position. A negative number is altered by zero testing in other than the units position. A typical commercial application is the zero balancing of a calculated result against a previously calculated amount to check the result. Engineering calculations use the zero test to determine when an iterative operation is to be terminated.

Certain number combinations cause the electronic counter to contain either a positive or a negative zero balance. Examples of a positive zero balance and a negative zero balance follow. These examples show a recalculated result (that still contains the half adjust position) being zero balanced against the original calculated result.

Positive Zero Balance

97483 ← Calculated result in counter = 2.51
 and a 6 in the half adjust position.
 -251 ← Previous result is RI minus to arrive
 at zero balance
 99993 ← Positive zero balance
 ↑
 Zero Test

Negative Zero Balance

-2513 ← Multiply minus operation = -2.51
 997489 ← Previous result is added to arrive at
 zero balance.
 000002 ← Negative zero balance
 ↑
 Zero Test

The zero test feature will recognize either a positive (all 9's) or a negative (all zeros) zero and make the SUP ON ZERO hubs active. A non-zero result causes the SUP ON NON-ZERO hub to emit. A non-zero condition also causes the ZERO TEST hubs on the 412 panel (BL, 23-26) to emit a 10 impulse on the next machine cycle. Figure 59 shows the basic wiring for a zero test and program suppression as a result of the test.

Wiring (Figure 59)

1. PROGRAM EXIT A5 is wired to ZERO TEST. This wiring causes the counter to be tested for a positive or negative zero on program step 5.

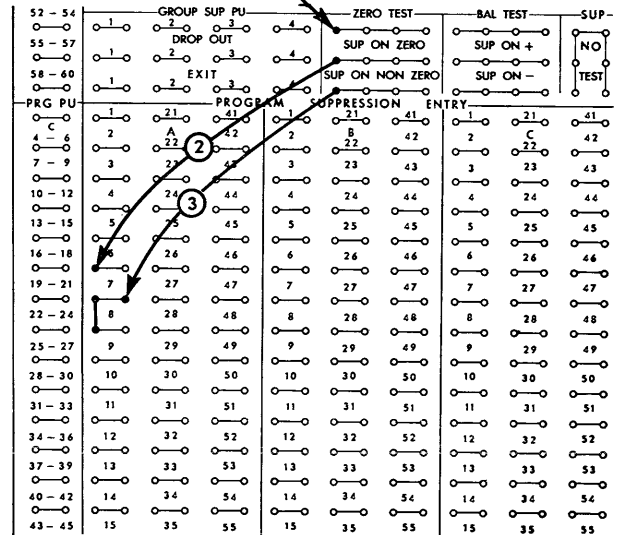
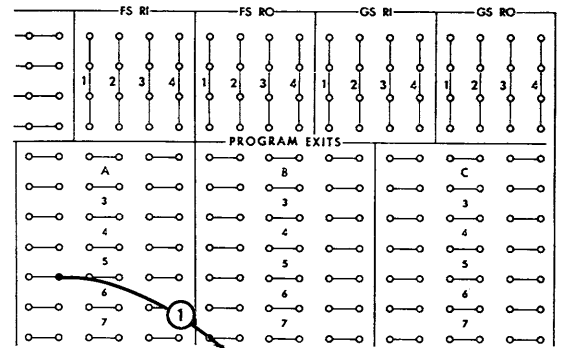

FIGURE 59. ZERO TEST WIRING FOR SUPPRESSION

2. This wiring suppresses the A EXITS for program step 6 if the counter contained a zero balance on step 5.

3. SUP ON NON-ZERO TO PROGRAM SUPPRESSION A7 AND A8 suppresses the A EXITS for program steps 7 and 8 if the counter balance was not zero on step 5.

Number Combinations Affecting Zero Test

The previous examples of a positive and a negative zero balance contain an undropped decimal to the right of the zero test position. This undropped decimal, in certain number combinations, will cause a false zero condition when actually a non-zero condition is in the counter. This is illustrated, by the following example which shows that, if the machine calculated the original result 1 high and the recalculated result correctly, the zero test should indicate a non-zero condition, but because of the 1/2 adjust position and this combination of numbers an incorrect zero condition appears.

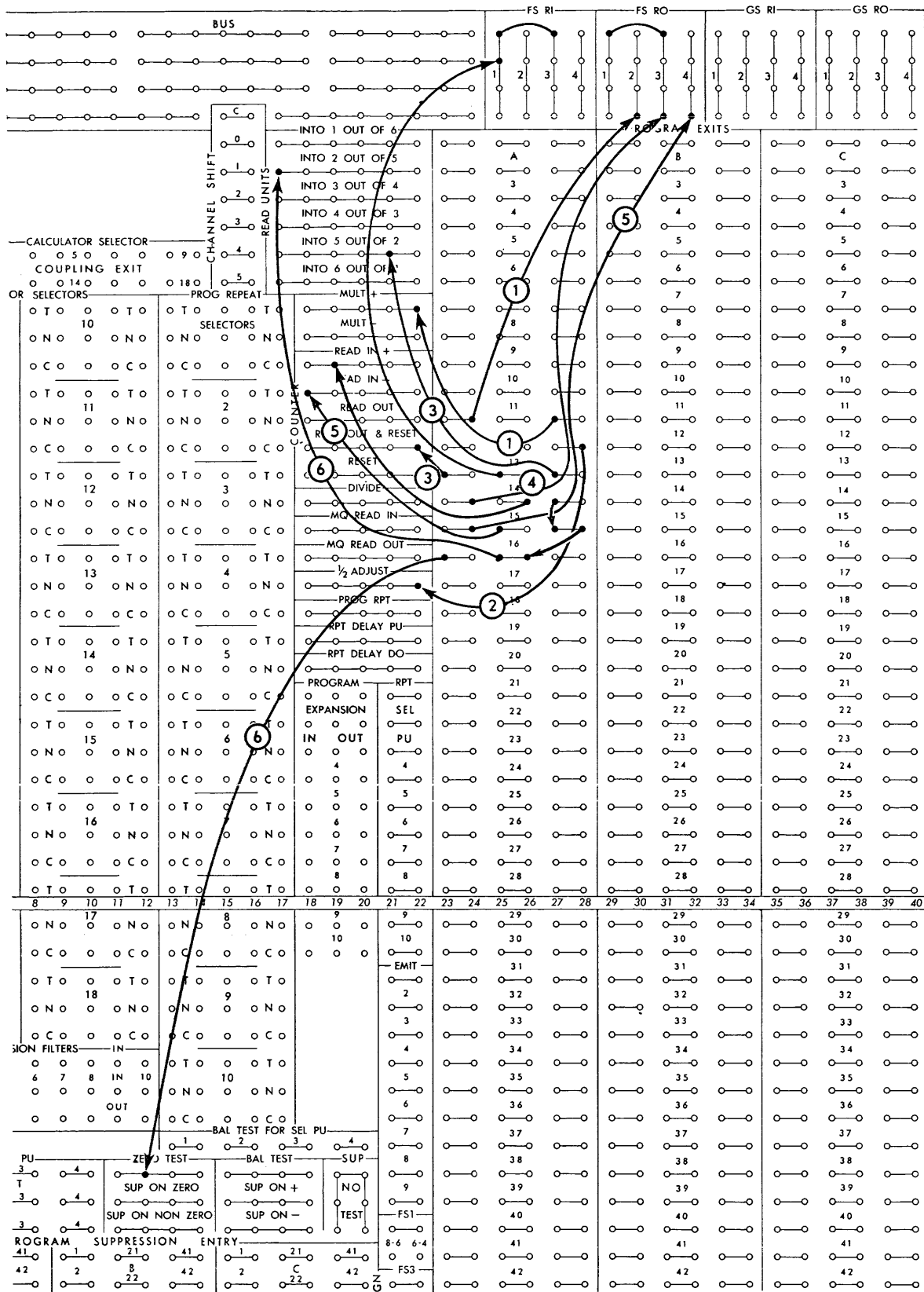

FIGURE 60. ZERO TEST FOLLOWING A MULTIPLY CHECK

97483 ← Recalculated result in counter =
 +2.51 (correct)
 -252 ← Previous incorrect result is RI minus
 to try for a zero balance
 00004 ← Balance is a negative zero (due to
 ↑ first result being "one" high).
 Zero test would indicate a negative zero, which is
incorrect.

Therefore a zero test should be made only when previous programming has eliminated extraneous digits to the right of the zero test position. The following example shows a correct zero test using the same factors after the extraneous digits to the right of the zero test position have been eliminated by programming.

97489 ← Recalculated (correct result)
 -252 ← Previous incorrect result is RI minus
 00010 ← Result is non-zero (Note carry back
 ↑ from high-order position puts 1 in
 the tens position of counter)
 Zero test indicates Non-Zero (Correct indication)

The wiring for a zero test following a multiply check operation that includes 1/2 adjusting is shown on Figure 60.

Wiring (Figure 60)

1. Program step 11 shows the wiring for a multiply operation where the multiplicand is in FS2.
2. The product is half-adjusted on step 12.
3. PROGRAM EXITS A13 cause the COUNTER TO READ-OUT AND RESET into FS1 AND 3. READ UNITS OUT OF 2 is wired, which drops the 1/2 adjust position.
4. FACTOR STORAGE 1 AND 3 READ OUT and the COUNTER READS IN + on step 14.
5. The original calculated result was stored in FS4. PROGRAM EXIT A15 causes FS4 to read-out and the COUNTER TO READ-IN MINUS.
6. The ZERO TEST is made in the second position of the counter by wiring from PROGRAM EXITS A16 to ZERO TEST and to READ UNITS INTO 2.

PAYROLL APPLICATION

THE CPC brings a new concept and fresh approach to commercial applications that has proved in many cases to be more efficient and economical than conventional machine methods. It is essentially an accounting machine and a calculator combined into one integrated unit. The combination provides greater capacity and flexibility than all of the components possess as individual units.

As an example of this new approach, CPC payroll applications are not only performing the calculations and printing the report, but also recalculating and checking computations in one run of the cards through the machine. This data processing concept sets up a routine for each group of cards to follow. The complete routine is then set up in one machine. Former methods have utilized a series of smaller capacity machines in sequence to accomplish the same application. Since the data processing method reduces operating steps it must also incorporate a system of checking the output results.

The following payroll application prepares the paycheck and register simultaneously. A dual feed carriage is used which allows the paycheck and earnings statement to be printed as the original document and the register as a carbon copy. Calculations for gross pay and net pay are made and recalculated to prove their accuracy. Each factor contributing to gross pay and net pay is read at both reading stations in the machine. Separate machine setups are provided for the original calculations and the recalculated amounts.

Figure 61 shows a sample pay check, earnings statement, and payroll register. There are two lines printed for each employee. The spacing between the two lines on the pay check is different from the register spacing and each is controlled by its respective carriage. Note that the columns on the payroll register have two headings. The upper heading represents the amount printed on the upper line for each employee; the lower heading describes the amount printed on the second line.

Among the many advantages of using a CPC for this application are:

1. One machine (CPC) performs the calculating, checking, printing, and summary punching. This condenses a number of operations into one CPC operation.

2. Reduction of work flow and card handling.
3. The data for each employee is completely processed in one machine operation. This simplifies blocking of work and eases deadlines. Terminations and special pay checks can be written at any time.
4. Payroll can be processed a department at a time. If a discrepancy develops, a whole department can be held out for investigation while the remaining departments are processed without delay.
5. Average time per employee to write the pay check and register is 4 seconds. This includes summary punching one card for each employee.
6. Necessary calculations are made and checked in one run of the cards through the machine. A discrepancy between the original and check calculation stops the machine at the end of that employee's cards.

Notice particularly the payroll variations that are shown on the register (Figure 61).

1. The first employee (A. B Jones) illustrates overtime and FICA tax of \$1.00. His FICA YTD amount (summary punched only) reached \$72.00 this week.
2. The second employee had only 3 cards (name, current earnings, and YTD card). He did not have other deduction cards in his payroll.
3. An asterisk is printed next to the "total other deductions" amount of the third employee. This indicates that an "other deduction" card with an amount punched greater than net pay amount is included in his deck but was not subtracted.
4. The fourth employee has a tax class code of 8 and therefore no withholding tax is deducted.
5. The last employee's pay does not include incentive or other earnings.

Figure 62 shows the various types of cards used to prepare this payroll.

- Name Card (Code 1 in column 80)
- Other Earnings (Code 2 in column 80)
- Current earnings (Code 3 in column 80)
- Year-to-date summary (Code 4 in column 80)
- Deduction card (Code 5 in column 80)

PAYROLL REGISTER													
Employee Number	Employee Name	Date	Net Pay	Regular Hours	O.T. Hours	Hourly Rate	Base Earnings	Overtime Premium	Gross Pay	Tax Cl.	Social Security No.	With. Tax Yr. to Date	
				Net Pay	Incentive other Earn	FICA Tax	Withhold. Tax	Total other Deductions	Gross Earnings Year to Date				
12345	A B JONES	5155-	09781	460	60	1720	7912	755	12333	2	73015412	54706	
23456	T A JONSON	5155-	08709	400		1720	6880		9423	5	73015377	21492	
34567	A E JOHNSON	5155-	04253	200		1720	3440		5606	2	73015412	53495	
45678	K M DAVIS	5155-	07817	400		1720	6880		8499	8	73016882	9658	
56789	W H HICKEY	5155-	04493	400		1440	5760		5760	3	107165382	64719	

GENERAL MANUFACTURING COMPANY NEW YORK, NEW YORK To the Order of				GENERAL MANUFACTURING COMPANY DETACH AND RETAIN THIS STUB AS YOUR RECORD OF EARNINGS AND DEDUCTIONS									
12345 Employee Number	A B JONES	5155- Mo Day Yr Date		460 Reg. Hours	60 O.T. Hours	1720 Hourly Rate	7912 Base Earnings	755 Overtime Premium	12333 Gross Pay	2 Tax Cl.	73015412 Social Security No.		
STANDARD BANK AND TRUST CO. New York, New York			PAY \$ 09781 Dollars & Cts.	09781 Net Pay	3666 Incentive other Earn			100 FICA Tax	1752 Withhold. Tax	700 Total other Deduction		367595 Gross Earnings Year to Date	54706 With. Tax Yr. to Date
Authorized Signature													

FIGURE 61. PAYROLL CHECK AND REGISTER

A minimum of three cards are required for each employee. The necessary three cards are: a name card, a current earnings card, and a year-to-date summary card. He may also have any number of "other earnings" cards or deduction cards.

This flexibility lends itself to a variety of payroll applications. For example: the other earnings and current earnings card operation can be modified from this application to represent daily earnings cards. The last daily earnings card of the week would follow the current earnings card (code 3) pattern of this application. The other daily earnings cards would follow the pattern of the "other earnings" cards (code 2) in this application.

A new year-to-date card is summary punched for each employee and it is used in the following weeks payroll.

The calculations required for this payroll application are:

- Regular hours × Hourly rate = Base earnings
- $$\left(\frac{\text{Base} + \text{Other earnings} + \text{Incentive earnings}}{2 \times \text{Regular hours}} \right) \times \text{Overtime hours} = \text{Overtime premium}$$
- Base + Other earnings + Incentive earnings + Overtime premium = Gross pay
- $[\text{Gross pay} - (\text{Tax class} \times \$13.00)] \times 18\% = \text{Withholding tax}$
- FICA, 2% of weekly gross up to a maximum of \$72.00 per year.
- Gross - Withholding tax - FICA - Deductions = Net pay
- Gross pay + Gross YTD = New gross YTD
- With tax + With tax YTD = New with tax YTD
- FICA + FICA YTD = New FICA YTD

FIGURE 62. PAYROLL APPLICATION CARD FORMS

Before a deduction is taken, a test is made to determine whether or not the remaining net pay is sufficient to cover the deduction. An asterisk is printed next to the total deduction amount on the earnings statement when deductions are not subtracted.

In checking these calculations, various techniques are used. Some of the checking is done in the calculator and some in the 412 counters and comparing unit. Two checking formulas are used. The first

one proves the original gross pay by recalculating its component amounts and zero balancing against the original gross. The second formula checks the net pay amount by zero balancing the original gross (which has been checked) against the sum of net pay and all deductions. All card fields are read at both the second and third reading stations. The original calculations are a result of fields read at second reading. The recalculations are from fields read at

third reading. Some card fields, such as other and incentive earnings, are checked in the 412 comparing unit.

The checking formulas are:

1. Gross (original)—other and incentive earnings (checked)
 —overtime bonus (recalculated) – base earnings (recalculated) = 0
2. Gross (original)—net pay (original) – deductions (checked)
 —withholding tax (recalculated) – FICA (recalculated) = 0

Thus gross, net pay, deductions, other earnings, taxes, base wages, and overtime bonus are all carefully checked for accuracy. The new gross YTD, withholding tax YTD and FICA YTD amounts may be checked on a separate run of the summary punched cards.

Even with these checking features, a considerable amount of machine capacity is available for still further refinements and variations. For example, 24 counter positions in the 412 are available, the field selector, 26 co-selectors, 52 pilot selectors, and 9 coding selectors have not been used. In the calculator, 75 program exits, calculator selectors, etc., are available for additional calculations. In addition to these 412 and 605 features all the storage registers of the 941 storage unit are also available. The 941 storage unit was not used in the preparation of this application.

This unused machine capacity can be used for such things as obtaining department totals on the register, crossfooting department totals by special programming or to provide for the payroll variations that are not included in this application.

PLANNING CHART

TO FACILITATE the development of an application to the CPC it is important to plan the entire job before attempting any control panel wiring. The planning chart used may take various forms depending on the application and the individual. Preliminary information needed is a description of the output requirements, the input information available from IBM cards and the formulas to be calculated. The chart should plan the card sequence and show the machine

cycle on which input information is available and when output results must be printed. The required calculations can then be planned to occur in the time available between the arrival of input data and when the output results are required.

The planning chart used on this application has as its basic unit a square block (Figure 63) which represents one card in one machine cycle, or one program cycle.

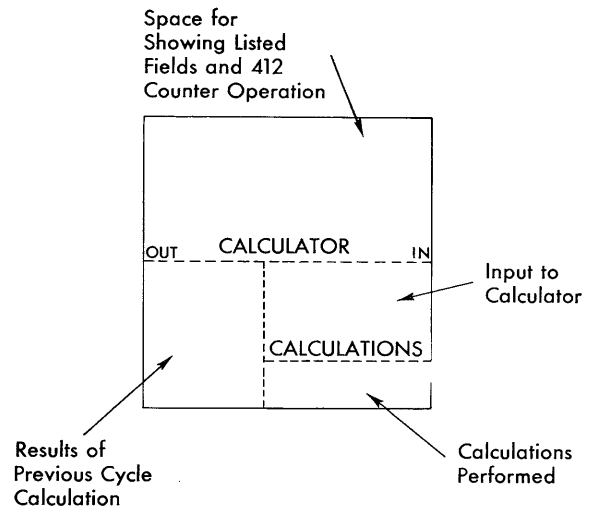

FIGURE 63. PLANNING CHART BLOCK

The upper half of each block shows the accounting machine operation such as the card fields that are listed or read into 412 counters. The lower half of each block shows calculator operation. The left half of the calculator section shows results readout of general storage or electronic counter. These results were derived from information read into the calculator on some previous cycle. The right half of the calculator section shows fields read into the calculator on that cycle from the card or from a 412 counter. The lower part of the right half of the calculator section shows the calculations programmed during calculate time of that cycle.

Two of these blocks placed side by side show the planning for one card (Figure 64). The left block shows action that occurs as the card passes second reading. The right block shows the card passing third reading. Thus Figure 64 shows the two machine cycles required to feed the card past the two reading stations in the machine.

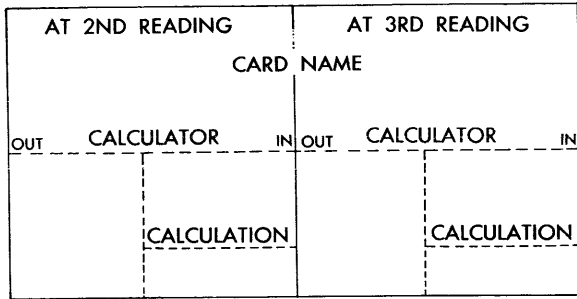

FIGURE 64. PLANNING CHART BLOCK FOR ONE CARD

Figure 65 shows card 1 followed by card 2. The planning chart blocks overlap to show that while card 1 is at third reading, card 2 is at second reading. Thus on cycle 2, input information from either card may be printed, or read into 412 counters, or into the calculator by selecting the field from the proper reading station.

Thus each row of planning chart blocks represents action pertaining to one card. Each column of blocks shows the action for one machine cycle.

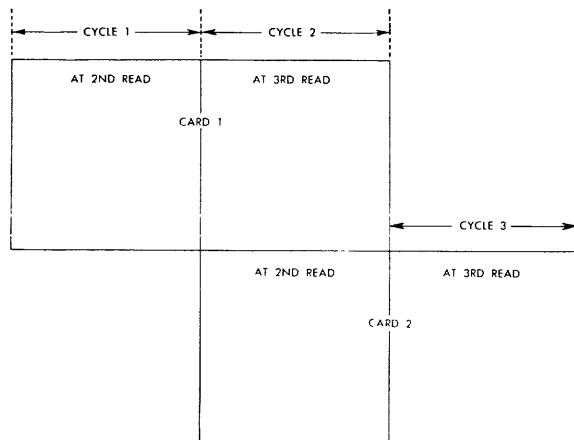

FIGURE 65. PLANNING CHART FOR 2 CARDS

CONTROL PANEL DIAGRAMS

THE CONTROL PANEL diagrams of section one show the wiring for calculating the results needed to print the pay check and register. All of the fields are wired through selectors before reading in or reading out of 605 storage and 412 counters. Many of the fields pass through several selectors in sequence and the reasons for this are not always apparent by looking at only one of the control panel diagrams. The full significance of the field selection can only be seen by considering all of the diagrams in section one and in section two.

A number of diagrams are used to show the wiring for section one. The second diagram (Figure 69) shows the pilot and co-selector pickups for the whole application including the selectors used in checking. The other diagrams (Figures 68, 70-79) show the wiring for events that occur in specific cycles of the planning chart. Figure 70 shows the wiring and planning for cycle 1, the next diagram for cycle 2, etc. Summary punch wiring is shown on Figure 78. Notice that by showing the planning and wiring for each cycle separately, the diagrams are simplified and the concept of the machine for the application is retained.

The unshaded areas of the 605 planning charts apply to the original calculations and are described in the section one text. The shaded areas show the planning for the checking calculations and are explained in the text of section two.

Several control panel features are used in this application which have not previously been described. A description of these follows.

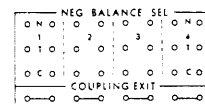

J-L, 57-64

Negative Balance Selector

One NEGATIVE BALANCE SELECTOR is standard, three more are optional. The selector pickup is on the 605 control panel and is wired from a PROGRAM EXIT. If the 605 counter balance is negative on the program step that BAL TEST FOR SEL PU is wired, the selector transfers. It will remain transferred for the following 412-418 machine cycle.



T, 43-45

Test

These three hubs are special stop hubs. The TEST hub accepts any digit impulse to cause the machine to stop. The CPC is restarted by depressing the final total key and then the start key.



527 Panel: EE-HH, 1-20

412 Counter Exits

Wiring of these hubs on the 527 punch control panel is similar to normal summary punch wiring.

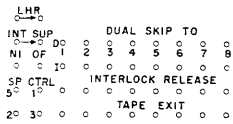

Location of the dual feed carriage hubs will vary between machines.

Dual Feed Tape Carriage

The dual feed carriage is a special device. It consists of two carriage tape drive mechanisms, one located at each end of the platen. The right drive unit controls the platen spacing. The left tape drive unit controls and operates the upper forms tractor and has no connection with the platen. In this application the left-hand carriage controls the pay-check spacing. The payroll register spacing is controlled by the right-hand carriage.

An additional set of carriage control panel hubs are provided. Each tape-drive unit may be connected to either set of control panel hubs. This connection is made by a flexible-cable connector located behind the carriages. In this application the left tape-drive unit

is connected to the standard carriage control panel hubs. The right tape-drive unit is connected to the auxiliary carriage control panel hubs. Control panel wiring is shown in Figures 70, 74, 79.

SECTION ONE: PAYROLL COMPUTATIONS

Two planning charts are shown for this application. Figure 66 shows the cycle by cycle sequence of operations for an employee whose net pay is developed from the following types of cards:

- 1 name card
- 1 current earnings card
- 1 year to date earnings card

This is the minimum number of cards an employee can have. Since 3 cards and one minor program cycle are involved, the planning chart shows four machine cycles. Note that cycle 1 shows the name card at the third read station and the following card (current earnings card) at second read station. Cycle 2 shows the current earnings card at third reading and the year to date card at second reading. Cycle 3 shows the year to date card at third reading and the name card of the next employee at second reading. The difference in employee number is recognized and a minor program cycle occurs (cycle 4). Compare the planning charts to the payroll check and register to associate the card input, calculations, and printed output.

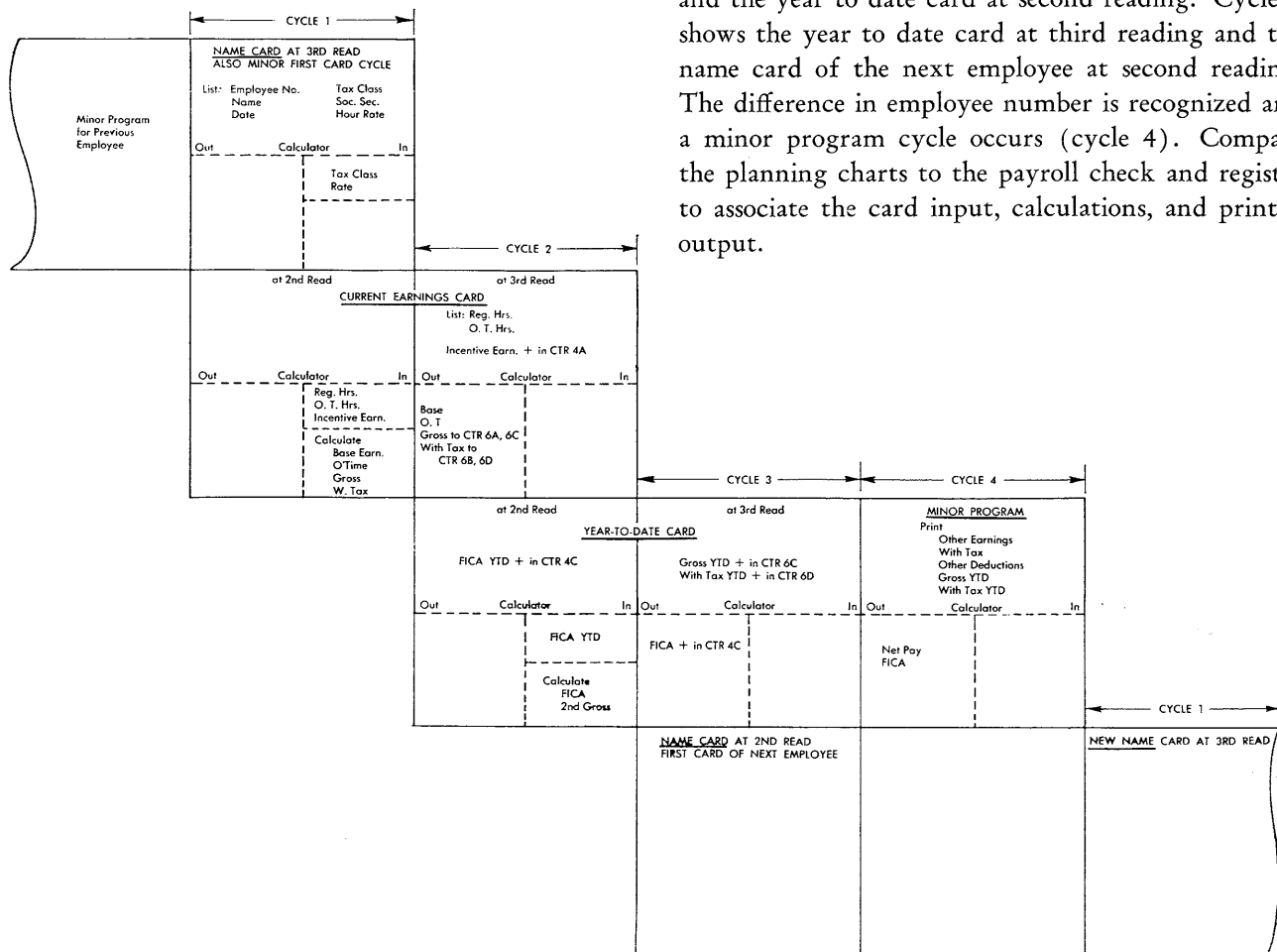
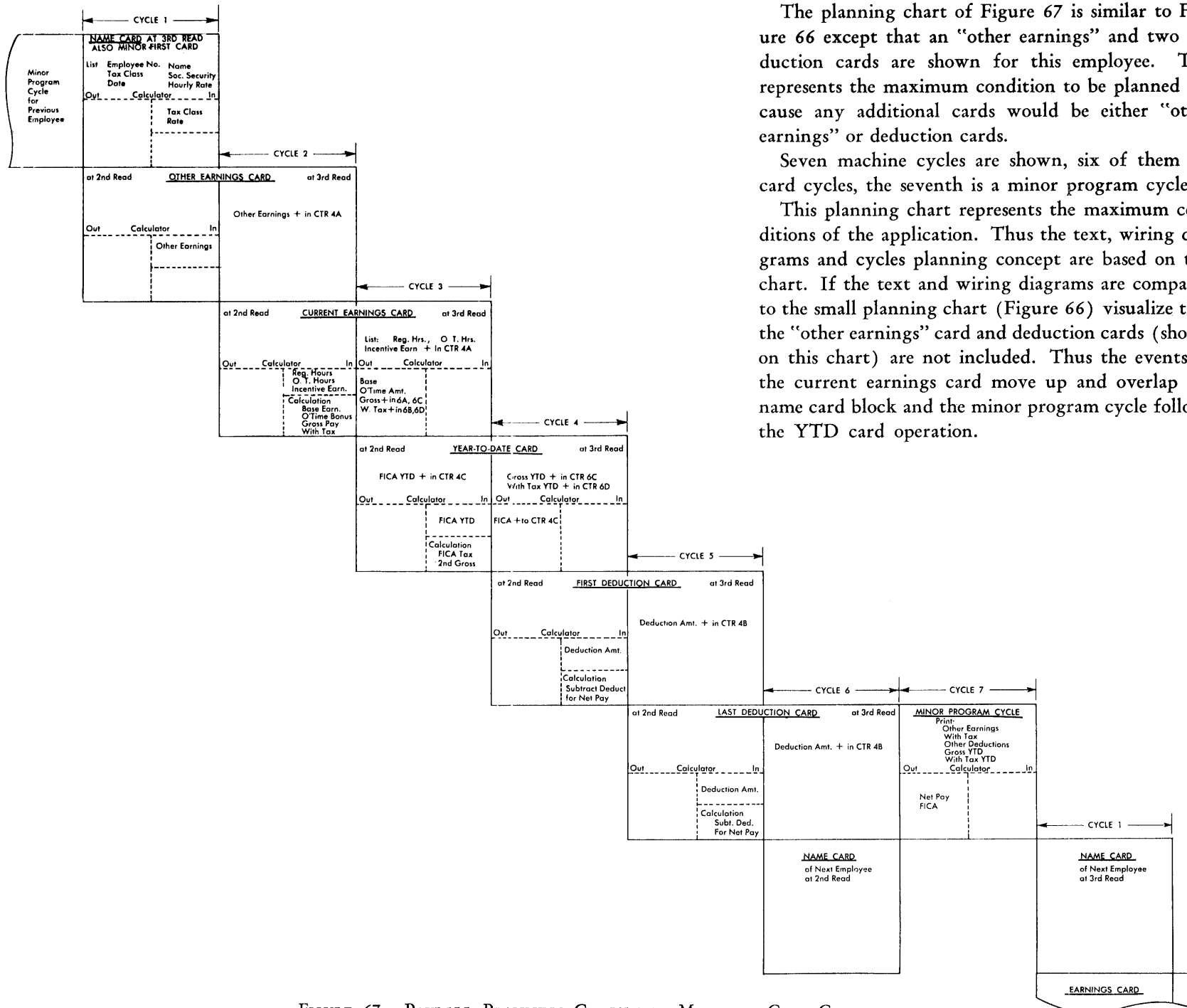

FIGURE 66. PAYROLL PLANNING CHART FOR MINIMUM CARD CONDITIONS



The planning chart of Figure 67 is similar to Figure 66 except that an "other earnings" and two deduction cards are shown for this employee. This represents the maximum condition to be planned because any additional cards would be either "other earnings" or deduction cards.

Seven machine cycles are shown, six of them are card cycles, the seventh is a minor program cycle.

This planning chart represents the maximum conditions of the application. Thus the text, wiring diagrams and cycles planning concept are based on this chart. If the text and wiring diagrams are compared to the small planning chart (Figure 66) visualize that the "other earnings" card and deduction cards (shown on this chart) are not included. Thus the events of the current earnings card move up and overlap the name card block and the minor program cycle follows the YTD card operation.

FIGURE 67. PAYROLL PLANNING CHART FOR MAXIMUM CARD CONDITIONS

Calculator Selector Wiring (Figure 68)

1. When CALCULATOR SELECTOR 1 is transferred PROGRAM EXITS A4-6 are active.
2. When CALCULATOR SELECTOR 2 is transferred PROGRAM EXITS A4-6 and A7-42 are active.
3. The transferred CALCULATOR SELECTOR 3 causes PROGRAM EXITS B1-60 to be active.
4. When CALCULATOR SELECTOR 4 is transferred PROGRAM EXITS A55-60 are active.
5. PROGRAM EXITS A1-3 are active when CALCULATOR SELECTOR 5 is transferred.

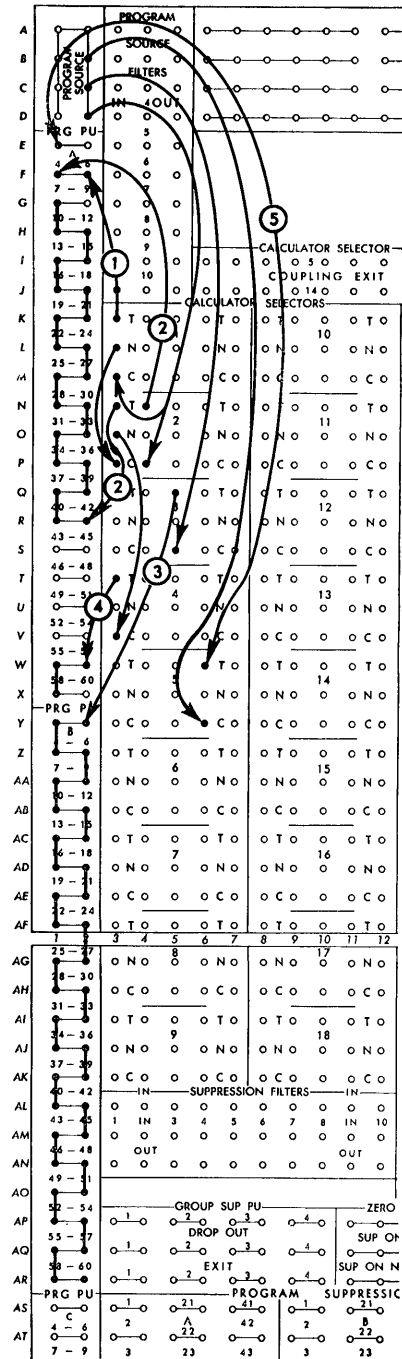

FIGURE 68. TYPE 605 SELECTOR DIAGRAM

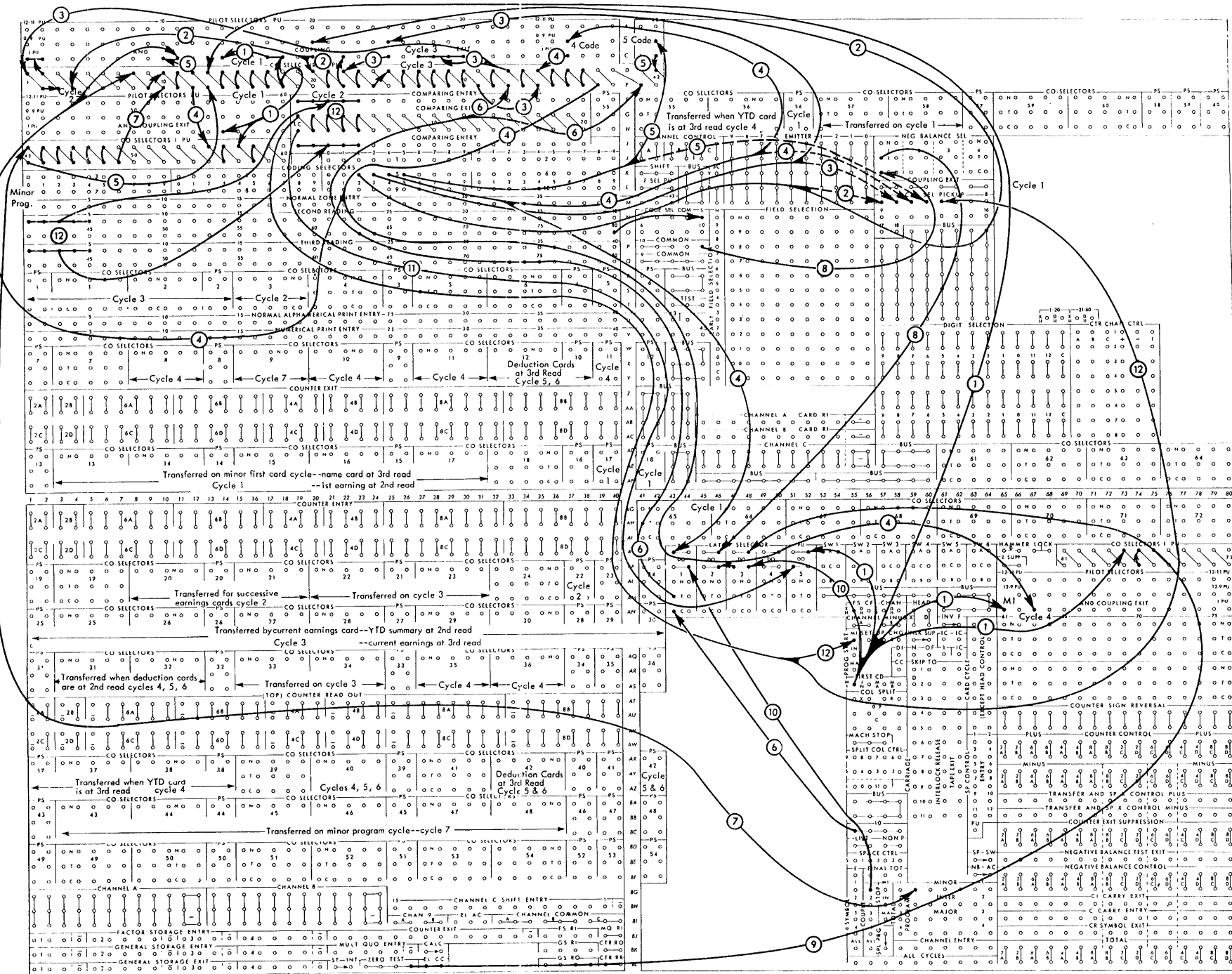

FIGURE 69. PILOT AND CO-SELECTOR PICKUP DIAGRAM

Selector Control (Figure 69)

For simplicity and logical arrangement all the selector pickup controls are combined on this one diagram. Also shown is the pickup wiring for selectors used in checking functions. The diagram shows the pickup of PILOT, LATCH, CALCULATOR, and CO-SELECTORS.

Labels have been placed on the pilot and co-selectors to further identify their function and time of use. These serve as a convenient reference for tracing selected fields on the other diagrams of this application.

In planning the selector controls for a CPC application the maximum and minimum number of cards per employee group must be taken into consideration. In this application an employee may have a variable number of earnings and deduction cards. This means that if fields are read at second reading, the selectors controlling these fields must be picked up by the previous card. The column 80 card code is the basis of this control.

The field selection for the variable number of earnings cards is handled by the operation of co-selectors 14, 15 and 20, 21 (Figures 70, 71). Calculator selector 1 provides for the accumulation of "other earnings" amounts.

Field selection for the variable number of deduction cards is controlled by latch selector 1 which is picked up by the YTD card. The transferred latch selector then causes the pickup of co-selectors 30, 31. The latch selector dropout hub is impulsed on the minor program cycle. Thus all cards following the YTD card and before the program cycle are considered deduction cards.

Each CPC application has its own selector

control requirements. Proper planning will assure the most efficient use of the available machine capacity in commercial applications.

WIRING

Note: Column 80 SECOND READING is wired to CODING SELECTOR 5 COMMON.

1. Cycle 1 Selectors: MINOR FIRST CARD impulse picks up CO-SELECTOR 13, 14, 15, 16, 17, 57, 58, 65, 66; PILOT SELECTORS: 14, 17, 18, 56, 61, and LATCH SELECTOR 5. These selectors are all transferred on cycle 1.
2. The 2 Code, from CODING SELECTOR 5, impulses the 0-9 pickup of PILOT SELECTOR 20 and CALCULATOR SELECTOR 1. The COUPLING EXIT of PILOT SELECTOR 20 emits to pickup CO-SELECTORS 3, 20, 21, and PILOT SELECTOR 22. These selectors are transferred when the "other earnings" card passes third reading.
3. The 3 code impulse from the CODING SELECTOR picks up CALCULATOR SELECTOR 2. It is also wired to the 0-9 PICKUP of PILOT SELECTOR 25. The COUPLING EXIT of PILOT SELECTOR 25 emits to pick CO-SELECTORS 1, 2, 22, 23, 25, 26, 27, 28, 29, 30, 33, 34 and PILOT SELECTORS 1, 2, 27, 28, 29, 30. These selectors are transferred when the current earnings card is at third reading and the YTD card is at second reading.
4. The 4 code (YTD card) impulse from the CODING SELECTOR picks CALCULATOR SELECTOR 3, LATCH SELECTOR 1 and 0-9 PICKUP of PILOT SELECTOR 37. The COUPLING EXIT of PILOT SELECTOR 37 emits to pick up CO-SELECTORS 8, 10, 11, 35, 36, 37, 38, 55, 56 and PILOT SELECTORS 11, 63. The CAL-

CULATOR and LATCH SELECTORS transfer immediately on cycle 3, the other selectors are transferred on cycle 4 when the YTD card passes third reading.

5. The 5 code (deduction card) impulse from the CODING SELECTOR picks CALCULATOR SELECTOR 4 and the 0-9 PICKUP hub of PILOT SELECTOR 42. The COUPLING EXIT impulse of PILOT 42 emits to pick CO-SELECTOR 12, 42 and PILOT SELECTOR 10. These selectors are transferred when deduction cards pass third reading.
6. CO-SELECTORS 31, 32, 40 are transferred as long as deduction cards are passing the reading stations. The 10 IMPULSE through transferred LATCH SELECTOR 1 is wired to pick up the CO-SELECTORS.
7. CO-SELECTORS 9, 43, 44, 45, 46, 47, 48 are transferred on the minor program cycle.
8. LATCH SELECTOR 2 PU is impulsed if NEGATIVE BALANCE SELECTOR 1 was transferred during the previous calculate time.
9. LATCH SELECTOR 2 PU is impulsed by the ZERO TEST hub. Check-calculations of rate, gross pay, and withholding tax, signal an error with the zero test feature.
10. LATCH SELECTOR 1 is dropped out on the minor program cycle. LATCH SELECTORS 2, 3 are dropped out on the minor first card cycle.
11. The LC (last card) hub impulses LATCH SELECTOR 5 DROPOUT. Figure 81 shows the use of this latch selector.
12. Employee number is compared. A change in employee number causes a MINOR PROGRAM START and is also wired to PICKUP of CALCULATOR SELECTOR 5.

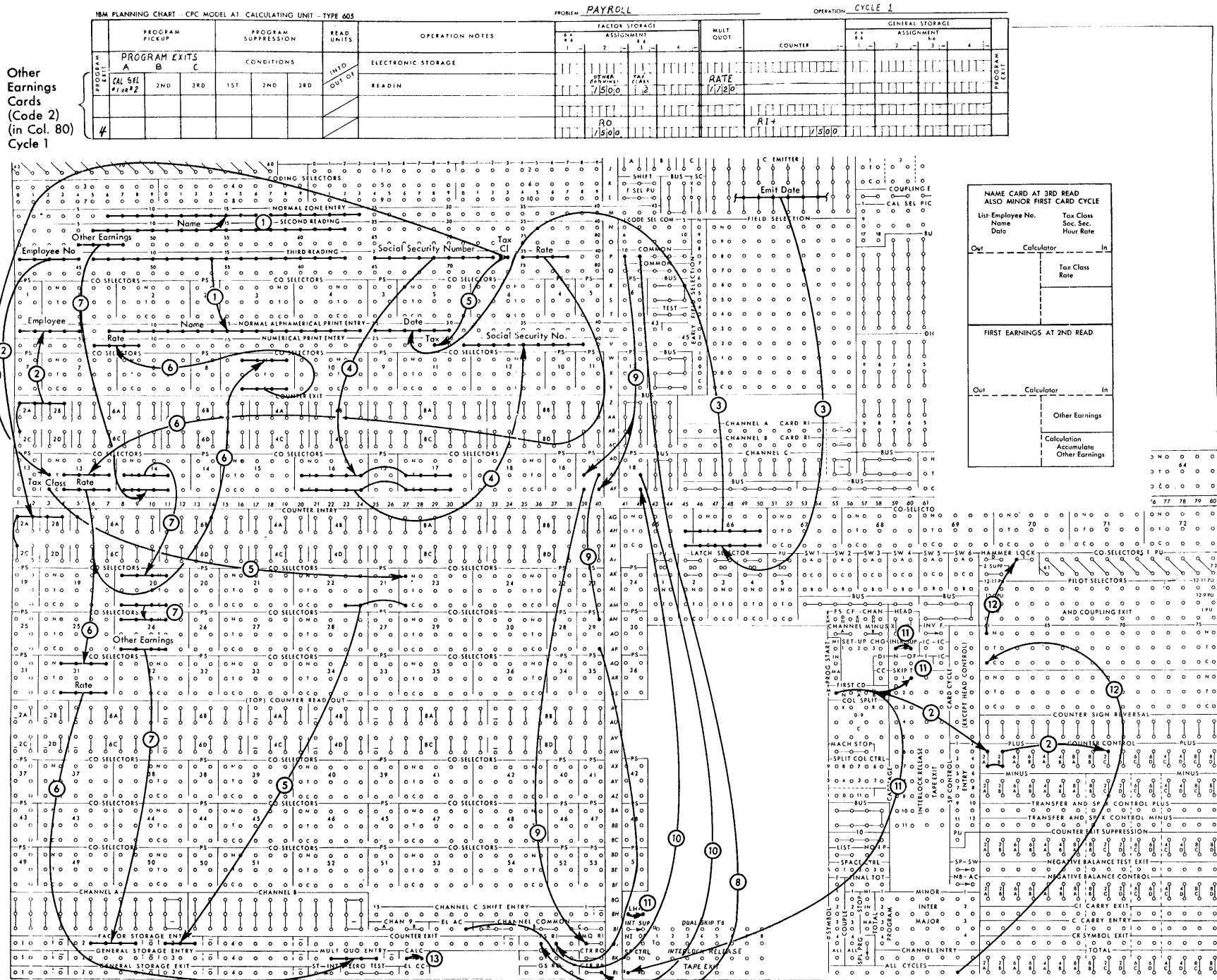

FIGURE 70. CYCLE 1 DIAGRAM

Cycle 1 (Figure 70)

This diagram shows the wiring for events that occur on cycle one.

WIRING: ACCOUNTING MACHINE CONTROL PANEL

1. Employee name is listed in alphamerical print entry 7-24 from columns 6-23.
2. Employee number, columns 1-5, is wired into COUNTER ENTRY 2A, 2B, 2C for summary punching. Employee number is printed by wiring from COUNTER 2A, 2B, 2C EXITS to ALPHAMERICAL PRINT ENTRY 1-5. The counters are controlled to add by wiring from MINOR FIRST CARD to COUNTER PLUS 2A, 2B, 2C.
3. The payroll date is printed by wiring from the C EMITTER through CO-SELECTORS 65 and 66 to ALPHAMERICAL PRINT ENTRY. Payroll date is changed from week to week by altering the C EMITTER wiring.
4. Social security number is printed by wiring from THIRD READING through the transferred side of CO-SELECTORS 16 and 17 to ALPHAMERICAL PRINT ENTRY.
5. Tax class is wired from column 34 to print in NUMERICAL PRINT ENTRY 29. Tax class is also wired through the transferred CO-SELECTOR 13 and the normal side of CO-SELECTOR 23 to FACTOR STORAGE 3 ENTRY.
6. Hourly rate is read at THIRD READING and wired through transferred CO-SELECTOR 13. It is then split wired to two places. Rate is printed by wiring through CO-SELECTOR 9 to NUMERICAL PRINT ENTRY. Rate is read into MULT-QUO ENTRY by wiring from CO-SELECTOR 13 through the normal side of CO-SELECTOR 31.
7. Since the first earnings card is at second reading on this cycle, the other earnings field is read in-

to the calculator. This is done by wiring from SECOND READING, columns 45-48, through the transferred side of CO-SELECTOR 14 and the normal of CO-SELECTORS 20 and 26 to FACTOR STORAGE 2 ENTRY.

8. FS RI for factor storage 2 is wired direct from 10 COMMON. Thus FS2 is reset on each cycle.
9. The 10 COMMON hub is also wired through the transferred PILOT SELECTOR 17 to cause FS 3 RI and the MQ RI to reset their respective storage units on this cycle.
10. ELECTRONIC ALL CYCLES is wired through the transferred side of PILOT SELECTOR 18 to the 605 COUNTER RR hub. This resets the counter at the beginning of each employee group.
11. MINOR FIRST CARD to SPACE CONTROL 2 provides an extra space between employees on the payroll register. MINOR FIRST CARD to SKIP TO 1 IMMEDIATE causes the left carriage to skip to the next payroll check. INTERLOCK SUPPRESS switch and LEFT-HAND carriage switch are jack-plugged.
12. Hammerlock levers are operated on all cycles except the first cycle to prevent printing in the employee number and name fields. This wiring is from ALL CYCLES through the normal side of PILOT SELECTOR 61 to HAMMERLOCK I PICKUP.
13. The CALCULATOR SWITCH is jackplugged.

Calculator Planning Chart (Figure 70)

PROGRAM EXITS A4-6 are active, however only program step 4 is used. Other earnings amount is read out of FS2 to the COUNTER +. Thus if several "other earnings" cards precede the current earnings card their amounts are accumulated in the electronic counter.

Cycle 2 (Figure 71)

This figure shows the wiring and planning chart for events that occur on cycle 2. Base wages, over-time premium, gross and withholding tax are calculated on this cycle. No printing occurs as this is a non-print cycle.

WIRING: ACCOUNTING MACHINE CONTROL PANEL

1. "Other earnings" is wired from THIRD READING, columns 45-48 through CO-SELECTOR 2 normal and CO-SELECTOR 3 transferred to COUNTER 4A ENTRY. This counter accumulates other earnings and incentive earnings for printing on the check.
2. Counter 4A is controlled to add by wiring from CARD CYCLES through CO-SELECTOR 3 transferred to the PLUS and EXIT SUPPRESSION hubs.
3. Incentive earnings from SECOND READING, through CO-SELECTOR 14 normal and CO-SELECTOR 20 transferred is wired to FACTOR STORAGE 2 ENTRY (see figure 70 also).
4. Regular hours and overtime hours are wired from SECOND READING through CO-SELECTOR 15 normal and CO-SELECTOR 21 transferred.
5. Regular hours from CO-SELECTOR 21 passes through the normal of CO-SELECTORS 34 and 40 to FACTOR STORAGE 4 ENTRY.
6. Overtime hours from CO-SELECTOR 21 is wired to FACTOR STORAGE 1 ENTRY via CO-SELECTOR 22 normal.
7. The transferred side of CO-SELECTOR 15 is wired to normal of CO-SELECTOR 21 to cause regular and overtime hours to read into factor storage in the event that no "other earnings cards" are in an employee's deck. This path is used if the current earnings card follows the name card.
8. FS RI 1, 4 are wired to 10 COMMON. These storage units reset on read-in on every active machine cycle.

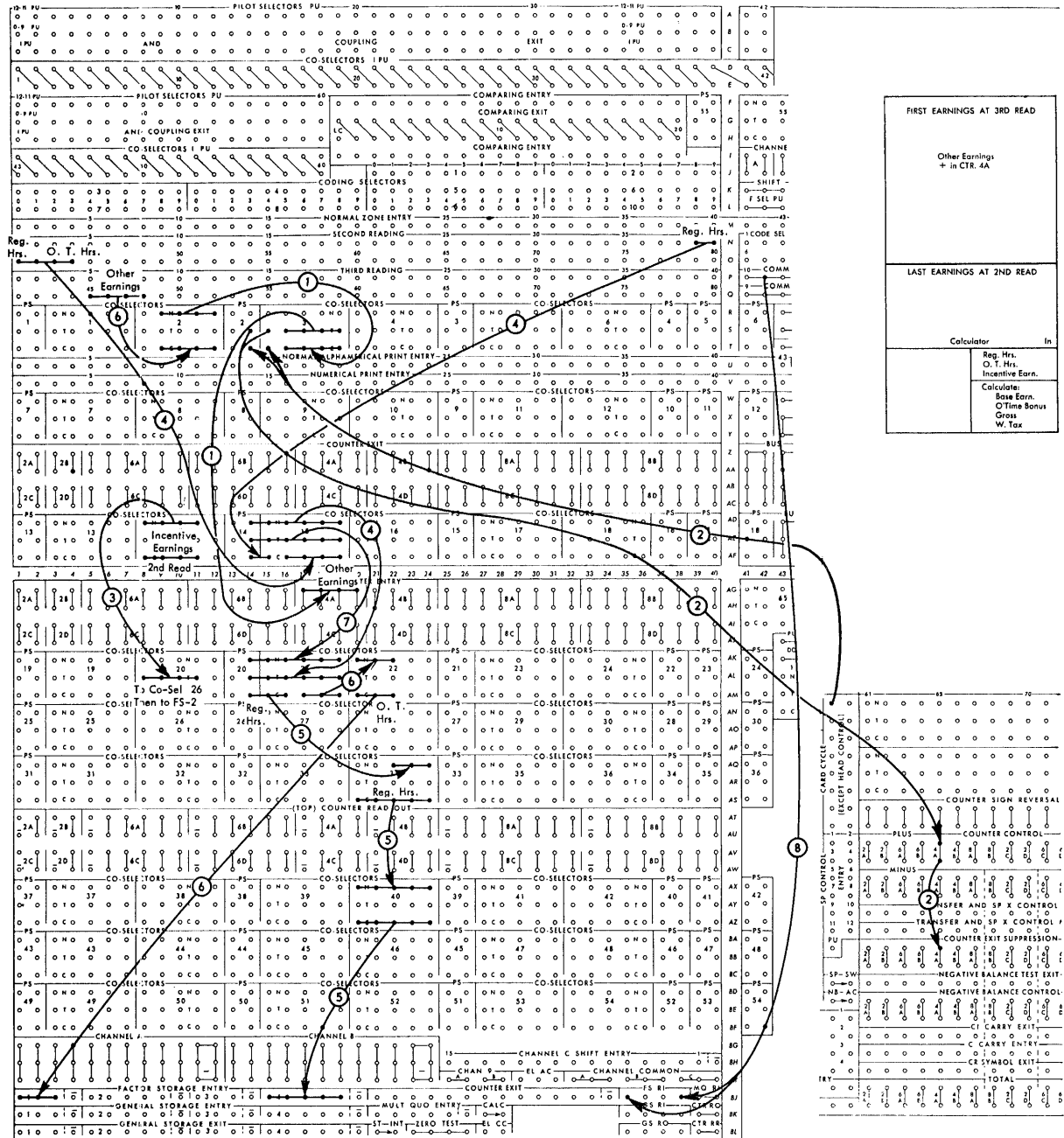

FIGURE 71. CYCLE 2, 412 DIAGRAM

Planning Chart (Figure 72)

1. PROGRAM EXITS A7-41 are active.
2. On step 7 the accumulated other earnings and incentive earnings are stored in FS 2. It is also stored in GS 2 for checking purposes.
3. Steps 8-11, 25, and 41 are explained under checking.
4. Steps 12-15 compute base earnings and store it in GS 4 for printing.
5. Base and other earnings are added and stored in FS 2 on steps 15 and 16.
6. Overtime is calculated and stored in GS 1, 3 on steps 17-24.
7. Steps 29-31 accumulate gross earnings and store in GS 2 for readout to the accounting machine.
8. Withholding tax is calculated on steps 26-28 and steps 32-40. It is stored in the counter for readout to the accounting machine. Taxable earnings is balance tested on step 32 to check for exemption amounts that are larger than gross pay. If the exemption is larger, PROGRAM STOP 37 is suppressed and withholding tax is zero.

IBM PLANNING CHART - CPC MODEL A1: CALCULATING UNIT - TYPE 605										FROM: PAYROLL				OPERATION: CURRENT EARNINGS CARD				CYCLE 2	
STEP	PROGRAM PICKUP			PROGRAM SUPPRESSION			READ UNITS	OPERATION NOTES	FACTORY STORAGE				MULT. QUOT.	GENERAL STORAGE					
	A	B	C	1ST	2ND	3RD			1	2	3	4		1	2	3	4		
PROGRAM EXITS	CONDITIONS			ELECTRONIC STORAGE			ASSIGNMENT				COUNTER								
CAL. No.	2NE	3RD	1ST	2ND	3RD	IN/D OUT/OT	READIN	1	2	3	4	1	2	3	4				
7							STORE OTHER EARNINGS	RI					RR						
8							RO MS TO COUNTER						RO	RI+					
9							RO FS TO COUNTER						RO	RI+					
10							RO GS TO COUNTER						RO	RI+					
11							ZERO TEST - RESET						RI-						
12							MPLY						RO						
13							1/2 ADJ						RO						
14							STORE BASE						RO						
15							BASE AND PREM.						RO	RI+					
16							STORE 1/2 GROSS IN FS 2						RI						
17							RO REGMS						RO	RI+					
18							HOURS X 2						RO	RI+					
19							PLACE DIVIDEND						RI						
20							DIVIDE - RESET						RO	RI+					
21							MPLY						RO						
22							1/2 ADJUST						RO						
23							STORE OVERTIME						RI						
24							STORE OTHER & INCENTIVE EARNINGS FOR CHECKING						RI						
25							EMIT 1						RI+						
26							EMIT 2						RI+						
27							EMIT 3						RI						
28							GROSS EARNINGS						RI+						
29							STORE GROSS						RO						
30							MPLY MINUS BALANCE TEST						RO						
31							EMIT 1						RI						
32							EMIT B						RI+						
33							MPLY MINUS						RO						
34							1/2 ADJ WITH HOLDING TAX						RO						
35							MULTIPLY +						RO						
36							STORE GROSS						RO						
37							EMIT 1						RI						
38							EMIT B						RI+						
39							MULTIPLY +						RO						
40							STORE GROSS						RO						
41							RO TO ACCOUNTING MACHINE						RO						

FIGURE 72. CYCLE 2, 605 PLANNING CHART

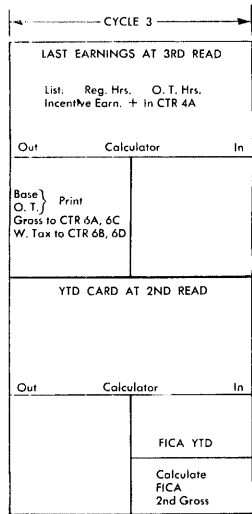

IBM PLANNING CHART - CPC MODEL A1, CALCULATING UNIT - TYPE 605										PROGRAM PAYROLL				OPERATION YEAR TO DATE CARD CYCLE 3					
PROGRAM UNIT	PROGRAM EXITS			PROGRAM SUPPRESSION			READ UNITS	OPERATION NOTES	FACTOR STORAGE ASSIGNMENT				MULTI QUOT	GENERAL STORAGE ASSIGNMENT					
	CONDITIONS			INTO	OUT OF	ELECTRONIC STORAGE			1	2	3	4		COUNTER					
	1ST	2ND	3RD											1	2	3	4		
1							6	SAVE OTHER + INCENTIVE EARNINGS											
2							2	SAVE WITH TAX											
3																			
4							3	MPLY + RECOMPUTE GASE											
5							4	1/2 ADJ											
6							4	BASE + OTHER EARNINGS											
7							4	STORE BASE + OTHER EARNINGS											
8																			
9																			
10							3	2X HOURS											
11							3	PLACE DIVIDEND											
12																			
13							2	1/2 ADJ											
14							3	BASE + PREM + O.T.											
15							3	SUBTRACT ORIGINAL GROSS											
16							3	ZERO TEST RESET											
17																			
18							4	EMIT 1											
19							5	EMIT 2											
20																			
21																			
22																			
23																			
24																			
25							2	MULT + EMIT 2											
26							3	1/2 ADJ											
27							3	SAVE 2% GROSS											
28																			
29																			
30																			

FIGURE 73A. CYCLE 3, 605 PLANNING CHART, PART 1

Cycle 3 (Figures 73A and B)

On this cycle the last earnings card passes third reading and the YTD card passes second reading. During calculate time PROGRAM EXITS B1-60 are active, however, only steps 20-30 and 54-57 are used to compute original amounts. The majority of the program steps are used in checking of previous calculations.

The following program exits are used in checking functions and are explained in that section. PROGRAM EXITS 1-19, 31-53, 58-60.

FICA is calculated and stored in Gs 1, 3 on steps 20-30. FICA-YTD is checked against the \$72.00 limit.

Gross - FICA - With Tax is computed and stored in Gs 2 on steps 54-57. This second gross will be further reduced by other deduction amounts on succeeding cards to obtain net pay.

CHECK WITH TAX	31	5	EMIT 1						RI+							
	32	4	EMIT 3						RI+	3						
	33	2							RI	1/3/00						
	34								RI+	1/2/93						
	35			MPLY MINUS	BALANCE TEST	RO				MULT-	2.000					
	36								RI	1/3/00						
RECAL. FICA	37	2	EMIT 1						RI	1/1						
	38	2	EMIT 8						RO	1/1						
	39			MPLY					RI	1/1						
	40	3	1/2 ADJ						RO	1/1						
	41	4														
	42	4	ZERO TEST - RESET													
	43	5	EMIT 7						RI+	7						
	44	4	EMIT 2						RI+	2						
	45	2							RI	1/00						
	46	2							RI DIFF	1/00						
	47								RI GROSS	1/00						
	48								RI	1/00						
	49	2	MULT +	EMIT 2					RI	1/00						
	50								RI	1/00						
	51	3	1/2 ADJ						RI	1/16						
52								RI	1/16							
2ND GROSS	53								RI	1/16						
	54								RI+	GROSS						
	55								RI	1.00						
	56								RI	1.752						
	57								RI	1.752						
	58								RI	1.752						
	59								RI	1.752						
	60	6							RI	1.752						
	61								RI	1.752						
	62								RI	1.752						
SET UP FOR READ OUT TO P12 MACHINE	63								RI	1.752						
	64								RI	1.752						

FIGURE 73B. CYCLE 3, 605 PLANNING CHART, PART 2

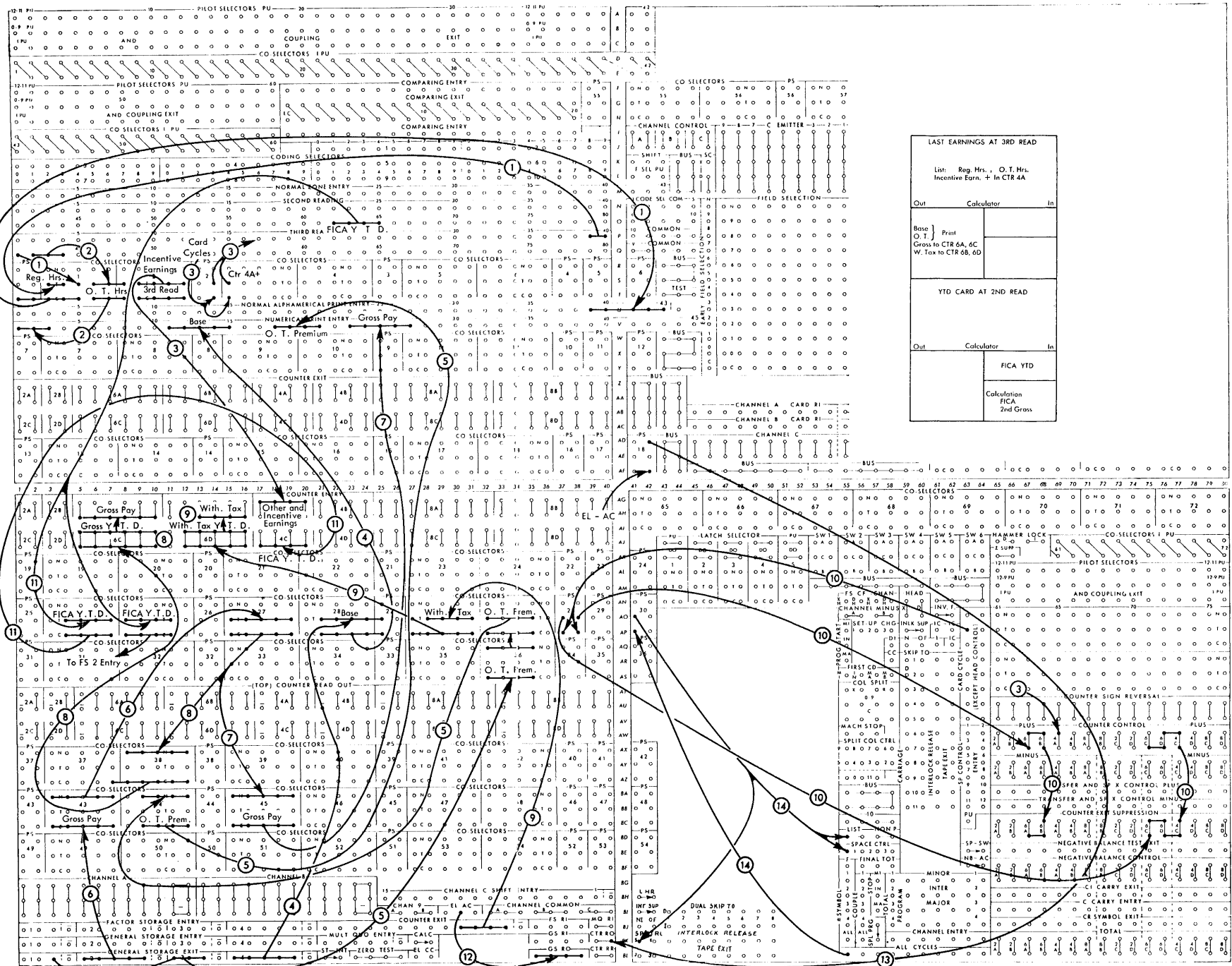

LAST EARNINGS AT 3RD READ		
List: Reg. Hrs., O. T. Hrs. Incentive Earn. + In CTR 4A		
Out	Calculator	In
Base	Print	
O. T.	Gross to CTR 6A, 6C	
W. Tax	to CTR 6B, 6D	
YTD CARD AT 2ND READ		
Out	Calculator	In
	FICA YTD	
	Calculation	
	FICA	
	2nd Gross	

FIGURE 74. CYCLE 3, 412 DIAGRAM

Cycle 3 (Figure 74)

On this cycle the last earnings card and YTD card pass the third and second read stations respectively. Amounts printed are regular hours, overtime hours, base earnings, overtime premium and gross pay. Spacing is suppressed so printing occurs on the same line as name and employee number were printed.

WIRING

1. Regular hours is printed by wiring from THIRD READING through CO-SELECTOR 1 transferred to ALPHAMERICAL PRINT ENTRY.
2. THIRD READING columns 42-44 through CO-SELECTOR 1, 2 transferred to NUMERICAL PRINT ENTRY causes overtime hours to print.
3. Incentive earnings of the last earnings card is added in counter 4A by wiring from the transferred of CO-SELECTOR 2 to 4A ENTRY. The PLUS hubs of COUNTER 4A are impulsed to cause the counter to add by the split wiring of PILOT SELECTOR 2 and CO-SELECTOR 3 hubs. See Figure 71 for further details.
4. Base earnings is read out of gs 4 through transferred CO-SELECTOR 28 to NUMERICAL PRINT ENTRY 11-15.
5. Overtime premium is read out of gs 1, 3 through normal CO-SELECTOR 36, transferred CO-SELECTOR 30, and normal CO-SELECTOR 44 to NUMERICAL PRINT ENTRY 18-21.
6. Gross pay is read out of gs2 through normal of CO-SELECTOR 43 and to transferred CO-SELECTOR 27. It is then split wired in two separate paths as explained under wiring 7 and 8.
7. Gross pay is printed by wiring from CO-SELECTOR 27 through normal CO-SELECTOR 45 to NUMERICAL PRINT ENTRY.
8. Gross pay is wired through normal CO-SELECTOR 38 to COUNTER 6A and 6C ENTRY. COUNTER 6C accumulates gross year to date and COUNTER 6A stores gross pay for summary punching.
9. Withholding tax is read out of the electronic COUNTER through the transferred CO-SELECTOR 29 to COUNTER 6B and 6D ENTRY.
10. COUNTERS 6A, 6B, 6D, 4C are controlled to add by wiring a CARD CYCLES impulse through the transferred CO-SELECTOR 28 to the COUNTER PLUS and EXIT SUPPRESSION hubs. Two separate paths are set up because counters 6C, 6D and 4C will be controlled to add on the next cycle also when counter 6A and 6B should not add.
11. FICA YTD from SECOND READING is split wired to two places: through transferred CO-SELECTOR 25 to COUNTER 4C ENTRY; through transferred CO-SELECTOR 26 to FACTOR STORAGE 2 ENTRY. (See figure 70 for further details.) Counter 4C is used to accumulate a new FICA YTD.
12. ELECTRONIC ALL CYCLES to GS RO 1, 2, 3, 4 causes the GS units to read out on all cycles.
13. PILOT SELECTOR 18 is normal on all cycles except the minor first card cycle. Therefore wire 13 causes the electronic counter to read-out without reset on all active cycles except minor first card. See Figure 70 for further details.
14. An ALL CYCLES impulse through transferred PILOT SELECTOR 30 to the LIST and to SPACE SUPPRESS hub causes a print cycle without spacing either form.

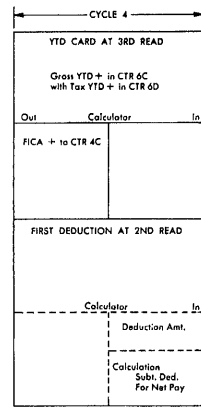
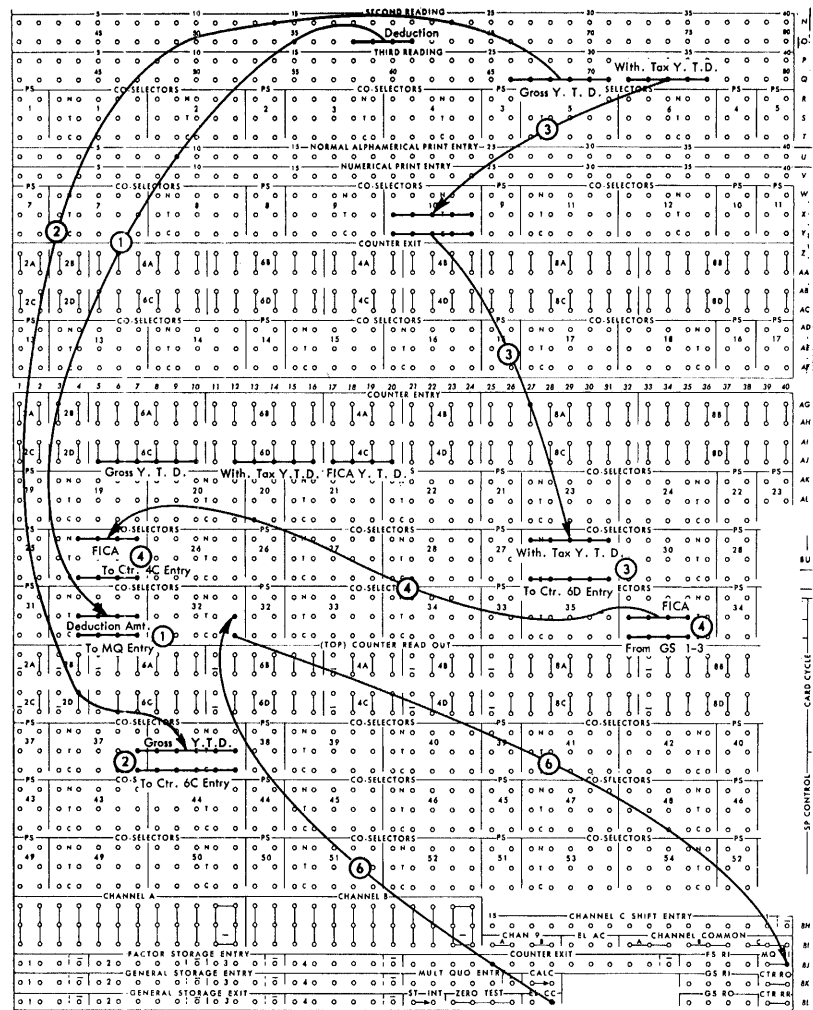

Cycle 4 (Figure 75)

On this cycle the YTD card is at third read and the first deduction card is at second read. Year-to-date amounts are added into 412 counters. Deduction amount is subtracted from second gross.

WIRING

1. Deduction amount is entered into MQ through transferred CO-SELECTOR 31. See Figure 70 also.
2. Gross YTD is read from THIRD READING through transferred CO-SELECTOR 38 into COUNTER 6C ENTRY. See Figure 74 also.
3. Withholding tax YTD is wired from THIRD READING through transferred CO-SELECTOR 10 and normal CO-SELECTOR 29 to COUNTER 6D ENTRY. See Figure 74 also.
4. GS 1, 3 read out FICA through CO-SELECTOR 36 transferred and CO-SELECTOR 25 normal to add in COUNTER 4C. COUNTER 4C now contains the new FICA YTD. See Figure 74 also.
5. CARD CYCLE is wired through transferred PILOT SELECTOR 63 to COUNTER PLUS. This causes counters 6C, 6D, and 4C to add.
6. MQ RI is wired through the transferred CO-SELECTOR 32 from the ELCC hub.

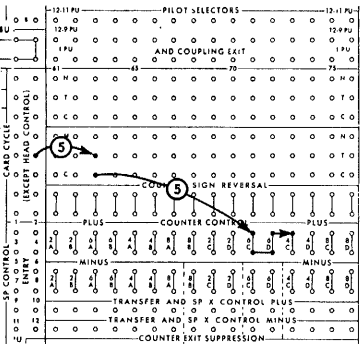

FIGURE 75. CYCLE 4, 412 DIAGRAM

Cycles 4 and 5—Type 605 Planning Chart
(Figure 76)

PROGRAM EXITS A57-60 are active.

Second gross is in gs2 from the previous calculation. Deduction amount is subtracted from second gross and the counter is balance tested for step suppression and for selector pickup. If the deduction amount is not larger than the second gross, the new gross is stored in gs2. Thus gs2 contains the amount which

will become net pay after the last deduction card is subtracted. If an employee has no deduction cards this series of program steps are not active and the second gross amount becomes net pay.

Note that step 60 is suppressed if the counter balance was negative on step 59. A negative balance in the counter prevents this deduction amount from subtracting from second gross. It also prevents this deduction amount from adding into the total deduction counter on the 412 control panel.

85

IBM PLANNING CHART—CPC MODEL A1: CALCULATING UNIT—TYPE 605										PROBLEM _____				OPERATION <u>DEDUCTION CARDS - CYCLE 4&5</u>						
PROGRAM EXIT	PROGRAM PICKUP			PROGRAM SUPPRESSION			READ UNITS	OPERATION NOTES	FACTOR STORAGE				MULT QUOT.	COUNTER	GENERAL STORAGE				PROGRAM EXIT	
	A	B	C	A CONDITIONS					INTO OUT OF	4.4 8.4	ASSIGNMENT	1			2	3	4	4.4 8.4		ASSIGNMENT
	COL SEL No. #	2ND	3RD	1ST	2ND	3RD														
								ELECTRONIC STORAGE												
								READ IN												
57								CLEAR COUNTER												
58																				
59								TEST FOR EXCESSIVE } BAL. TEST FOR SEL PU No. 1 DEDUCTIONS } BAL. TEST FOR SUPPRESSION												
60					SUPP ON MINUS															
								NET PAY IS READ OUT FROM GS2 AFTER LAST DEDUCTION CARD HAS BEEN READ												

FIGURE 76. CYCLE 4 AND 5, 605 PLANNING CHART

Cycles 5 and 6 (Figure 77)

CPC operation on these two cycles is quite simple. The first deduction card passes THIRD READING and the last deduction card passes SECOND READING on cycle 5. The last deduction card passes third reading on cycle 6.

Since this is the last card of an employee group a MINOR PROGRAM START is initiated (wiring on Figure 69).

WIRING: FIGURE 77

1. This dotted wiring was shown on the previous figure also. It is repeated here to show that deduction amount from the "last deduction card" is read into MQ.
2. Deduction amount from THIRD READING is wired through transferred CO-SELECTOR 42 to COUNTER 4B ENTRY.
3. A CARD CYCLES impulse is wired through normal NEGATIVE BALANCE SELECTOR and transferred CO-SELECTOR 42 to COUNTER 4B PLUS and EXIT SUPPRESSION. Thus the deduction amount from THIRD READING adds into counter 4B only if the calculator subtracted that amount from gross pay during the previous calculate time. If the deduction amount were greater than second gross the negative balance selector is transferred and prevents adding into counter 4B.

On cycle 5, the 605 calculator repeats the program that was active on cycle 4. That is, PROGRAM EXITS A57-60 are active. No calculation occurs on cycle 6. For example: A deduction card for \$4.00 would reduce the amount in gs2 of Figure 76 to \$97.81. This amount would then become net pay.

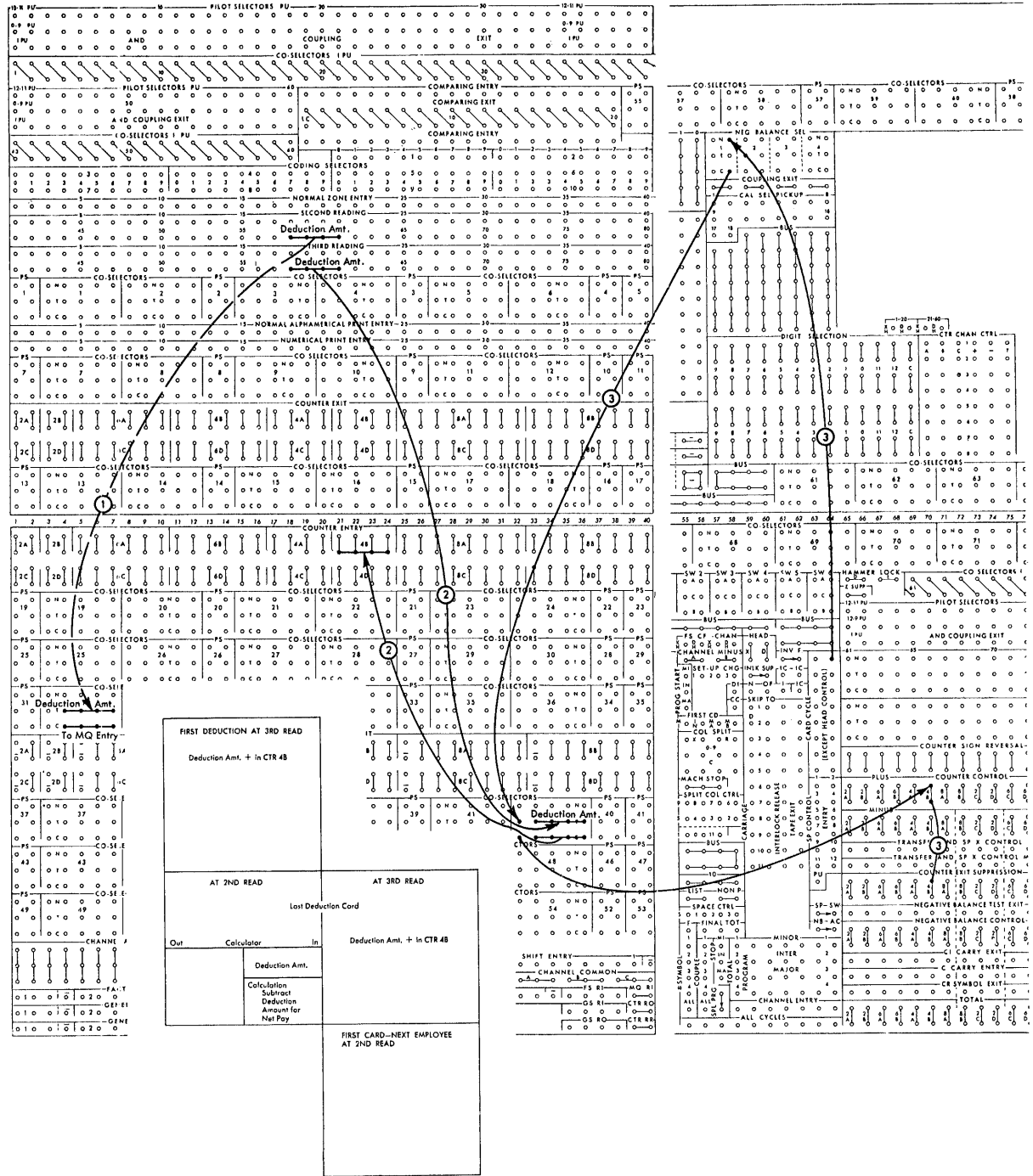

FIGURE 77. CYCLE 5 AND 6, 412 DIAGRAM

Cycle 7

This is a minor program cycle. It is preceded by a summary punch operation where a new year to date card is punched. No calculation occurs in the 605 on the minor program cycle although net pay and FICA are read-out to print from GS units.

Summary Punch Control Panel (Figure 78)

1. CALC SWITCH is jackplugged ON.
2. DIGIT IMPULSE is jackplugged to the c of DIGIT SELECTOR. An EMITTED 4 is punched in all summary cards to identify them as a YTD card.
3. Week number is emitted and punched in column 28, 29. The emitted number is changed each week.
4. CARD CYCLES is wired to GENERAL STORAGE 2 and 3 READ OUT.
5. GENERAL STORAGE 2 reads out net pay to punch in columns 6-10.
6. FICA is read out of gs3 and punched in columns 19-21.
7. Employee number is punched from COUNTER 2A, 2B, 2C EXITS.
8. Deduction amount is readout and punched from COUNTER 4B EXITS.
9. COUNTER 6B reads out withholding tax to punch.
10. Gross pay is punched from COUNTER 6A EXITS.
11. COUNTER 6C punches gross YTD in columns 66-71.
12. Withholding tax YTD is punched from COUNTER 6D EXITS.
13. FICA YTD is punched from COUNTER 4C EXITS.

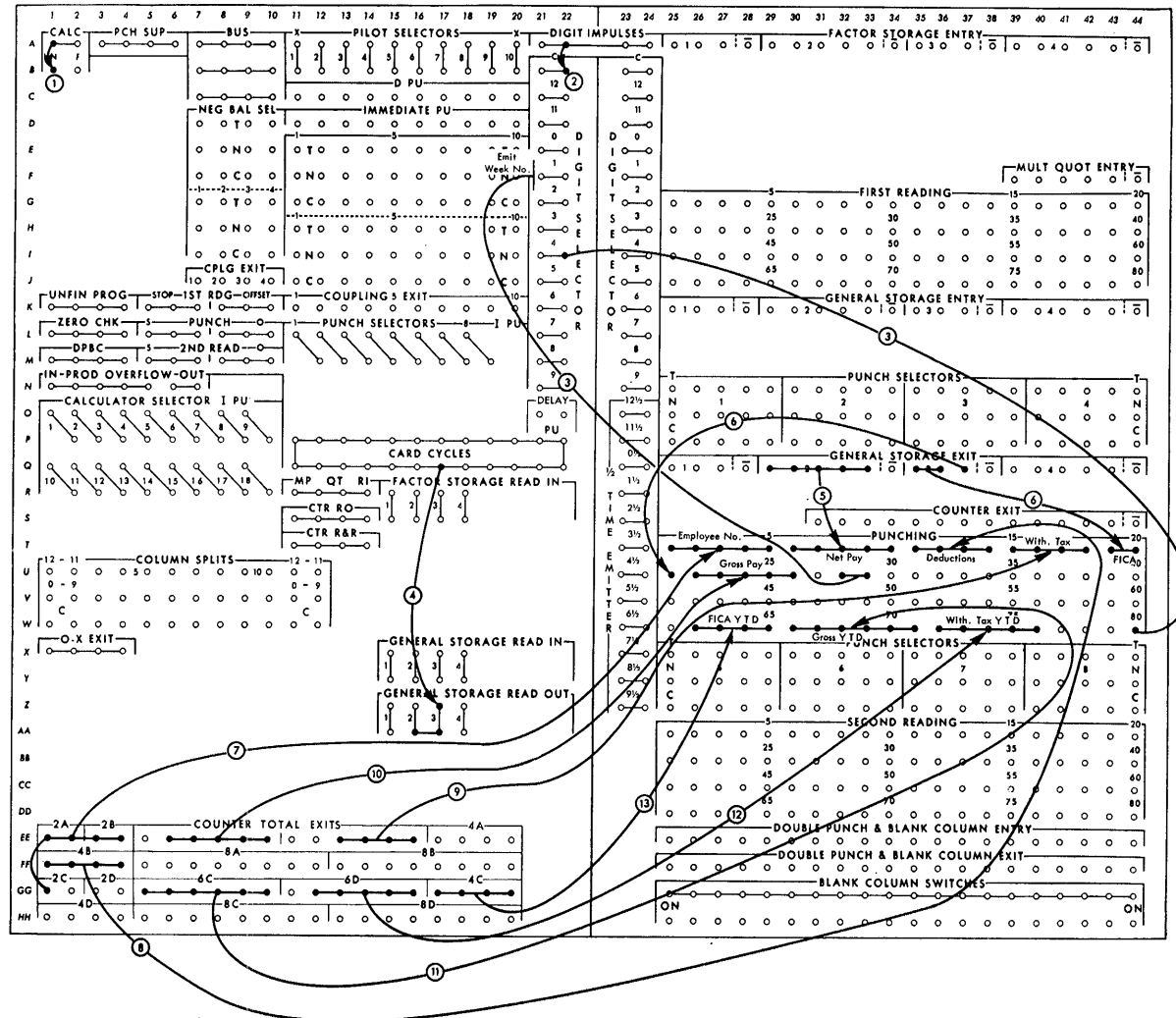

FIGURE 78. CYCLE 7 SUMMARY PUNCHING

Cycle 7, Minor Program Cycle (Figure 79)

WIRING

1. Net pay is printed in two places. It is read out of gs2 through transferred CO-SELECTOR 43 directly to ALPHAMERICAL PRINT ENTRY 31-35, and also through normal of PILOT and CO-SELECTOR 1 to ALPHAMERICAL PRINT ENTRY 39-43. See Figure 74 also.
2. "Other earnings" is printed by wiring from COUNTER 4A EXITS through CO-SELECTOR 9 transferred to NUMERICAL PRINT ENTRY 6-9. See Figure 70 also.
3. GS 1-3 read out FICA. FICA wiring on this figure begins at CO-SELECTOR 30. It is wired through transferred CO-SELECTOR 48 and normal of CO-SELECTOR 28 to NUMERICAL PRINT ENTRY 11-15. See Figure 74 also.
4. Withholding tax is read out of COUNTER 6B exits through CO-SELECTOR 44 to NUMERICAL PRINT ENTRY 18-21. See Figure 74 also.
5. Deduction amount is read out of COUNTER 4B EXITS through transferred CO-SELECTOR 45 to NUMERICAL PRINT ENTRY 24-27. See Figure 74 also.
6. If any deduction card amounts are greater than the second gross pay amount those deductions are not subtracted from gross pay *nor* added into the deduction counter 4B. This situation is recognized by transferring NEGATIVE BALANCE SELECTOR 1 which (on Figure 69) picked up LATCH SELECTOR 2. Wiring 6 shows a MINOR PROGRAM SYMBOL impulse wired through the transferred LATCH SELECTOR to print an asterisk in NUMERICAL PRINT ENTRY 28. This signals that a deduction card amount was not included in the total deduction amount shown on the check.
7. Gross YTD earnings is printed by wiring from COUNTER 6C EXITS through normal CO-SELECTOR 16 and 17 to NUMERICAL PRINT ENTRY 34-39. See Figure 70 also.
8. Withholding tax YTD is printed by wiring from COUNTER 6D EXITS to NUMERICAL PRINT ENTRY.
9. COUNTER 2A, 2B, 6A, 6B, 4A, 2C, 6C, 6D, 4C and 4D TOTAL is impulsed on the minor program cycle.
10. MINOR program to SPACE 1 causes a single space on the register form. It is split wired to SKIP TO 3 IMMEDIATE to skip the pay check to the second line of printing.
11. Summary punch wiring includes jackplugging the SPSW switch and impulsing SP CONTROL PU from MINOR PROGRAM.

SECTION TWO: CHECKING FEATURES

A NUMBER of different checking techniques are used in this application. Results are recalculated and zero balanced against the original calculation in the 605; the 412 comparing unit is used to compare the same field read from two separate sources; a 412 counter adds and subtracts amounts which are then checked for zero balance in the comparing unit. Checking for the first card group is set up by placing a card (punched only with a code 4 in column 80) in front of the card deck.

A checking error is recognized in one of two ways. A discrepancy in the checking of FICA YTD, other + incentive earnings, or net pay stops the machine. A discrepancy discovered in the 605 checking programs emits a zero test impulse which causes an asterisk to be printed in numerical print entry. The two methods are used to illustrate flexibility. Another method of signalling an error that is commonly used in CPC commercial applications is to print a digit code on the report. Each digit printed identifies the type of error that occurred.

The Basic Checking Formulas

1. Gross (original)—other and incentive earnings (checked at 3rd read)
—overtime premium (recalculated)
—base wages (recalculated) = "0"
2. Gross (original)—net pay (original) - deductions (read at 3rd read)
—withholding tax (recalculated)
—FICA (recalculated) = 0

Planning Chart (Figure 80)

The planning for this checking begins when the name card is at second reading. Rate and tax class are stored in the calculator.

On cycle 1 the name card is at third reading where rate and tax class are again read into the calculator (for original base wage calculation) and also into counter 4B and 2D for future use.

During calculate time of cycle 2 the rate and tax class from second read are zero balanced against the rate and tax class from third read. The original gross and withholding tax are then calculated.

On cycle 3 the current earnings card is at third reading. Base wages, overtime premium, gross pay, withholding tax and FICA are recalculated. The recalculated gross is zero balanced against the original gross. This completes the first checking formula.

The original gross pay was read out and added in counter 8A. Thus counter 8A is beginning to develop the second checking formula. Other and incentive earnings used in the gross pay calculation are readout from the 605 to a 412 counter.

On successive card cycles counter 8A subtracts the recalculated withholding tax, recalculated FICA, and deduction amounts from third reading. On the minor program cycle counter 8A subtracts net pay. The counter should now contain a zero balance (all nines). On the minor first card cycle counter 8A is readout to the comparing unit and checked for a zero balance.

The following diagrams show the control panel wiring that was added to the section one diagrams to accomplish checking. The calculator planning charts of section one have shaded and unshaded areas. Refer to the shaded areas for the 605 planning that is described in the checking text.

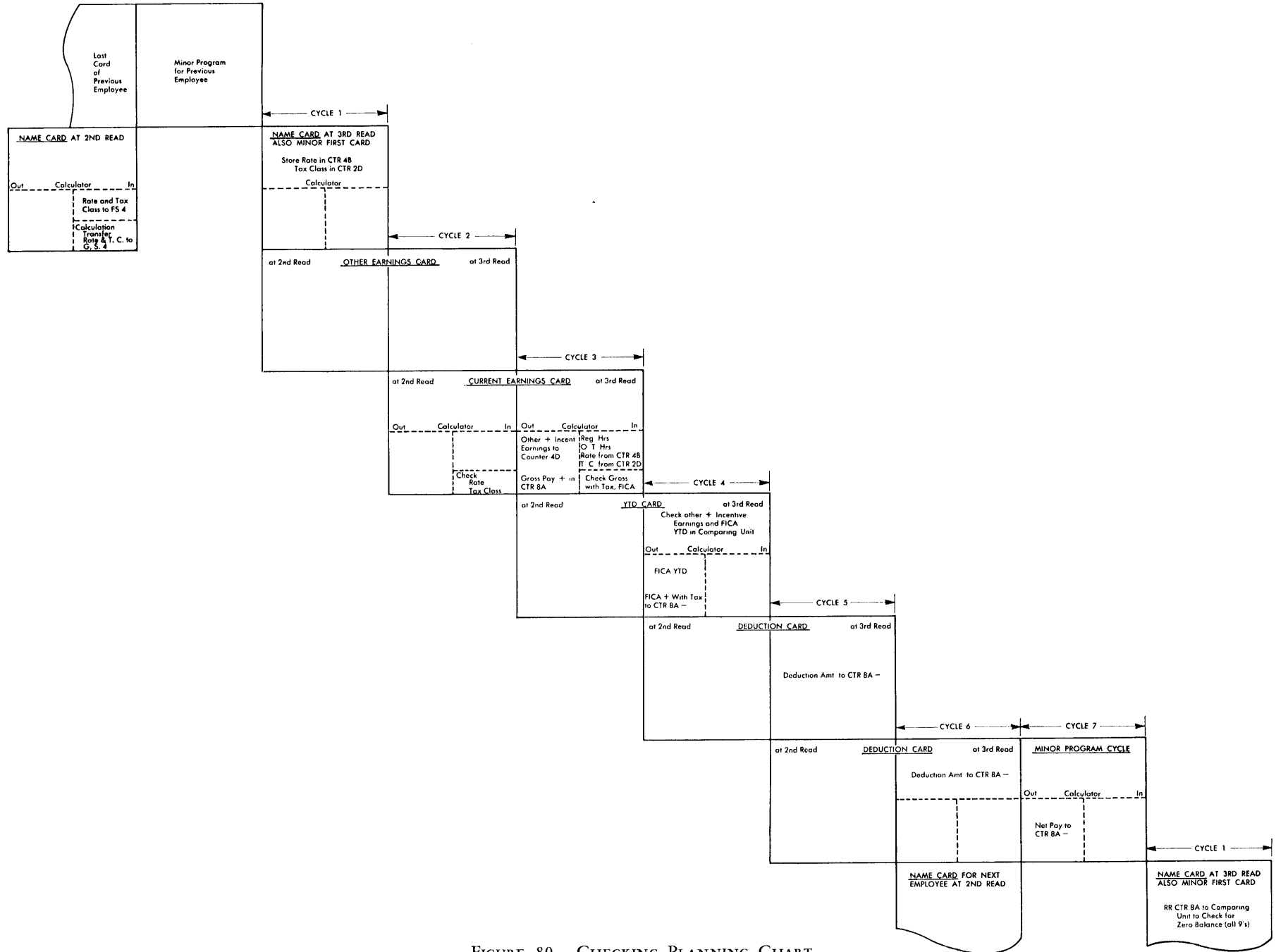

FIGURE 80. CHECKING PLANNING CHART

Last Card of Previous Employee (Figure 81)

On this cycle the name card passes second read where rate and tax class are read and stored in the calculator for checking purposes.

Figure 81 also shows a selector checking method. PILOT and CO-SELECTOR pickups are impulsed from a digit code (col. 80) at SECOND READING. This checking feature insures that the proper selectors were picked. The column 80 code from THIRD READING is compared against a digit emitted through the transferred SELECTOR.

WIRING

1. Tax class, column 34 is read into the high order position of FS4. Rate is read into the low order four positions of FS4. These fields are read from the employee name card. See Figure 71 also.
2. Digits 1, 2, 3, 4, 5 from C EMITTER are wired to the transferred side of a SELECTOR, whose PU hub was impulsed as a result of a corresponding digit code on the previous cycle.
3. COMPARING ENTRY is wired from the common and normal wiring of SELECTORS 17, 22, 30, 36, 31.
4. COMPARING ENTRY wired from card code, column 80, THIRD READING.
5. COMPARING EXIT TO IMMEDIATE PU OF PILOT 65, stops the CPC if a card code discrepancy is recognized. See Figure 84 for further details.
6. This wiring causes the total cycle for the blank card in the front, and in the rear of the card deck to be non-print cycles.

Planning Chart

PROGRAM EXITS A 1-3 are active. Only program step one is used. Tax class and rate are transferred to gs4 because fs4 reads in from following earnings cards before tax class and rate are used in the calculator.

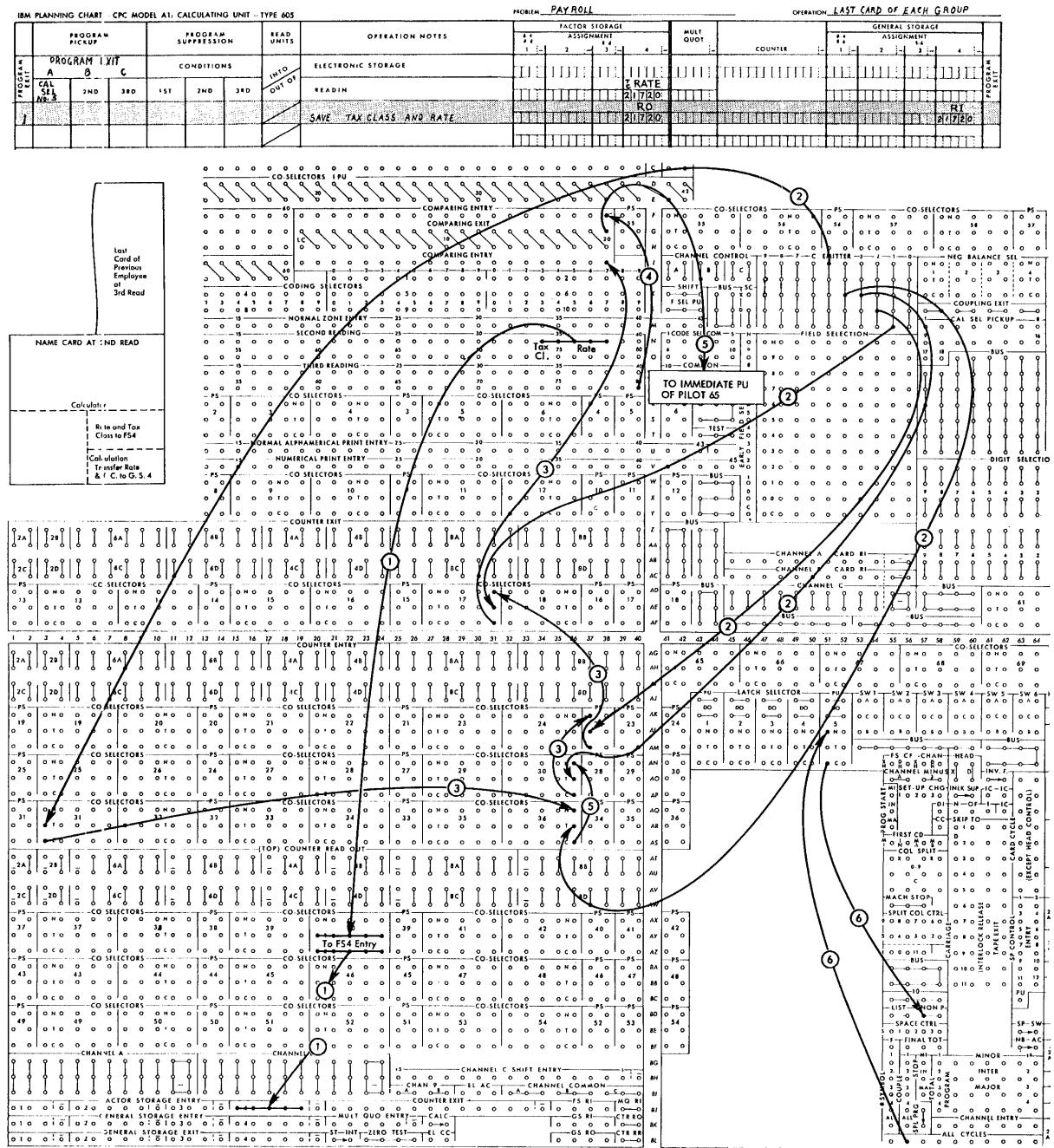

FIGURE 81. CHECKING: LAST CARD CYCLE OF PREVIOUS EMPLOYEE

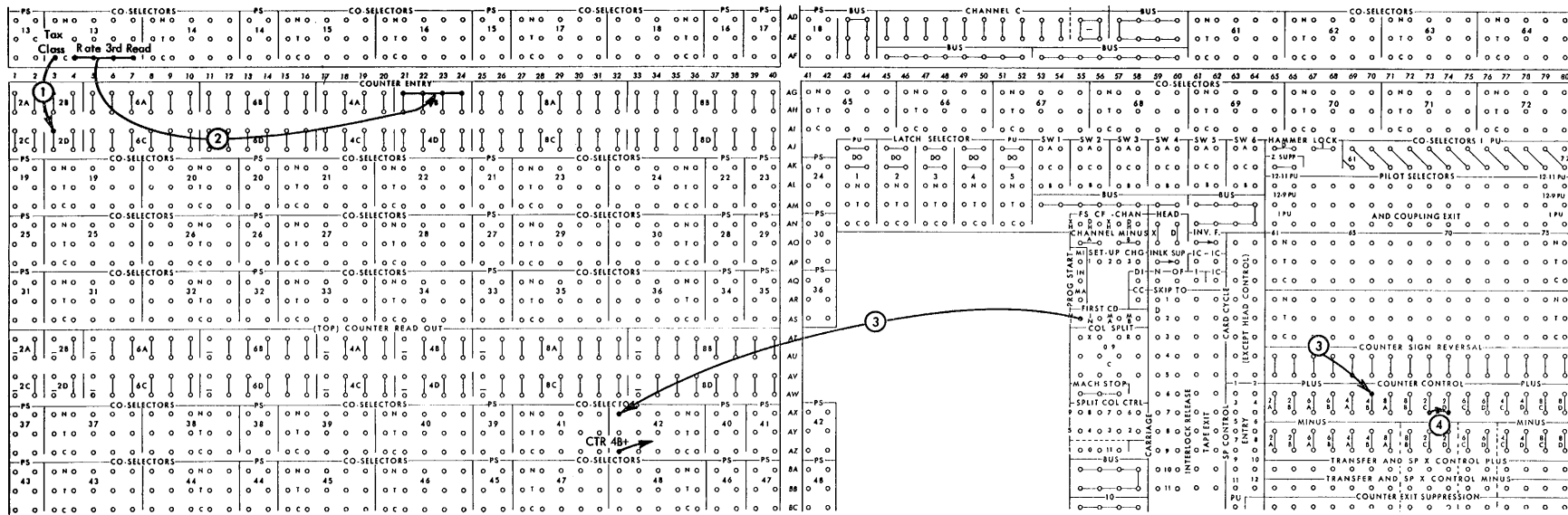

FIGURE 82. CHECKING: CYCLE 1, CYCLE 2

Checking Cycle 1 (Figure 82)

WIRING

1. Tax class from THIRD READING is stored in COUNTER 2D.
2. Rate from THIRD READING is stored in COUNTER 4B for future use.
3. MINOR FIRST CARD to normal of CO-SELECTOR 42 causes COUNTER 4B to add. See Figure 77 also.
4. COUNTER 2D PLUS is jackplugged to COUNTER 2C PLUS. COUNTER 2C PLUS wiring was shown on a previous diagram (Figure 70).

Certain checking functions for the previous employee also occur on this cycle which are not explained at this time. They will be explained in their proper sequence on the last diagram.

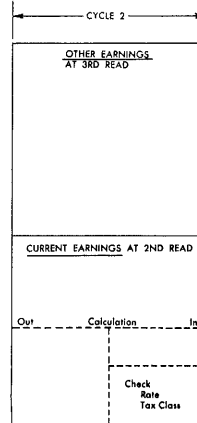
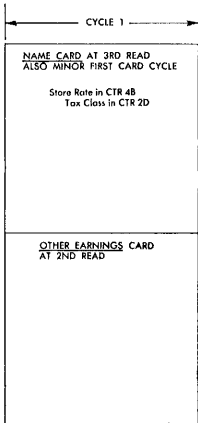

Cycle Two Planning Chart (See Shaded Areas of Figure 72)

During calculate time of cycle 2 the original calculations of base wages, overtime, gross and withholding tax are made.

However, before these calculations begin, the rate and tax class (in GS4) from SECOND READING are zero balanced against the rate and tax class read from THIRD READING (FS3 and MQ).

PROGRAM EXITS A8-11, 25, 41 are checking program steps. STEPS A8-11 ZERO BALANCE rate and tax class. Steps 25 and 41 position the other and incentive earnings amount for readout from the electronic counter to the 412 machine.



FIGURE 83. CHECKING: CYCLE 3

Checking, Cycle 3 (Figure 83 and Shaded Areas of Figures 73A and 73B)

Extensive checking is programmed in the 605 on this cycle. All 60 of the B program exits are active and 43 of the steps are checking program steps. Current earnings card fields from third reading supply the source data for these calculations. Base wages, overtime, gross pay, withholding tax and FICA are all recalculated and checked. The zero test output on the accounting machine emits if a discrepancy is found between the original and recalculated amounts.

WIRING (FIGURE 83)

1. Other + incentive earnings is readout from the 605 COUNTER EXITS through normal CO-SELECTOR 35 and transferred CO-SELECTOR 23 to COUNTER 4D ENTRY. This amount was read from code 2 and code 3 cards at SECOND READING and used in the original and recalculated gross pay calculations. It is now being stored in a 412 counter for future comparison against the same field read from THIRD READING.
2. Gross pay is read out of gs2 through various selectors of section one diagrams to print. This diagram shows gross pay at CO-SELECTOR 27. It is wired through transferred CO-SELECTOR 33 to COUNTER 8A ENTRY. COUNTER 8A develops the second checking formula by adding gross pay, subtracting deductions and net pay to arrive at a zero balance. See Figure 74 also.
3. Regular hours and overtime hours (from third read) are read into FS 1 and 3 respectively. See Figure 70, 71 also.
4. On cycle 1, rate was stored in counter 4B and tax class was stored in counter 2D. On cycle 3, the counters readout these factors through transferred CO-SELECTOR 34 to FS4. Tax class is stored

in the high order position of FS4. See Figure 71 also.

5. Counter 4B and 2D are caused to read out and reset by an ALL CYCLES impulse through SELECTORS to the COUNTER TOTAL HUB. See Figure 79 also.
6. COUNTER 8A AND 4D PLUS are impulsed through PILOT SELECTOR 28 from CARD CYCLES (see Figure 74 also).
7. FS 3 RI hub is impulsed from 10 COMMON hub on this cycle. See Figure 70 also.

605 Planning Chart (Figures 73A and 73B)

PROGRAM EXITS B 1-60 are active.

1. Gross pay is checked on program steps B3-17. Base wages and overtime are recalculated and combined with other earnings to form a recalculated gross. This amount is in the counter on step 15. On step 16 the original gross (stored in gs2) subtracts from the recalculated gross. Step 17 zero tests and resets the counter.
2. Steps 18 and 19 separate tax-class-code from the rate (FS4) and transfers it to a smaller storage unit, FS1.
3. Steps 31-40 recalculate withholding tax. Steps 41 and 42 subtract the original withholding tax (stored in gs4) from the recalculated tax and zero test.
4. Steps 43-53 recalculate FICA and store it in FS1.
5. Steps 58-59 accumulate the checked withholding tax and recalculated FICA in the counter for readout to COUNTER 8A.
6. Step 60 transfers FICA YTD for readout to the accounting machine where it will be compared against FICA YTD from THIRD READING.

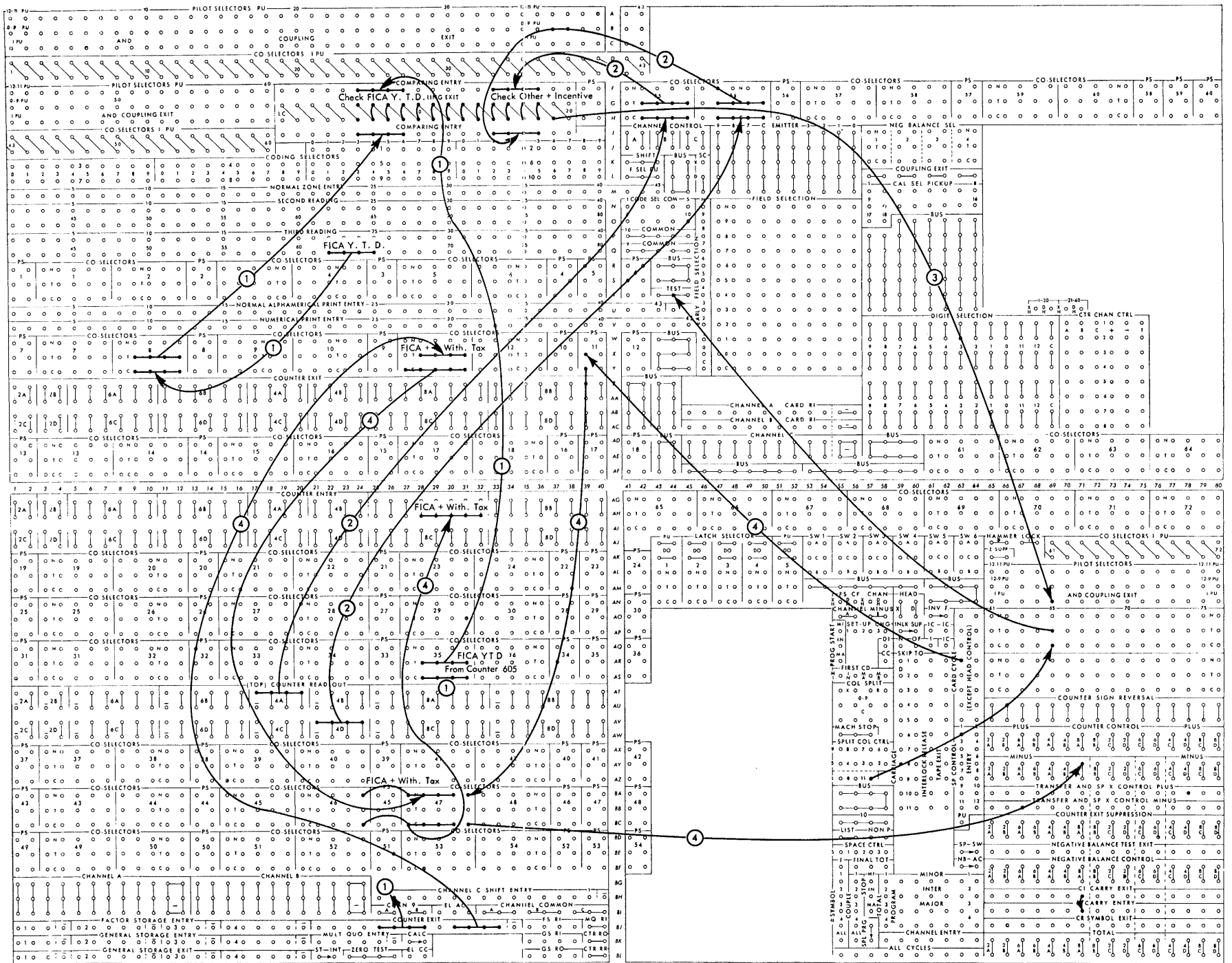

FIGURE 84: CHECKING: CYCLE 4

Checking, Cycle 4 (Figure 84)

On cycle 4 the YTD card passes third reading. FICA YTD used in the FICA calculation is compared against FICA YTD from third reading. Withholding tax and FICA are subtracted from gross pay in counter 8A. Other + incentive earnings is also checked in the comparing unit. The calculator is not used for checking on this cycle.

WIRING

1. FICA YTD is wired from THIRD READING through transferred CO-SELECTOR 8 to COMPARING ENTRY. The FICA YTD used in the calculation of FICA is read out from the 605 COUNTER through transferred CO-SELECTOR 35 to COMPARING ENTRY. Thus any discrepancy between the FICA YTD used in the calculation and FICA YTD read from another reading station will result in a COMPARING EXIT impulse. See Figure 83 also.
2. COUNTER 4A accumulated other and incentive earnings from THIRD READING. COUNTER 4D contains the other + incentive earnings used in the calculation of gross pay. These amounts are checked by wiring from TOP COUNTER READOUT through CO-SELECTORS to the COMPARING UNIT.
3. COMPARING EXIT is wired through transferred PILOT SELECTOR 65 to the TEST hub. This will cause the machine to stop if an error in FICA YTD or other + incentive earnings is found.
4. Withholding tax + FICA is read out from 605 COUNTER EXITS through CO-SELECTORS to COUNTER 8A ENTRY. CARD CYCLES is wired through PILOT 11 and CO-SELECTOR 47 to COUNTER 8A MINUS.

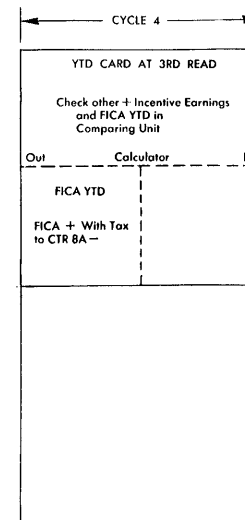

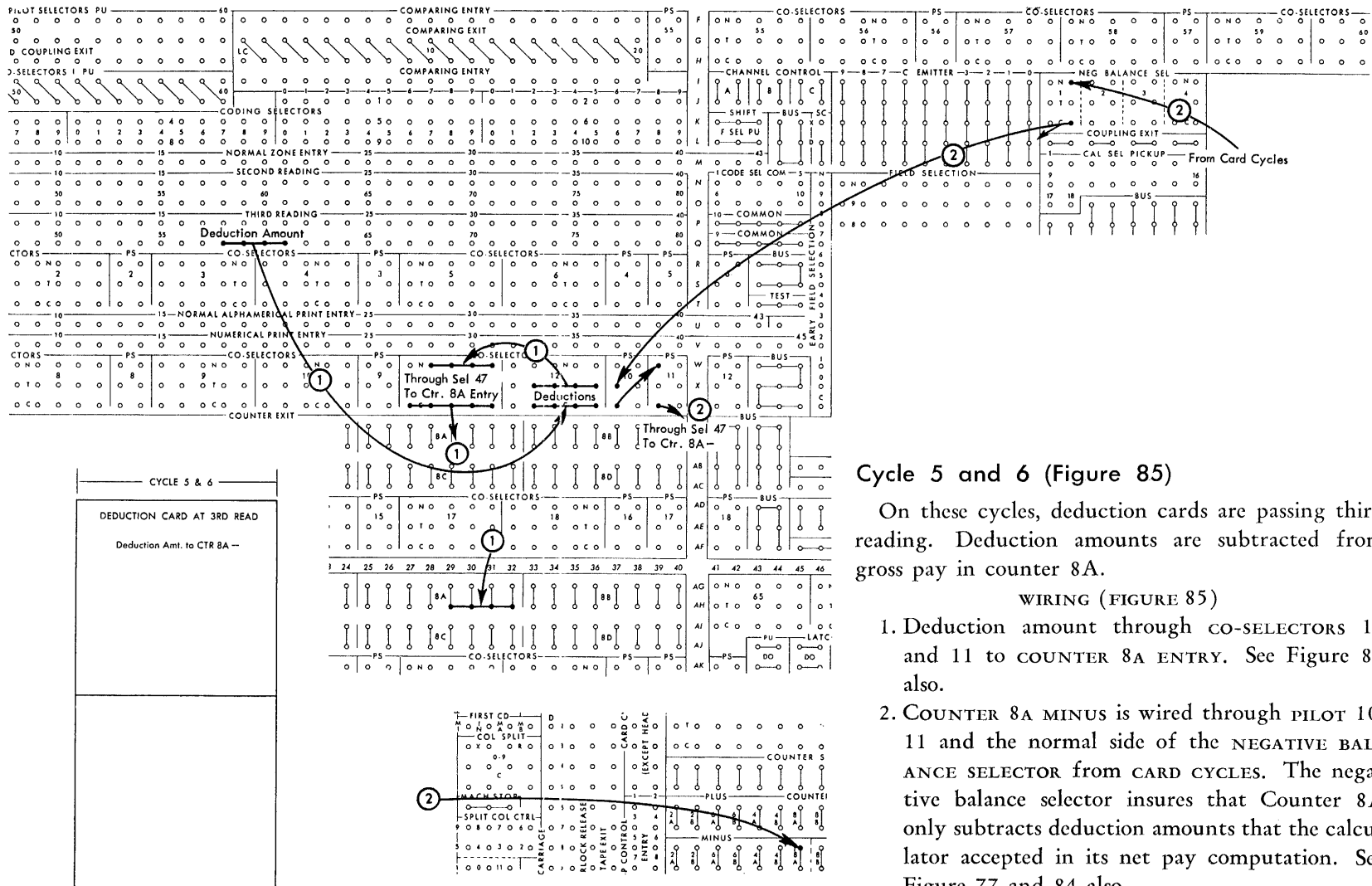

FIGURE 85. CHECKING CYCLES 5 AND 6

Cycle 5 and 6 (Figure 85)

On these cycles, deduction cards are passing third reading. Deduction amounts are subtracted from gross pay in counter 8A.

WIRING (FIGURE 85)

1. Deduction amount through CO-SELECTORS 12 and 11 to COUNTER 8A ENTRY. See Figure 84 also.
2. COUNTER 8A MINUS is wired through PILOT 10, 11 and the normal side of the NEGATIVE BALANCE SELECTOR from CARD CYCLES. The negative balance selector insures that Counter 8A only subtracts deduction amounts that the calculator accepted in its net pay computation. See Figure 77 and 84 also.

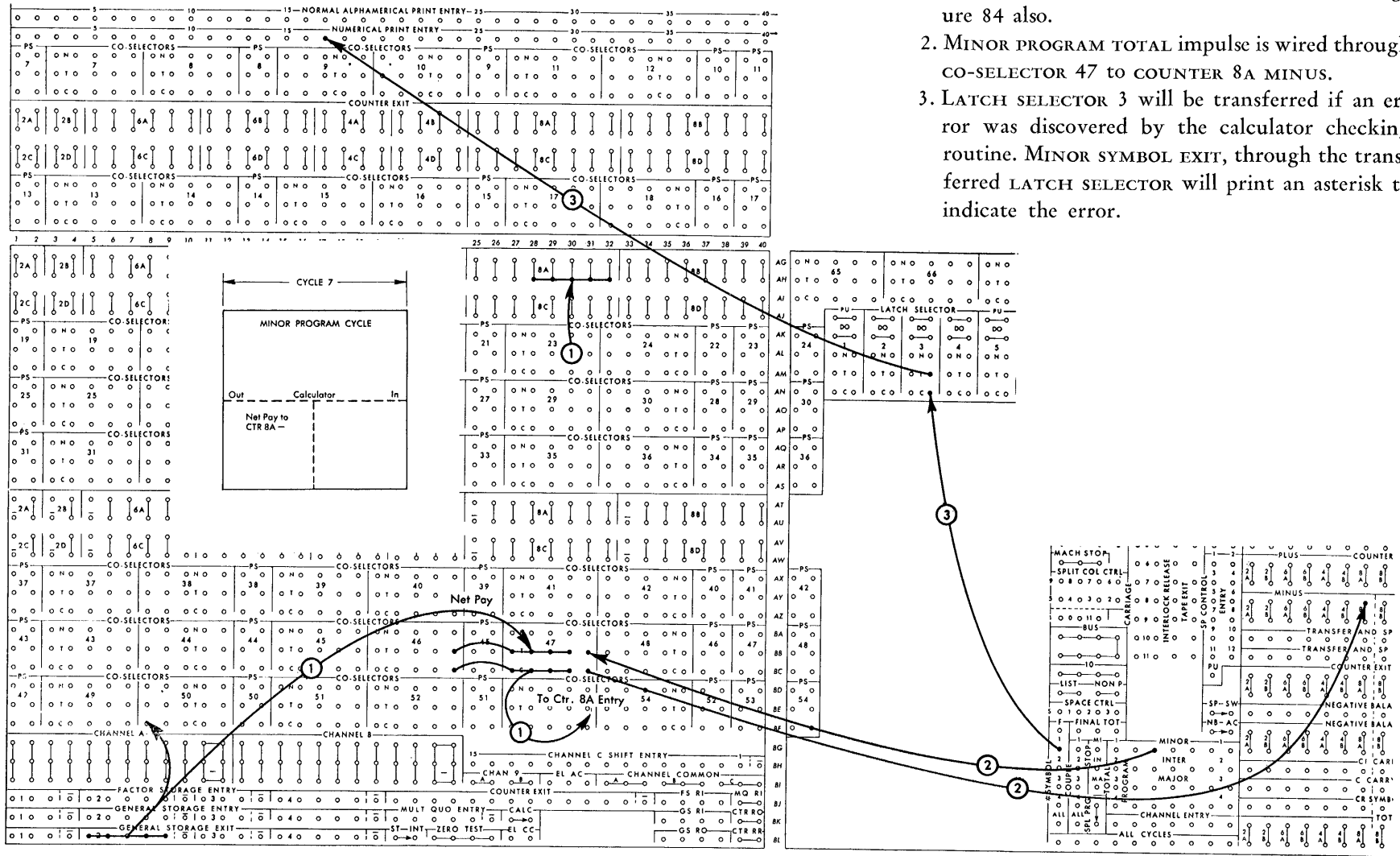

Cycle 7 (Figure 86)

On the minor program cycle (Figure 86) net pay is subtracted in counter 8A.

Wiring:

1. Gs2 exits read out net pay through transferred CO-SELECTOR 47 to COUNTER 8A ENTRY. See Figure 84 also.
2. MINOR PROGRAM TOTAL impulse is wired through CO-SELECTOR 47 to COUNTER 8A MINUS.
3. LATCH SELECTOR 3 will be transferred if an error was discovered by the calculator checking routine. MINOR SYMBOL EXIT, through the transferred LATCH SELECTOR will print an asterisk to indicate the error.

FIGURE 86. CHECKING: CYCLE 7, MINOR PROGRAM

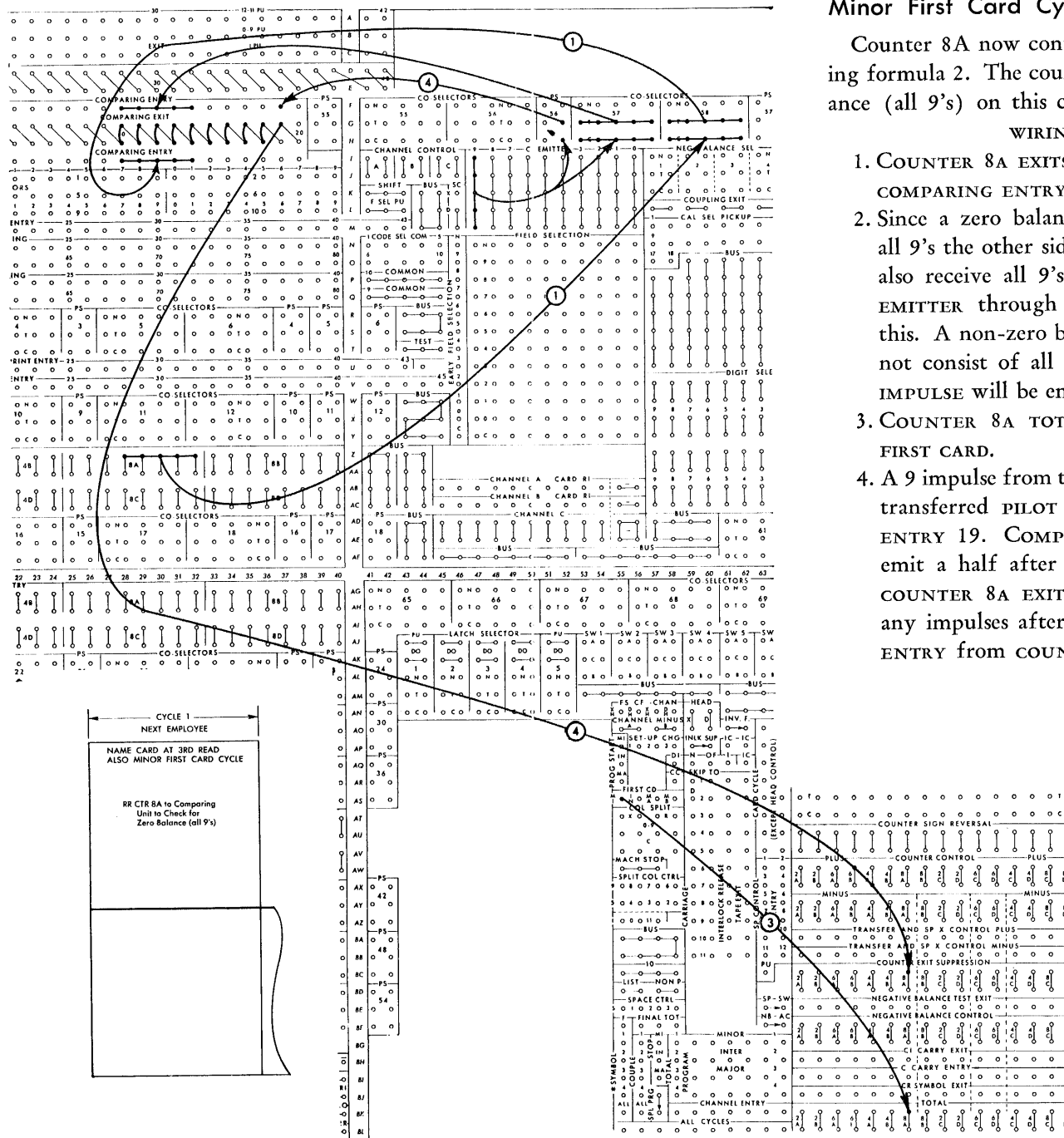

Minor First Card Cycle (Figure 87)

Counter 8A now contains all the factors of checking formula 2. The counter is checked for a zero balance (all 9's) on this cycle.

WIRING (FIGURE 87)

1. COUNTER 8A EXITS through CO-SELECTOR 58 to COMPARING ENTRY.
2. Since a zero balance in the counter consists of all 9's the other side of COMPARING ENTRY must also receive all 9's. Emitted nines from the C EMITTER through CO-SELECTOR 57 accomplish this. A non-zero balance from COUNTER 8A will not consist of all nines and a COMPARING EXIT IMPULSE will be emitted to stop the machine.
3. COUNTER 8A TOTAL is impulsed from MINOR FIRST CARD.
4. A 9 impulse from the C EMITTER is wired through transferred PILOT SELECTOR 56 to COMPARING ENTRY 19. COMPARING EXIT, position 19, will emit a half after 9 impulse which is wired to COUNTER 8A EXIT SUPPRESSION. This prevents any impulses after 9 from reaching COMPARING ENTRY from COUNTER EXIT HUBS.

FIGURE 87. CHECKING: MINOR FIRST CARD CYCLE

TYPE 527 CONTROL PANEL



O, 21-22

Delay PU

Independent use of the 527 and 605 machines occasionally requires an extension of calculate time to prevent an unfinished program signal. The DELAY PU feature can be wired to cause the punch to wait until calculation in the 605 is completed. Two single entry hubs are provided, and either will accept a digit 12-8 impulse. Normally an X from the card requiring extended calculation is wired to these hubs.

½ Time Emitter

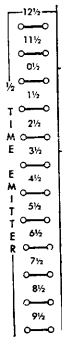

The HALF TIME EMITTER emits impulses halfway between digit impulses. For example, the 4½ hub emits at half after 4 time. They are normally wired to selector pickup to cause the selector to operate as a column split.

O-Z, 23-24

SUMMARY PUNCH CONTROL

A SUMMARY PUNCH operation can be initiated from many sources. Two examples of causing a summary punch cycle are shown on Figure 88. The first method shows card control of SP PU. This method causes the summary punch cycle to occur after the X79 card has passed third reading. Thus the summary card can be punched with amounts read from that card at third reading into 412 counters. The summary card can also be punched with 605 calculator results which are calculated from fields read from the X79 card when it passed third reading. This method causes summary punching for consecutive X79 cards as well as for occasional X79 cards in a deck.

The second method shown punches a summary card before the minor program and another before the intermediate program cycle.

Wiring (Figure 88)

1. X79 from SECOND READING to PILOT SELECTOR 12-11 PICKUP. A 12 impulse from the DI hub and DIGIT SELECTOR is wired through the transferred pilot selector to SP PU. The 12 impulse insures that summary punching occurs if the X79 cards are consecutive.
2. MINOR and INTERMEDIATE PROGRAM are split wired to SUMMARY PUNCH PU.

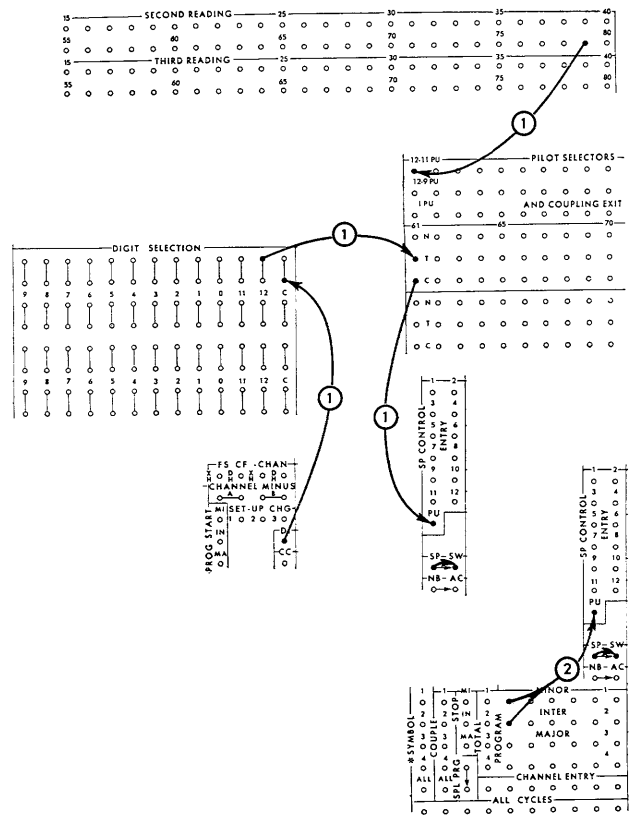

FIGURE 88. SUMMARY PUNCH CONTROL

AUTOMATIC ADVANCE OF FIELD SELECTOR LEVELS

THE FIELD SELECTOR may be set up to automatically advance from one level to the next on succeeding machine cycles. This is particularly valuable on applications requiring special program cycles. The automatic advance of the field selector coincides with successive special program cycles to control calculator read-in fields, 941 storage read-out, 412 counter read out, or calculator output results.

The wiring for field selector pickup control is shown on Figure 89. This automatic advance of the field selector can also be adapted to card control by selecting the starting impulse (digit 1) in a different manner than shown. The field selector is in the normal level on special program cycle 1. It is in the 1 level on special program cycle 2, the 3 level on cycle 4, etc.

Wiring (Figure 89)

1. SPECIAL PROGRAM SWITCH is jackplugged. SPECIAL PROGRAM STOP wiring is not shown.
2. On special program cycle 1 CHANNEL ENTRY and PROGRAM LEVEL 1 hub are connected. The emitted digit 1 impulse is wired through this connection to the normal of the FIELD SELECTOR, first position. Since the field selector is in the normal level, the digit one comes out of the first position C hub and impulses FIELD SELECTOR PICKUP. This causes the field selector to go to level 1 on the second special program cycle.
3. On special program cycle 2 a digit 2 is wired to the LEVEL 1 hub. It causes the F SEL PU hub to receive a 2 impulse. This will place the field selector in level 2 on the next special program cycle. Digits 3-5 cause successive advance of the field selector on following cycles.

The FIELD SELECTOR will return to the normal level on the cycle following the one in which it failed to receive a digit impulse at its pickup hub.

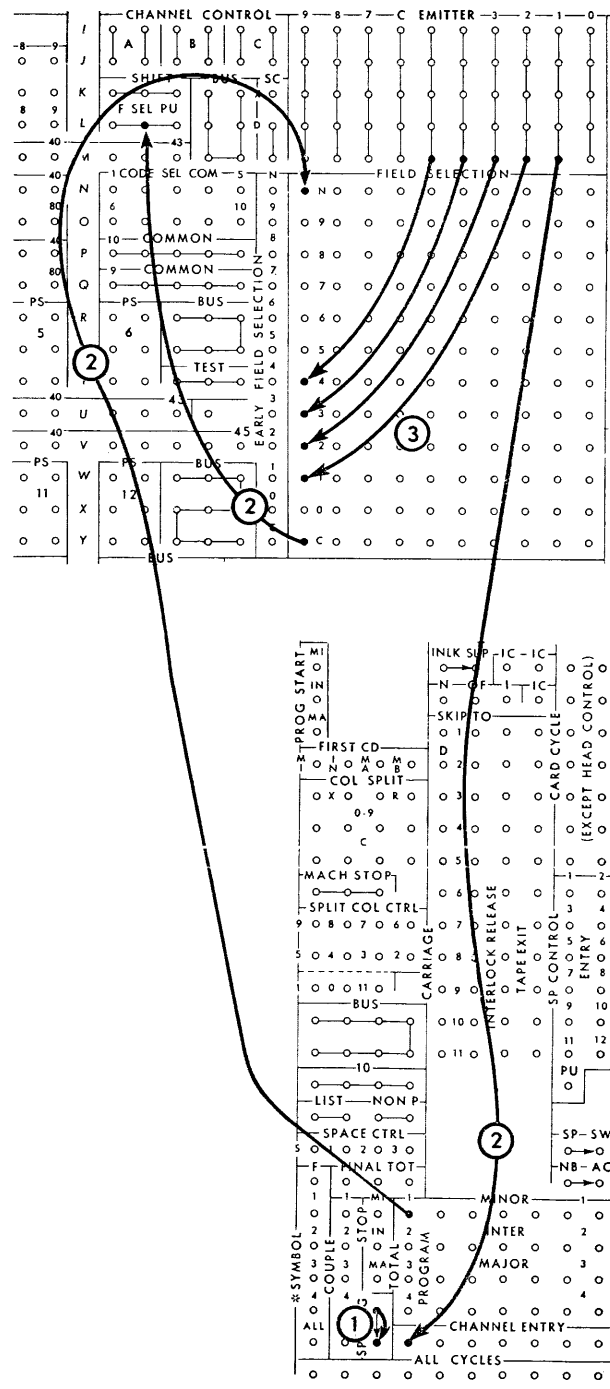

FIGURE 89. AUTOMATIC ADVANCE OF FIELD SELECTOR LEVELS

GENERAL PURPOSE SETUP OF THE CPC

COMPUTING applications of the CPC often use a general purpose setup of control panels. Such a setup makes the CPC an ideal machine for the solution of a variety of problems without altering the control panel. Many types of general purpose control panels exist which differ only in details, but all follow the same general pattern. The basic principles of this pattern are outlined in this section and shown on Figure 90. Detailed descriptions of general purpose control panels are available in *Applied Science Technical Newsletters*.

Basic Outline of General Purpose Setup

1. The 605 calculator is wired to give it the ability to perform a number of mathematical operations. These operations are called for, as required, by codes punched in instruction cards.
2. One channel is formed to enter factors into 941 registers or 412 counters from the card or the calculator. This is called CHANNEL C.
3. Two channels are formed to read out of 941 storage registers and 412 counter groups into the 605 calculator factor storage entry. These channels are called CHANNEL A and CHANNEL B.
4. 412 counter groups are connected to these channels through a selector chain on the control panel. Sign control for positive, negative and complement numbers is included in this selector chain.
5. Storage registers and 412 counter groups are addressable from coded instructions punched in cards.

Thus by standardizing control panel wiring and instruction codes the CPC is card programmed to solve a variety of problems expressed in mathematical form by proper punching of instruction and data cards.

The CPC is equipped with many control panel features that are installed on the machine to facilitate wiring of the general purpose setup. Several of these, not previously explained, are included in this section.

Counter Channel Control

COUNTER CHANNEL CONTROL hubs are exit hubs which are wired to control 8 counter groups. Each row controls a separate counter group. The pattern of impulses emitted by a row of hubs depends on the coded instruction received by CHANNEL CONTROL

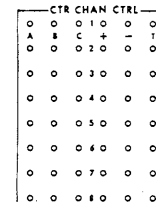

V-AC, 70-75

hubs (I-J, 41-46). CHANNEL CONTROL accepts codes 11-66 to control 941 storage registers. Codes 71-88 are reserved for 412 counter control and determine the output from the CTR. CHAN. CTRL. hubs. These codes and their meaning are listed as follows:

COUNTER GROUP	CHANNEL A, B CODES		CHANNEL C CODES	
1	71 RO	81 RO RR	71 ADD	81 SUBT
2	72 RO	82 RO RR	72 ADD	82 SUBT
3	73 RO	83 RO RR	73 ADD	83 SUBT
4	74 RO	84 RO RR	74 ADD	84 SUBT
5	75 RO	85 RO RR	75 ADD	85 SUBT
6	76 RO	86 RO RR	76 ADD	86 SUBT
7	77 RO	87 RO RR	77 ADD	87 SUBT
8	78 RO	88 RO RR	78 ADD	88 SUBT

The A, B, C hubs are wired to CO-SELECTOR PICK-UP. The + to COUNTER PLUS; the - to COUNTER MINUS; the T to COUNTER TOTAL hubs. Thus a 71 code received by CHANNEL A CONTROL causes the A, +, T, hubs of row 1 of CTR. CHAN. CTRL to emit. These hubs are then wired to cause COUNTER group 1 to RO on CHANNEL A. The A hub is wired to the CO-SELECTOR pickup which connects COUNTER EXITS to the CHANNEL A chain. The + hub is wired to COUNTER group 1 PLUS CONTROL and the T hub to COUNTER TOTAL. A 72 code received by CHANNEL A CONTROL causes row 2 hubs to emit in the same pattern for controlling COUNTER group 2. An 81 code causes the A, T, hubs to emit, reading out and resetting the counter.

CHANNEL B CONTROL accepts codes in the same manner except that the B hub of CTR CHAN CTRL emits instead of the A hub. This is wired to the selector pickup to connect COUNTER EXITS into the CHANNEL B chain.

CHANNEL C CONTROL accepts codes 71-88 to cause counter addition and subtraction. A code 71 causes

the c, + hubs to emit. The c hub is wired to CO-SELECTOR pickup which connects COUNTER ENTRY hubs to CHANNEL C. An 81 code causes COUNTER group 1 to subtract the amount on CHANNEL C.

Thus card punched instruction codes automatically cause 412 counters to add, subtract, readout, or readout and reset.



AU-AV, 65-80

Counter Sign Reversal

COUNTER SIGN REVERSAL provides automatic sign control for negative amounts added or subtracted into 412 counter groups. COUNTER SIGN REVERSAL hubs accept a negative sign impulse from 605 COUNTER EXIT or 412 COUNTER CR SYMBOL EXIT to reverse the plus or minus control of 412 counters. A double hub is provided for each counter group. It is normally wired from the CHANNEL C SIGN chain.

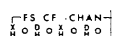

AN, 57-58

Card Feed Channel

CARD FEED CHANNEL CONTROL HOLD causes the instruction codes accepted by CHANNEL CONTROL HUBS (1J, 41-46) to be effective on the next card cycle. Without this feature instruction codes are normally active on the next machine cycle, regardless if it is a total or card cycle. An x hub and a DIGIT PICKUP hub are provided. Thus this feature holds the channel instruction codes until the first card cycle following program cycles.



BI, 25-28

Channel 9

The CHANNEL 9 hubs emit a 9 impulse whenever a complement number is being sent over its respective channel. It is normally wired to fill up high order positions of 605 storage units or 412 counters which are receiving a complement number.



Q, 41-45

9 Common

These hubs emit a 9 impulse on every active machine cycle that cards are in the machine.

Wiring (Figure 90)

1. This wiring identifies the CHANNEL A chain. The triple hubs of CHANNEL A (941 Readout hubs) serve as a focal point. 412 counters are arranged in 7 groups. The COUNTER EXITS are wired through the transferred side of their respective selectors to CHANNEL A. CHANNEL A is also wired to 605 STORAGE ENTRY and to NUMERICAL PRINT ENTRY. CHANNEL A SIGN wiring is incomplete as shown, however, in practice it would be wired to handle negative or complement numbers or both.
2. The CHANNEL B chain is wired similar to the CHANNEL A chain. Note that 412 COUNTER EXITS are split wired to both CHANNEL A and B.
3. The 605 COUNTER EXIT HUBS are wired through the CHANNEL C SHIFT ENTRY to CHANNEL C. These 605 results are then read into 941 storage registers or through transferred selectors to 412 COUNTER ENTRY. COUNTER SIGN REVERSAL hubs are wired into the selector chain to properly handle negative numbers being read into 412 counters.
4. Factors from the card are read into the 605 calculator directly through CHANNEL A CARD RI hubs. CHANNEL B CARD READIN performs a similar function for CHANNEL B. CHANNEL MINUS accepts an X which identifies a negative number read from the card. The CHANNEL A CARD READIN and CHANNEL MINUS are entries from the card when a O instruction has been received by the CHANNEL CONTROL hubs.
5. Instruction codes from the cards are wired to CHANNEL CONTROL and to SHIFT PICKUP. Note that CHANNEL A AND B instructions are wired from SECOND READING. CHANNEL C instructions and SHIFT pickup are wired from THIRD READING. The instruction codes are printed by wiring to PRINT ENTRY.
6. COUNTER CHANNEL CONTROL wiring shows selector and counter control for COUNTER group 7. The other 6 counter groups would be similarly wired to the first 6 rows of CTR CHAN CTRL.
7. CHANNEL B 9 is wired to fill up the high order position of gs3 if a complement number is sent over CHANNEL B.

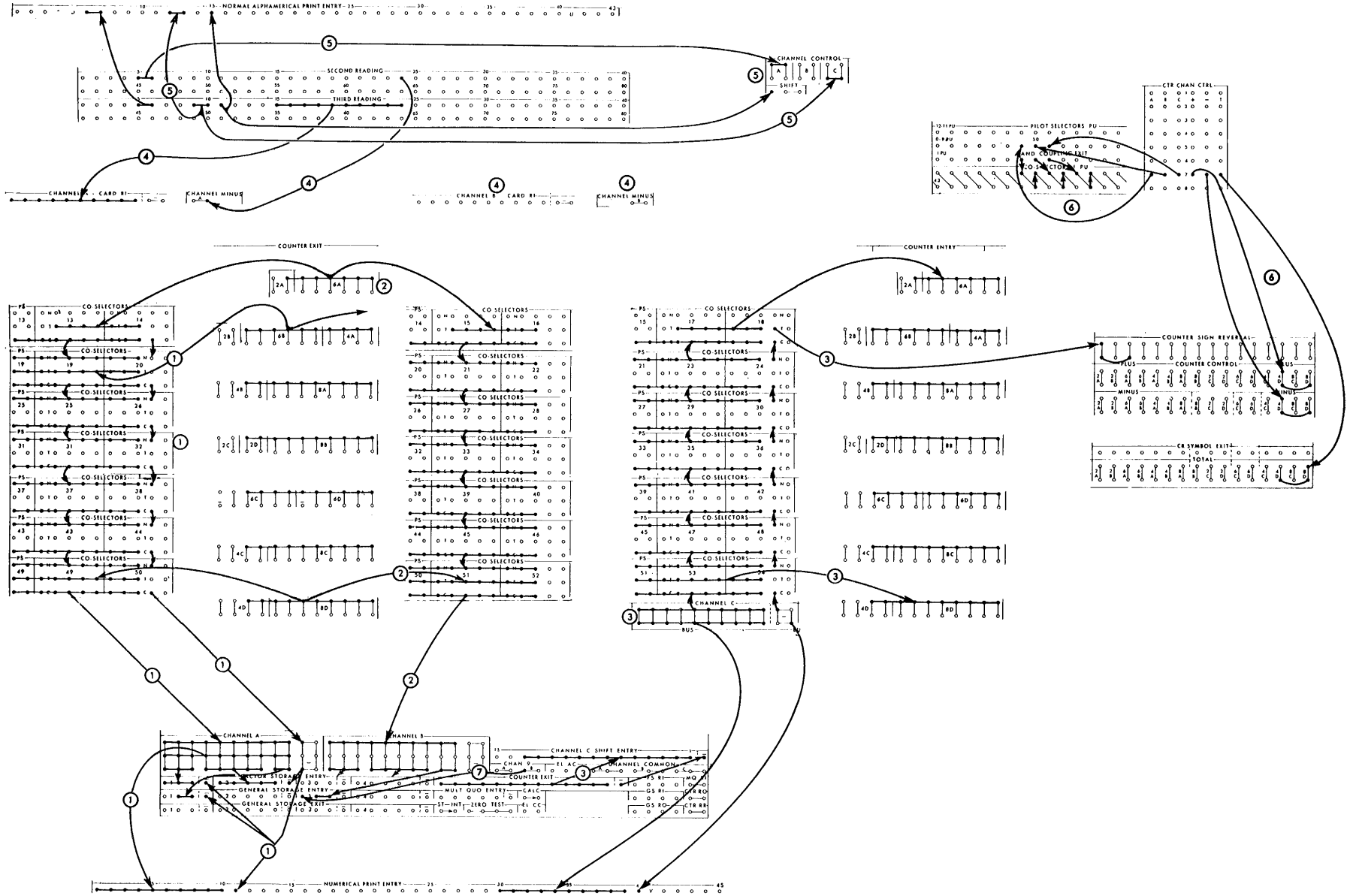

FIGURE 90. GENERAL PURPOSE SETUP

SIGN CONTROL SUMMARY

READING INTO THE 605

From 412-418 Counter Exits

1. *Net Balance Operation.* Wire from the **NEGATIVE BALANCE TEST EXIT** to the corresponding **NEGATIVE BALANCE CONTROL HUB**. This will cause a complement number standing in the counter to convert to a true negative figure. Wire from the **CREDIT SYMBOL EXIT** of the counter to the channel sign entry to operate sign control on the 605.

2. *Non-Net Balance Operation.* Wire from the **NEGATIVE BALANCE TEST EXIT** to the channel sign entry. This will operate sign control on the 605 and cause automatic inversion of a complement number to a negative number in the 605.

From 412-418 Top Counter Read-Out

1. Wire from the **NEGATIVE BALANCE TEST EXIT** of the counter group to the transferred side of the selector used for gating **TOP COUNTER READ-OUT** onto **CHANNELS A OR B**. Wire from the corresponding common hub of the gating selector to the channel sign entry. The **NEGATIVE BALANCE TEST EXIT** may be split-wired for read-out on both **CHANNELS A** and **B**. It may also be split-wired to **NEGATIVE BALANCE CONTROL**. **NBAC** (negative balance all cycles) must be wired on. This method of sign control with top counter read-out may therefore be used when the counter exits on the same control panel are wired for net balance operation.

2. Another method of obtaining sign control with top counter read-out makes use of a 258° impulse which is emitted from the high order counter position whenever a complement number stands in the counter. This impulse operates sign control on the 605 and causes automatic inversion of a complement number in the 605. Wire from the high order counter position of **TOP COUNTER READ-OUT** to the common of a selector that is picked up by means of a hot ten impulse to its immediate pickup. The purpose of this selector is to prevent sign control in the 605 from being operated by a digit impulse emitted from **TOP COUNTER READ-OUT** when the counter is positive. This same selector may be used for more than one counter group. Wire from the normal hub of the selector to the transferred side of the selector used for gating **TOP COUNTER READ-OUT** onto **CHANNELS A OR B**. Split-wire for read-out on both **CHANNELS A** and

B. Wire from the common of the gating selector to channel sign entry as under 1 above.

This method of sign control with **TOP COUNTER READ-OUT** is not affected by the **NBAC** switch. The method may therefore be used in conjunction with either net balance or non-net balance operation from the counter exits.

From the 941

Wire from the channel sign hub to the sign hub of the 605 unit being entered. When a true negative number is being transferred, the channel **A** or **B** sign hubs emit a 282° impulse which operates sign control in the 605. When a complement number is being transferred, the **CHANNEL A** or **B** sign hubs emit a 258° impulse as well as a 9 impulse. This operates both inversion and sign control in the 605.

From 412-418 Card Reading

Wire from **SECOND READING** to the 12-11 or **DIGIT PICKUP** of a **PILOT SELECTOR**, in accordance with the kind of punch used to denote a minus sign. Take a hot ten impulse through a transferred hub of this **PILOT SELECTOR** to the sign hub of the 605 storage unit to be entered.

READING INTO 412-418 COUNTERS

From 412-418 Counter Exits

1. *Net Balance Operation.* Wire from **NEGATIVE BALANCE TEST EXIT** to **NEGATIVE BALANCE CONTROL** to cause conversion. Also wire from **CREDIT SYMBOL EXIT** to **COUNTER SIGN REVERSAL**.

2. *Non-Net Balance Operation.* No sign reversal is necessary. Use normal wiring.

From 412-418 Top Counter Read-Out

No sign reversal is necessary. Use normal wiring.

From The 941

Wire from the **CHANNEL A** or **B SIGN** exit to **COUNTER SIGN REVERSAL**. When a true negative is being transferred, the **CHANNEL A** or **B** sign hubs emit a 282° impulse which operates counter sign reversal. When a complement number is being transferred, the signal to counter sign reversal is rejected.

From the 605

Wire from the 605 sign exit (or the CHANNEL C SIGN exit) to COUNTER SIGN REVERSAL.

From 412-418 Card Reading

Wire from SECOND READING to the 12-11 or DIGIT PICKUP of a PILOT SELECTOR, in accordance with the kind of punch used to denote a minus sign. Wire a CARD CYCLES or ALL CYCLES impulse (selected, if required) to the common of this PILOT SELECTOR. Wire from the normal of the PILOT SELECTOR to COUNTER CONTROL PLUS and from the transferred to COUNTER CONTROL MINUS of the 412-418 counter being entered.

READING INTO THE 941**From 412-418 Counter Exits**

1. *Net Balance Operation.* Wire from the CREDIT SYMBOL EXIT to the sign hub of CHANNEL C.
2. *Non-Net Balance Operation.* Wire from NEGATIVE BALANCE TEST EXIT to the sign hub of CHANNEL C.

From 412-418 Top Counter Read-Out

Wire from the high order counter position to the CHANNEL C SIGN entry. With TOP COUNTER READ-OUT, negative numbers will normally be transmitted in complement form. No provision has been made for the automatic conversion of a complement number from TOP COUNTER READ-OUT.

From the 941

Use normal wiring (from CHANNEL A or B sign to CHANNEL C sign).

From the 605

Wire from the sign exit of the 605 to the CHANNEL C sign entry.

From 412-418 Card Reading

Numbers are entered into the 941 by wiring from card reading to the CHANNEL C hubs. Entry is controlled by codes 11 to 18 and 21 to 28 in the channel C control field. Use an 11 punch in the card for the minus sign. Wire from SECOND READING directly to the CHANNEL C sign hub.

OPERATING SUGGESTIONS

SUMMARY OF STEPS FOR PLACING CPC IN OPERATION

1. Connect all cables between units and to the electric power supply. Cable connections are shown on Figure 1.
2. Put properly wired control panels in the 412-418, 527 and 605 machines.
3. Depress the 605 power-on-key.
4. Turn on the 527 main power switch.
5. Turn on the 941 main power switch.
6. Turn on the 412-418 main power switch.
7. About two minutes after the 605 start key has been depressed, see that the unlabeled green light is on.
8. Check to see that the 412-418 unlabeled light is on.
9. If the 412-418 light is on, press the non-print run-out button and let the 412-418 run for a few cycles to clear 412-418 and 605 circuits. This does not clear out 412-418 counters.
10. Put blank cards to be punched in the 527 card feed hopper. Push the start key two times to advance the first card to the punch station. (The 527 start key then has no control.)
11. The CPC is now ready for operation. Put cards in the hopper and depress the 412-418 start key. When two cards have entered, the 412 will continue running.

In operations where separate machine combinations are used (for example; 605-527 combination, or separate use of the 412 machine), the cables between the 412 and the 527 must be disconnected.

POWER SUPPLY CONNECTIONS

THE CPC requires only one power outlet. The power connections are as follows:

1. Connect the 605 power receptacle to the 220 V power supply outlet.
2. The 527 attachment power cord is plugged into an outlet on the 605 which is located adjacent to the 605 cable source.

3. The 412 attachment cord is inserted in an outlet provided on the 527 machine. This outlet is adjacent to the 412 to 527 cable connectors in the left end of the 527.
4. The 941 storage units have no power card. They receive their power through the cable connecting the 941 and 412 machines.

BLANK CARD IN 412-418 CARD FEED

CPC operations require that a blank card be placed behind the last card of a deck in the 412-418 feed. This blank card insures that calculation will be performed from fields read at third reading station of the last active card.

605 CONTROL PANEL WIRING

605 CONTROL PANEL wiring falls into 2 categories:

1. PROGRAM PICKUP, STORAGE ASSIGNMENT, CALCULATOR COUPLING EXIT, and PROGRAM SOURCE WIRING.
2. Electronic functions, such as PROGRAM EXIT, COUNTER and STORAGE READ-IN and READ-OUT, REPEAT SELECTOR PICKUP, etc.

Control panel wiring cannot be intermixed between these two categories. That is, wiring of electronic functions must be confined to category two sources.

PROGRAM PICKUP, etc. must be wired from PROGRAM SOURCE or other category one hubs. This also applies to components, such as PROGRAM SOURCE FILTERS, which are designed expressly for use in category one circuits and cannot be used with electronic circuit functions.

For convenience of reference, 605 entry and exit hubs have been listed below in two classes. The first consists of all hubs associated with category one circuits in the machine; the second is composed of all hubs associated with electronic circuits in the machine. It is important that no control panel wire shall connect a hub in one class to any hub in the other class.

Hubs That May NOT Be Used in Electronic Circuits

Exits:

1. PROGRAM SOURCE
2. STORAGE ASSIGNMENT (exit)
3. COUPLING EXITS of calculator selectors
4. OUT hubs of PROGRAM SOURCE FILTERS

Entries:

1. PROGRAM PICKUP
2. STORAGE ASSIGNMENT (inlet)
3. IN hubs of PROGRAM SOURCE FILTERS

Hubs That May Be Used ONLY in Electronic Circuits

Exits:

1. PROGRAM EXITS
2. SUPPRESS WITHOUT TEST
3. SUPPRESS ON PLUS
4. SUPPRESS ON MINUS
5. SUPPRESS ON ZERO
6. SUPPRESS ON NON-ZERO
7. GROUP SUPPRESSION EXITS
8. PROGRAM EXPANSION OUT
9. SUPPRESSION FILTER OUT

Entries:

1. All function hubs, including FACTOR and GENERAL STORAGE READ-IN and READ-OUT, READ UNITS INTO or OUT OF, MULTIPLY PLUS or MINUS, COUNTER READ-IN PLUS or MINUS, COUNTER READ-OUT and RESET, COUNTER RESET, DIVIDE, MULTIPLIER-QUOTIENT READ-IN or READ-OUT, HALF ADJUST, PROGRAM REPEAT, REPEAT DELAY PICKUP or DROP-OUT, EMIT 1 through 9, GROUP SUPPRESSION PICKUP or DROP-OUT, ZERO TEST, BALANCE TEST FOR SELECTOR PICKUP
2. PROGRAM SUPPRESSION ENTRY
3. PROGRAM REPEAT SELECTOR PICKUP
4. PROGRAM EXPANSION IN
5. SUPPRESSION FILTER IN

CHANNEL SHIFT is normally used in electronic circuits, however, it may be used in category one wiring, but not in both categories on the same control panel.

Wiring of 605 and 412-527 Exits

EXIT hubs of the electronic counter and general storage units are on the 412 and on the 527 control panel. These exit hubs are connected to a different power supply than the standard accounting machine and summary punch control panel hubs. Therefore, these 605 exit hubs should not be split wired with a 412 or 527 exit hub to the same magnet. For example: a 412 COUNTER EXIT should not be split wired with a 605 COUNTER EXIT to the same COMPARING ENTRY hub. Nor should the 605 GENERAL STORAGE EXIT be split wired with a 412 COUNTER EXIT to DPBC ENTRY on the 527 control panel. Electronic exit hubs can be wired to the same entry hubs as 412 counter exit hubs provided selectors are used which prevent the read-out of both of these units on the same cycle.

PROGRAM SOURCE FILTERS

It is generally assumed that a filter allows current to go in only one direction—from IN to OUT—and thus may be used to eliminate back circuits. Filters, however, do not entirely eliminate back circuits. A little current passes in the opposite direction—from OUT to IN—but so little that the reverse current cannot operate any feature of the machine. Also, as current passes through a filter, there is a slight loss of power.

To eliminate back circuits for purposes other than those for which filters were originally intended, selectors should be used whenever possible, as improper use of filters will not only cause improper machine operation but may also damage the filters.

Figure 91 shows four examples which illustrate the correct method of wiring filters for typical applications. Also shown are the incorrect methods for these same applications.

Example 1

If an impulse is wired through a program source filter to operate one feature of the machine, then this same impulse must also pass through another program source filter if it is to operate another feature simultaneously.

Impulse A controls PROG PU 16-21, 22-24.

Impulse B controls PROG PU 22-24.

Impulse A must be wired through a filter to each of the two groups of PROG PU control hubs.

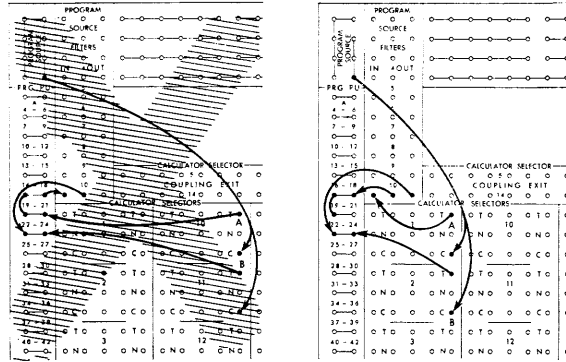

1a. Incorrect

1b. Correct

Example 2

An impulse must not pass through more than one program source filter in series to control any feature of the machine. This means that an impulse from the OUT of one filter must not be wired to the IN of another filter.

Impulse A is incorrectly wired to two PROG PU hubs through two filters in series in example 2a.

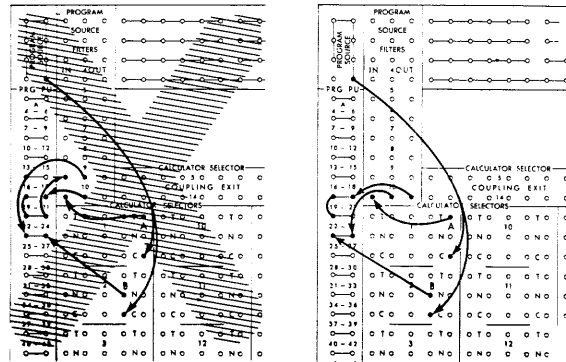

2a. Incorrect

2b. Correct

Example 3

Split wiring through program source filters should not be used when such wiring puts two or more reverse current paths in parallel. The combination of the reverse currents may be sufficient to cause erroneous operation of a machine feature. In example 3, the split wiring from the T hub of calculator selector 1 causes the reverse currents from the pickups of programs 22-24 and 25-27 to be combined. The reverse current paths are indicated by arrows. The combined reverse currents may be sufficient to interfere with normal operation of PROGRAM PICKUP 19-21, especially if several program pickups are impulsed simultaneously through calculator selectors 2 and 3.

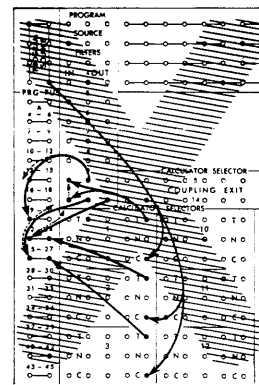

3. Incorrect

Example 4

A filter is designed to take a certain load of electricity which, if exceeded, will damage the filter and may cause the machine to operate improperly. Each PROGRAM SOURCE FILTER OUT hub can be wired to a maximum of four PROG PU hubs.

Example 4a is incorrect. Wire A is connected to more than 4 PROG PU hubs. Correct wiring is shown on example 4b (wires A) where two filters are wired in parallel; each OUT hub is connected to only 4 PROG PU hubs.

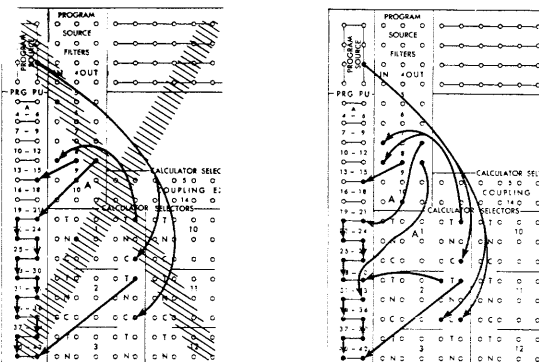

4a. Incorrect

4b. Correct

FIGURE 91. PROGRAM SOURCE FILTERS

CALCULATOR SELECTOR COUPLING EXIT (Used as an Entry Hub)

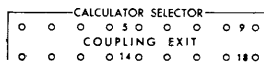

I-J, 6-14

NORMALLY calculator selectors are picked up from the 412-418 control panel. It is possible to transfer a calculator selector during calculate time by impulsing its COUPLING EXIT through REPEAT SELECTOR wiring. The COUPLING EXIT is an entry hub for picking the selector but as soon as the selector transfers the COUPLING EXIT emits a continuous impulse. Thus a PROGRAM SOURCE FILTER must also be used to prevent a back circuit between PROGRAM SOURCE and COUPLING EXIT.

Wiring (Figure 92)

1. PROGRAM REPEAT, REPEAT DELAY, and REPEAT SELECTOR 1 PU are wired from PROGRAM EXIT hubs. This causes REPEAT SELECTOR 1 to transfer during the repeat delay period.
2. CALCULATOR SELECTOR 2 COUPLING EXIT is impulsed from PROGRAM SOURCE through REPEAT SELECTOR 1 and PROGRAM SOURCE FILTER.

Calculator Selector Coupling Exits (Used as Exits)

Impulses available from the COUPLING EXITS of calculator selectors must not be passed through the hubs of repeat selectors to control the pickup of program levels. Only PROGRAM SOURCE impulses may be used in this manner. The COUPLING EXIT impulse is continuous and consequently damages selector points when repeat selectors are picked up or dropped out.

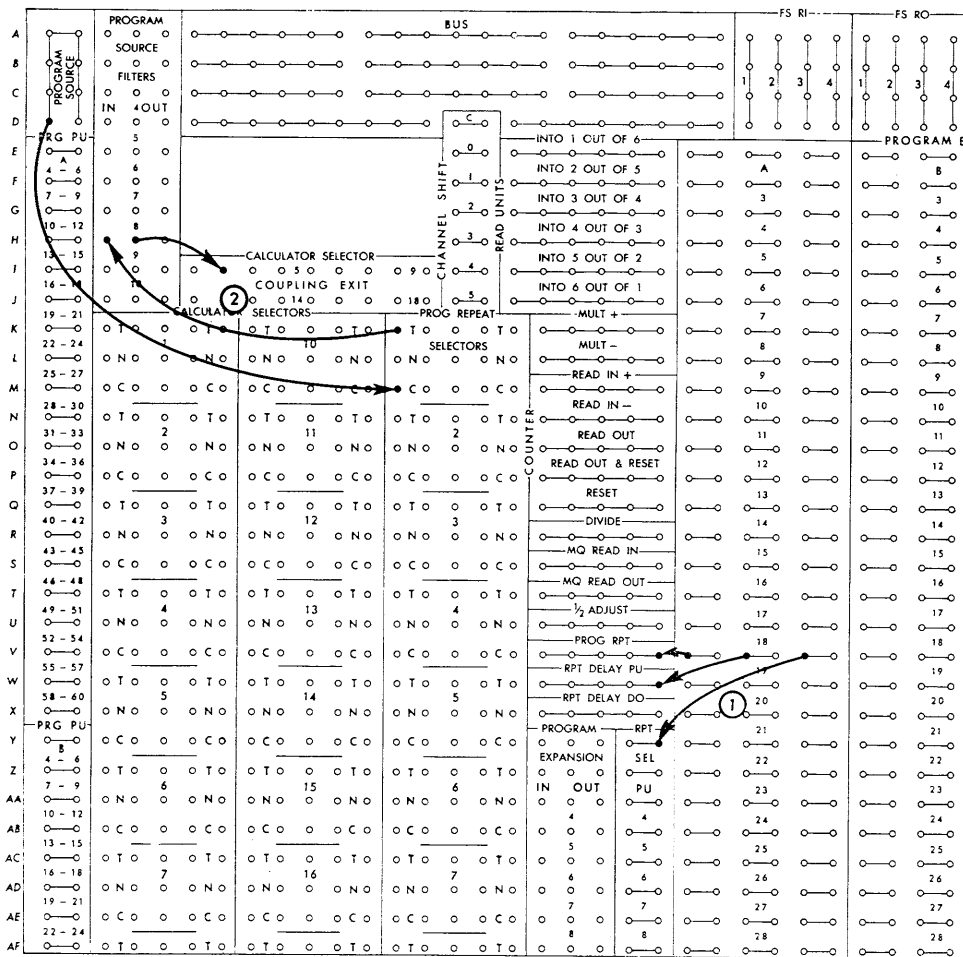

FIGURE 92. CALCULATOR SELECTOR COUPLING EXIT

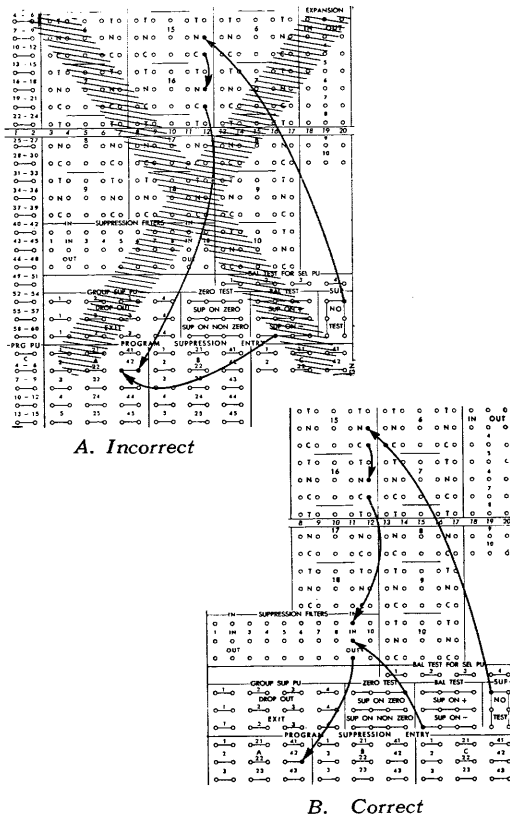

FIGURE 93. PROGRAM SUPPRESSION

PROGRAM SUPPRESSION

THERE ARE several sources for program suppression wiring on the 605 control panel. These sources are: SUP NO TEST, SUP ON ±, SUP ON ZERO, SUP ON NON-ZERO. These must not be split wired together to the same PROGRAM SUPPRESSION ENTRY. SUPPRESSION FILTERS are provided which prevent this type of back circuit. Figure 93A shows an incorrect way of suppressing a program step from two sources that creates a back circuit whenever selector 15 and 16 are normal. The correct wiring for this same condition uses a suppression filter and is shown on Figure 93B.

WIRING BETWEEN CONTROL PANELS

IN GENERAL it is not advisable to control a feature of one CPC component from the control panel of another component except where hubs for this specific purpose have been provided. There are two reasons for this: (1) the 412-418, the 527 and the 605 all have separate power supplies which must not be interconnected through control panel wiring; (2) the operation of the various components is not synchronized and the timing relation between units may not permit the desired control to be accomplished.

As an example, consider the pilot selectors on the 412-418. In relation to 412-418 operation, these selectors are effectively held up through idle cycles. Actually the pilot selectors drop out during an idle cycle and are picked up again, but this drop-out occurs at a time when other 412-418 features (except the selection of a carry impulse) are not affected. But if it is attempted to control a 527 feature through a 412-418 pilot selector (e. g., to control the pickup of a 527 pilot selector during summary punching), this drop-out may prohibit the selection entirely.

There is, however, a permissible way of controlling 527 pilot selectors from the 412-418 control panel. The twelve summary punch control entry hubs on the 412-418 control panel (AW-BB, 63-64) are common with the 12-11 hubs of the correspondingly numbered twelve column splits on the 527 control panel (U, 1-12). By using these hubs for interconnection between the two control panels, a selector pickup impulse (such as an x impulse or CARD CYCLES) originating on the 527 control panel may be taken through a latch selector on the 412-418 control panel back to the pickup hub of a 527 pilot selector. Since the latch selector holds until its drop-out hub is impulsed, it will provide control during a summary punching operation.

Figure 94 shows the wiring for controlling 527 pilot selectors from the 412-418 accounting machine.

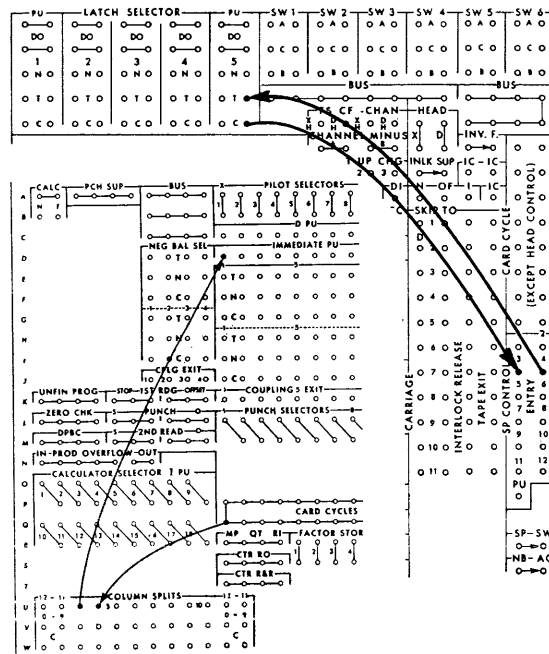

FIGURE 94. TYPE 527 PILOT SELECTOR PICKUP THROUGH 412 MACHINE CONTROL

DETERMINING MACHINE SPEED

Determining 605 Electronic Cycles

Occasionally it becomes necessary to determine the number of electronic cycles needed for an application. One sweep of the program unit constitutes 60 program steps. If PROGRAM REPEAT is active, the calculator will go through another sweep of 60 program steps. Thus calculate time can be extended indefinitely for a great many program steps through PROGRAM REPEAT and REPEAT DELAY programming.

These electronic cycles can be expressed in program steps or in milliseconds. Each program step consists of .74 milliseconds unless it is a multiply or divide program step. Multiply and divide operations vary in time depending on the number of positions of the MQ unit that are used and on the value of the digit in each position. During multiply or divide program steps the calculator operates with a shorter electronic cycle (.46 milliseconds) than normal crossfooting program steps. The following chart shows the time required to multiply or divide for various sizes of multiplier and quotient fields. The time is shown in equivalent program steps and in milliseconds. Either may be used to compute total calculate time required for a given application.

Maximum and average values are shown. The maximum values are computed by considering a 5 position multiplier as 99999. Average figures are approximately 68% of the maximum values.

		<i>Equivalent</i>			
		<i>Program Steps</i>		<i>Milliseconds</i>	
		<u>Max.</u>	<u>Average</u>	<u>Max.</u>	<u>Average</u>
Mply.	5 pos. mplier.	32	22	23.2	15.8
	4 " "	26	18	19.1	12.9
	3 " "	20	14	15.0	10.1
	2 " "	15	11	10.8	7.7
	1 " "	9	7	6.7	4.5
Divide	5 place Quo	36	25	26.0	17.7
	4 " "	30	20	21.4	14.5
	3 " "	24	16	17.7	12.0
	2 " "	19	13	13.6	9.3
	1 " "	13	8	9.4	6.4

Repeat Delay Period = 88 prog. steps or 65 milliseconds
 Unfinished Program Cycle = 540 prog. steps or 400 mil. secs.

Example: A program sweep during which 4 multiplications (using a 3 position multiplier in each case) and one division are programmed (developing a 3 place quotient) is completed as follows:

		<i>Average Equivalent</i>	
		<u>Program Steps</u>	<u>Average Milliseconds</u>
Multiply operations	14	14	10.1
	14	14	10.1
	14	14	10.1
Divide Operations	16	16	12.0
Remaining Program Steps	55	55	40.7 (55 x .74)
Total	113	113	83.0

The total calculate time required for this example is the equivalent of 113 crossfooting program steps or 83 milliseconds.

As another example, a 605 calculation consisting of one repeat delay period and two program sweeps where no multiply or divide operations are programmed requires the equivalent of 208 program steps or 153.8 milliseconds.

CPC Speed

The CPM speed of the CPC is determined by two factors:

1. Speed of the accounting machine (100 or 150 CPM)
2. Extended calculations beyond normal calculate time.

Most CPC applications are such that the normal calculate time is sufficient to perform all the required calculations. In these cases the CPC speed is predicted on the same basis as standard 402 operations.

Normal calculate time of the CPC consists of 80° (195° to 275°) of the 412-418 machine style. When the accounting machine is running at list speed (100

CPM) the 80° of calculate time allows more program steps in the 605 than when the 412-418 is running at high speed (150 CPM). For applications requiring lengthy calculations (primarily mathematical or scientific) the 412-418 operation is suspended and it waits until the calculator finishes the calculations. These 412-418 cycles are called UNFINISHED PROGRAM idle cycles. The 412-418 machine automatically restarts when it receives the calculate end signal. Figure 95 shows the resulting CPM speed of the CPC for variable number of electronic program steps. The chart is also calibrated in milliseconds so that either a millisecond or equivalent program step method of computing calculate time may be used.

The calculator application described under "Determining 605 Electronic Cycles" required the equivalent of 113 program steps or 83 milliseconds. By referring this to the chart (Figure 95) note that this application falls within the normal calculate time of the CPC. The 412 should be operated at 150 CPM for this application to produce maximum card speed on all cycles where printing is not required.

Applications which require 121 to 180 equivalent program steps should be setup to operate the machine at list speed (100 CPM). If the 412 were operating at 150 CPM, unfinished program idle cycles would occur and the resultant card speed would be 75 CPM. However, applications in the 180 to 660 electronic program cycle range are all accomplished at a rate of 75 CPM (non list operation) or 62½ CPM (list operation).

605-527 Speed

Independent use of the 605-527 units as a calculator provides a different program capacity than a 604-521 machine. Approximately 156 electronic program cycles (115 milliseconds) are available during normal calculate time. If punch delay is wired approximately 800 electronic program steps can be performed in the cycle that the punch is waiting for the 605 to finish calculating.

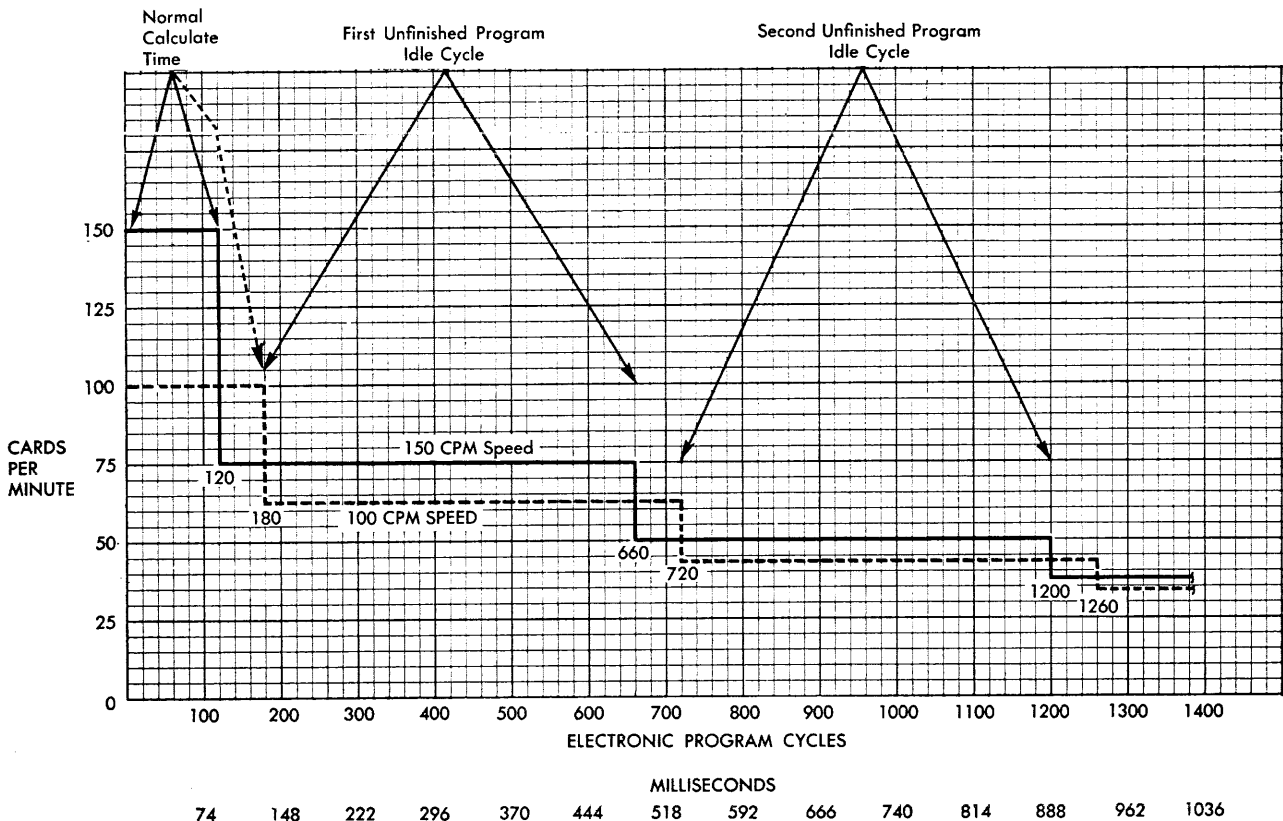

FIGURE 95. CHART FOR ESTIMATING CPC CARD VOLUME

CONTROL PANEL SUMMARIES

FUNCTIONS of the various hubs on the control panels are summarized in this section. The numbers refer to the circled numbers on the corresponding diagrams in Figures 96, 97, and 98.

412-418 CONTROL PANEL

1. *Pilot Selectors PU (Pickup)* (1-60: A-C, 1-42; F-H, 1-18, 61-76: AL-AN, 65-80). Seventy-six pilot selectors are standard. They are of two types. Both types are two-position selectors, each having a 12-11, digit, and I pickup. The 12-11 pickup accepts an 11 or 12 impulse to transfer the selector on the following cycle. The digit pickup of pilot selectors 1-60 accepts a 0-9 impulse only, and the digit pickup of pilot selectors 61-76 accepts a digit, 11 or 12 impulse to transfer the selector on the following cycle. The I (immediate) pickup accepts any impulse to transfer the selector immediately. The I hubs also serve as coupling exits. Each selector has two sets of common, normal, and transferred hubs. These hubs for pilot selectors 1-60 are located near the hubs of the correspondingly numbered co-selectors. For pilot selectors 61-76 they are directly under the pickup hubs.

2. *Co-selectors I PU's (Immediate Pickups)* (D-E, 1-42; I-J, 1-18; AJ-AK, 69-80). These hubs are entries to transfer co-selectors. The selector transfers immediately and remains transferred until the end of the cycle. Co-selectors may be coupled to pilot selectors by controlling them from the pilot selector coupling exit. Seventy-two co-selectors are standard.

3. *Comparing Entry* (F, 19-38; I, 19-38). The comparing entry hubs are wired from second and third reading in normal operations. The entry hubs may be used interchangeably, but their relationship must be the same, that is, if the first five hubs are used in one set of entries, the corresponding five hubs must be used in the other set of entries.

4. *Comparing Exit* (G-H, 19-38). Each set of entry hubs has a corresponding pair of common comparing exit hubs. They are diagonally arranged for convenience in jackplugging. Whenever a reading at one station does not agree with the reading at another station, the comparing hubs emit an impulse, which is normally wired to program start. The comparing exit may also be used to control other functions, such as hammerlock control or carriage skip, when wired to D pickup.

As the last card passes the last control station on either the 412 or 418 machine, an impulse will be available out of the lower left comparing exit hub (labeled LC). This hub may be wired to either minor, intermediate, or major program start to cause the corresponding program to be initiated on the run-out. When the last card comparing exit is used, normal program controls are not suspended.

5. *Coding Selectors* (J, 21-40; K-L, 1-40). There are ten ten-position coding selectors. They operate like digit selectors and are used to distinguish the various instruction codes which are punched in the program cards. They are

normally wired to the digit pickups of selectors, which cause the machine to perform the indicated operation. The coding selector common hubs are located at N-O, 41-45.

6. *Normal Zone Entry* (M, 1-43). The 43 normal zone entries are used to zone the type bars for normal cards. They are wired from second reading. These hubs are inactive on the 418.

7. *Second Reading* (N-O, 1-40). These hubs are exits from the 80 brushes that read the card at the second reading station. They are used in standard 412-418 operation for comparing with the third reading station and for zoning (412 only). They are also used for controlling features such as selectors, hammerlocks, or carriage skip. For CPC operation, channel A and B instructions, negative signs, etc., are read here.

8. *Third Reading* (P-Q, 1-40). These hubs are exits from the 80 brushes that read the card at the third station. They are normally wired to print entry, counter entry, factor and general storage, and comparing entry. For CPC use, channel C shift and operation instructions are read here.

9. *Co-selectors*. Each selector has five positions and may be used independently or may be coupled with a pilot selector. When the selector is picked up, there is an internal connection between C (common) and T (transferred). When the selector is not picked up, there is a connection between C and N (normal).

10. *Normal Alphamerical Print Entry* (U, 1-43). These hubs are print entries to the alphamerical type bars, and are normally wired from third reading, counter exits, channel hubs, or 605 exit hubs. The 44th hub is used on the 418 only.

11. *Numerical Print Entry* (V, 1-45). These hubs are print entries to the numerical type bars, and are normally wired from third reading, counter exits, channel hubs, or 605 exit hubs.

12. *Counter Exit* (Z-AC, 1-40). These hubs are normally exits from the counters for both detail printing and total printing. They may be wired to alphamerical or numerical print entry or to the exits of other counters, in which case the latter exits serve as entries. They may also be wired to entries of other counters, channel C entry, or 605 entry hubs.

13. *Counter Entry* (AG-AJ, 1-40). The number on each counter identifies its size and the letter its location. Counter entries are normally wired from third reading.

14. *Top Counter Read-Out* (AT-AW, 1-40). There are 80 pairs of hubs which correspond to the 80 counter positions in the 412-418. On all active machine cycles they emit digit impulses coinciding with the number standing in the counter at that time. Top counter read-out is used primarily to read out of the counter without resetting. If the counter contains a negative number, it will read-out in complement form. The lower hub of the high order position emits an impulse (similar to negative balance test exit) when the counter value is negative. It is used as a sign exit hub for that counter.

15. *Channel A* (BG-BI, 1-12). These hubs are 941 read out hubs. They are exits for numbers, with sign, which

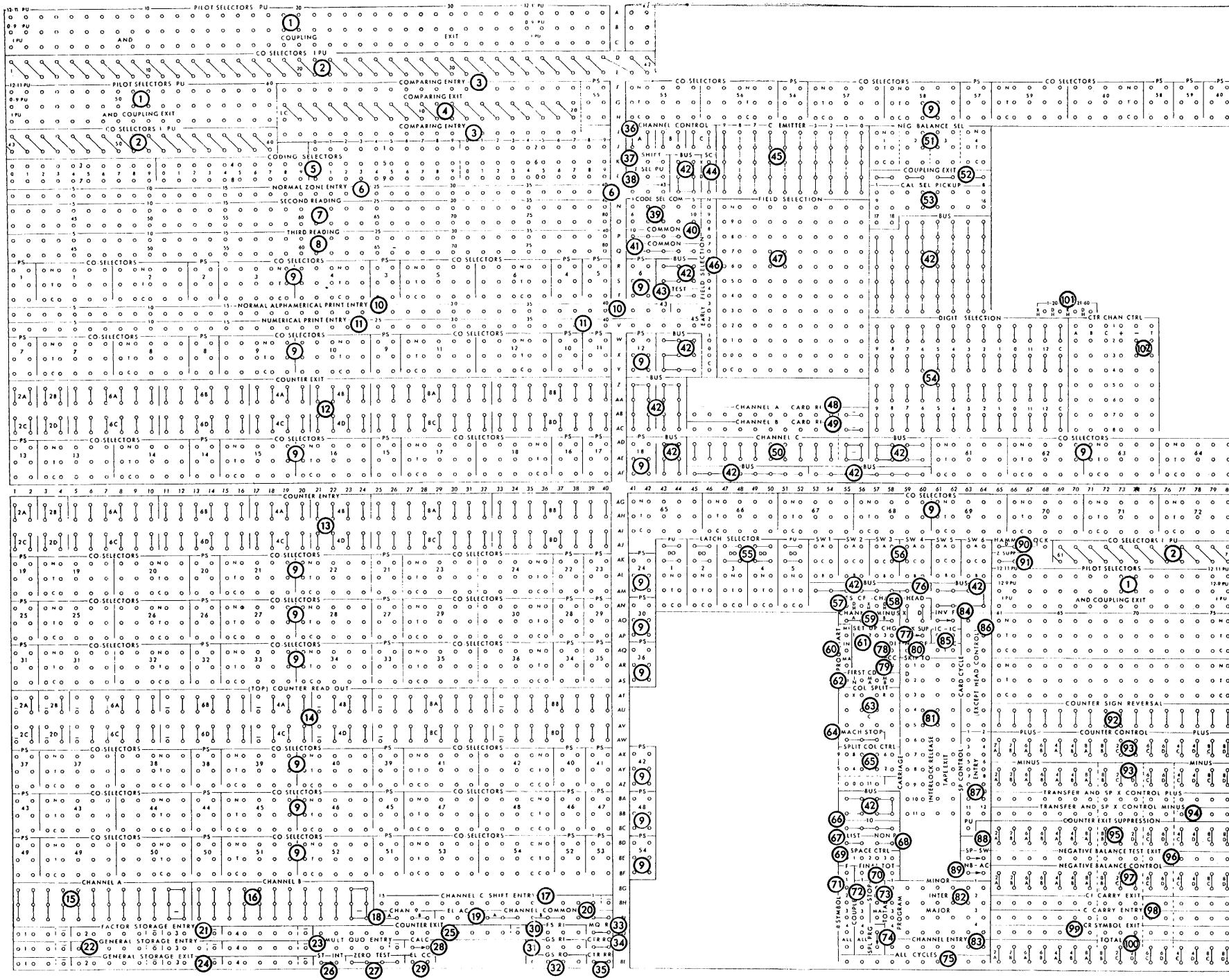

FIGURE 96. TYPE 412-418 CONTROL PANEL SUMMARY

are transmitted over channel A from the Type 941 storage unit. The extra hubs for each position are normally wired to Type 605 FS or GS entry but may also be wired to counter entry, comparing entry, or print entry.

16. *Channel B (BG-BI, 13-24)*. These hubs are 941 read out hubs. They are exits for numbers, with sign, which are transmitted over channel B from the Type 941 storage unit. The extra hubs for each position are normally wired to Type 605 FS or GS entry but may also be wired to counter entry, comparing entry, or print entry.

17. *Channel C Shift Entry (BH, 25-40)*. These 15 digit hubs and the sign hub are entries for numbers read into channel C from the 605. The shift unit will shift up to 6 positions to the right, under control of the shift code in the instruction card. Normal wiring is from counter exit, or general storage exit, to the ten left positions of channel C shift entry.

18. *Channel 9, A, B. (BI, 25-28)*. These hubs emit a 9 impulse whenever channel A or B is transmitting a negative number in complement form. They are wired to the high order (left) positions of the 412-418 counter groups which are not wired to channel A or B. They are also used to fill up the high order position of 605 storage units when reading in over channels A or B. The 9 impulses are necessary for correct conversion of complements.

19. *EL AC (Electronic All Cycles) (BI, 29-31)*. These hubs emit an impulse on every machine cycle except idle cycles. It is normally wired to 605 CTR RO or 605 CTR RR.

20. *Channel Common, A, B, C (BI, 32-40)*. These hubs emit impulses which are used to make the 605 units read in or out. A and B are for read in, C is for read out. They are used when numbers are being transferred via the usual channel operation. Any digit impulse wired to the tens position of channel control causes the corresponding channel common hub to emit.

21. *Factor Storage Entry (BJ, 1-20)*. These are entry hubs for numbers and signs into the 605. Factor storage entry hubs will accept an amount regardless of the FSR1 hub wiring. If FSR1 is not impulsed, the storage unit is not reset and the amount read-in is added to the previous amount without carry. Therefore fields wired to factor storage entry should be selected.

22. *General Storage Entry (BK, 1-20)*. These are entry hubs for numbers and signs into the 605, and are similar in function to factor storage entry hubs.

23. *Mult Quo (Multiplier-Quotient) Entry (BK, 21-26)*. These are entry hubs for digits into the multiplier-quotient unit of the 605. They function similar to factor storage entry hubs.

24. *General Storage Exit (BL, 1-20)*. These hubs are exits for numbers and signs from the general storage units of the 605. They are normally wired to channel C, print hubs, or counter entry (412-418).

25. *Counter Exit (BJ, 21-34)*. These are exit hubs from the electronic counter in the 605. They are normally wired to 412-418 counter entry, print hubs, channel C shift entry, channel C.

26. *St. Int (Storage Interlock) (BL, 21-22)*. When this switch is wired on, the CPC will not operate unless the power switch of the 941 storage unit is turned on. If more than one 941 is used, all must be turned on.

27. *Zero Test (BL, 23-26)*. These hubs are exits for impulses from the 605 when a zero test has been made and the 605 counter did not stand at zero on the program on which it was tested. These zero test hubs emit a "ten" impulse.

28. *Calculate (BK, 27-28)*. This switch must be wired on when the 605 is used with the 412 or 418 as part of the CPC.

29. *EL CC (Electronic Card Cycles) (BL, 27-28)*. These hubs emit impulses identical in timing with electronic all cycles impulses. They are available only on card cycles.

30. *FS RI (Factor Storage Read In) (BJ, 35-38)*. These hubs accept a 10 impulse to cause the factor storage unit to reset before read-in. These hubs do not control factor storage entry. When they are used, the corresponding hubs on the 527 control panel must not be wired.

31. *GS RI (General Storage Read In) (BK, 35-38)*. These hubs accept a 10 impulse to cause the general storage unit to reset. When they are used, the corresponding hubs on the 527 control panel must not be wired.

32. *GS RO (General Storage Read Out) (BL, 35-38)*. These hubs accept impulses to cause the general storage units to read out numbers. Read-in and read-out hubs must not be impulsed on the same cycle, as neither operation will be performed correctly. These hubs can only be connected to ELAC, ELCC, or Channel C common hubs. When they are used, the corresponding hubs must not be wired on the 527 control panel.

33. *MQ RI (Multiplier-Quotient Read In) (BJ, 39-40)*. These hubs accept impulses to cause the multiplier-quotient unit to reset. When they are used, the corresponding hubs must not be wired on the 527 control panel.

34. *CTR RO (Counter Read Out) (BK, 39-40)*. These hubs accept impulses to cause the electronic counter to read out. When these hubs are impulsed, the counter does not reset. They are usually impulsed from channel C common or electronic all cycles, never from the standard 412 or 418 all cycles.

35. *CTR RR (Counter Read Out and Reset) (BL, 39-40)*. These hubs accept impulses to cause the electronic counter to read out and reset. These hubs are usually wired from channel C common or electronic all cycles, never from the standard 412 or 418 all cycles.

36. *Channel Control A, B, C (I-J, 41-46)*. These hubs accept impulses from the channel A, B, and C code field of the instruction card to control the entry of numbers onto channels A, B, and C. Channel A and B controls are normally wired from second reading and channel C from third reading. A zero in the tens position of channel A or B fields makes channel card RI hubs active.

37. *Shift (K, 41-43)*. These hubs accept digit impulses (1 through 5) from the shift code in the instruction card to control the number of places of right shift of the result. They are normally wired from third reading. A shift of six can be obtained by multiple punching of 4-2 or 5-1 in the card.

38. *F SEL PU (Field Selector Pickup) (L, 41-43)*. These hubs accept digits 0 through 9 to cause the field selector to transfer for the following machine cycle. They also cause the early field selector to transfer immediately to pass 11 or 12 impulses on the same card cycle.

39. *CODE SEL COMM (Code Selector Common) (N-O, 41-45)*. These are the inlet hubs of the ten coding selec-

tors. These hubs are normally wired from the card columns which contain codes.

40. *10 Common (P, 41-45)*. These hubs emit a 10 impulse on all cycles except idle cycles, provided card feed channel hold is off. The hubs are used when it is desired to read into 605 storage without using channels A or B.

41. *9 Common (Q, 41-45)*. These hubs emit a 9 impulse on all active machine cycles provided cards are in the machine. The impulse is not affected by card feed channel hold.

42. *Bus*. These hubs are located at various places on the control panel. They are used to eliminate split wiring.

43. *Test (T, 43-45)*. These are special stop hubs which accept any digit impulse to stop the machine. However, if the impulse received is prior to calculate time the CPC will stop and will not calculate on that cycle. To circumvent this, wire the impulse to the immediate PU of a selector and a split column 11 impulse through the transferred side of the selector to the TEST hub.

44. *S C (Storage Clear) (K-M, 46)*. These hubs accept impulses to cause the banks of the 941 to reset on the following machine or card cycle. Only one bank can be cleared at a time. The X hub will accept only 11 and 12 impulses, the D hubs any impulse 9 through 12. The number of the storage bank to be cleared must be punched in the channel C instruction field (tens position).

45. *C Emitter (Continuous Emitter) (I-M, 47-56)*. There are five common hubs for each digit from 0 through 9. These hubs emit an impulse on every machine cycle except idle cycles. These are exit hubs only.

46. *Early Field Selection (N-Y, 46)*. This is an eleven level, one-position selector associated with the field selector. It transfers immediately with the pickup of the field selector and is used to accommodate the algebraic sign of numbers that are selected by the field selector.

47. *Field Selection (N-Y, 47-56)*. This is an eleven level, ten-position selector. Each position has a common, normal and ten transferred hubs labeled with digits 0 through 9. The pickup hubs for the field selector are located at (L, 41-43). When the field selector pickup receives any digit impulse from 0 through 9, the field selector transfers on the next active machine cycle to the level corresponding to the digit impulse.

48. *Channel A Card Read-In (AB, 45-56)*. These hubs are for reading factors from cards into channel A. They are normally wired from third reading hubs. Brush isolation relays isolate these hubs from the channel except when a zero is entered in the tens column of channel A control. The minus hubs are not the entry for the minus sign from the card into channel A (see 59 below). The minus hubs are used for controlled entry directly into the 605 or for controlled transfer from channel A to channel C.

49. *Channel B Card Read-In (AC, 45-56)*. These hubs are for reading factors from cards into channel B. They are normally wired from third reading hubs. Brush isolation relays isolate these hubs from the channel except when a zero is entered in the tens column of channel B control. The minus hubs are not the entry for the minus sign from the card into channel B (see 59 below). The minus hubs are used for controlled entry directly into the 605 or for controlled transfer from channel B to channel C.

50. *Channel C (AD-AE, 45-56)*. These hubs are entries for numbers, with sign, which are to be sent to Type 941 storage units. The double hubs are used to connect

other units to the channel C network, such as, Type 412 counter entry, print entry, Type 605 counter, GS exits, or comparing magnets.

51. *Neg Balance Sel (Negative Balance Selector) (I-K, 57-64)*. These selectors are used to control functions on the 412-418 control panel as a result of negative balance tests made on the 605. The pickup hubs of the negative balance selectors are located on the 605 control panel. When a pickup hub is impulsed, the corresponding selector will be transferred for the following 412-418 machine cycle.

52. *Coupling Exit (Neg Balance Sel) (L, 57-64)*. These hubs emit when a negative balance test is made on the 605 and a negative number is found in the 605 counter. They continue to emit until after the start of calculate time on the following 412-418 card cycle. The hubs may be used to pick up other selectors.

53. *Cal Sel Pickup (Calculate Selector Pickup) (M-N, 57-64; O, 57-58)*. These hubs are entries for impulses to cause transfer of the correspondingly numbered calculator selectors on the 605 control panel.

54. *Digit Selection (V-AC, 57-69)*. These selectors are used to select specific digits from a card column, or to emit constant digits. The C hub is impulsed from a reading station if a specific digit is to be selected, or from DI (digit impulse) if the selector is to be used as a digit emitter.

55. *Latch Selector (AJ-AN, 43-52)*. There are four latch selectors, each with pickup, drop-out, common, normal, and transferred hubs. They may be picked up by any impulse that is available on the 412-418 control panel, and remain transferred until the drop-out hub is impulsed. Both pickup and drop-out are immediate.

56. *SW 1-6 (Switches 1-6) (AJ-AL, 53-64)*. These panel switches are two-position selectors under the control of toggle switches directly above the control panel on the exterior of the machine. Two are standard; four more are optional. When a toggle switch is thrown to A (or B), any impulse wired to the C hub of the corresponding switch will be available at the A (or B) hub. When other selectors are picked up through one of these switches, the C hub should be wired from an impulse of short duration, such as a card count or 11-12 impulse.

57. *FSH (Field Selector Hold) (AN, 55-56)*. These hubs will accept impulses to cause the field selector positioning instructions to be held throughout any machine cycles which intervene before the next card cycle. The field selector will not transfer to its instructed level until that next card cycle. The X hub accepts only 11 and 12 impulses. The D hub accepts 9 through 12 impulses.

58. *CFCH (Card Feed Channel Hold) (AN, 57-58)*. These hubs will accept impulses to cause the channel instructions to be held throughout any machine cycles which intervene before the card cycle. The X hub accepts only 11 and 12 impulses; the D hub accepts 9 through 12 impulses. This hub is normally impulsed from the last card before a program cycle or comparing exit.

59. *Channel Minus, A, B (AO, 55-58)*. These hubs are entries for the sign (11 or 12 punch) associated with a negative number which is read from a card into channel A or B. They are normally wired from second reading.

60. *Prog Start MI, IN, MA (Program Start, Minor, Intermediate, Major) (AP-AR, 55)*. These hubs accept an impulse to cause a program change on the same cycle. They are wired from comparing exits to cause a program change

for every group, or from card count or digit impulse, to cause a program change for every card. The MI, IN, and MA hubs accept impulses to activate the minor, intermediate and major total program hubs.

61. *Set-up Chg (Change)* (AP, 56-58). These three hubs are associated with three toggle switches directly above the control panel on the exterior of the machine. When a toggle switch is on, the corresponding set-up change hub emits an impulse on each card cycle. This impulse may be used to pick up selectors, through which wiring changes can be controlled. Immediate pickup must be used.

62. *First Cd (Card)* (AS, 55-58). These hubs are normally wired to counter add, carriage skip to I, hammerlock I, the I pickups of selectors, and machine stop.

MI (Minor). This hub emits an impulse for the first card of every minor group, including groups with heading cards. If it is wired to a counter plus, the counter will add the first card of a minor group. If it is wired to a carriage skip to I, skipping will take place before the first card of the following group. If it is wired to hammerlock I, it suppresses minor first card printing for those type bars having the long hammerlock levers raised.

IN (Intermediate). This hub emits an impulse for the first card of every intermediate group. It is similar in function to first card minor.

MA (Major). This hub emits an impulse for the first card of every major group. It is similar in function to first card minor.

MB (Minor Body). This hub emits an impulse for the first card of every minor group in the body when head control is wired. It is normally wired to control group indicate counters during summary punching operations. When wired to hammerlock I, it may also be used to control hammerlocks.

63. *Column Split* (AT-AV, 55-58). Each column split has a C (common), 0-9, and 11-12 hub. Column splits are used to separate 11 and 12 punches from 0-9 punches in a card column.

64. *Machine Stop* (AW, 55-57). The three common hubs accept first card, total program, negative balance test exit, or selected card cycle impulses. When these hubs are impulsed, the machine stops and the stop light is turned on. It can be turned off only by depressing the final total key; the machine may be restarted by depressing the start key.

65. *Split Column Control* (AX-AZ, 55-58). These hubs emit impulses at half after the number. Hub 1 emits an impulse halfway between 1 and 0. Hub 0 emits an impulse halfway between 0 and 11. Hub 11 emits an impulse halfway between 11 and 12. They are normally wired to immediate pickups of selectors, which in turn may be used as column splits. The hubs labeled 9 through 2 function in the same way as the 1, 0 and 11 hubs; however, they are a special feature.

66. *10* (BC, 55-58). These hubs, which are commonly referred to as "hot ten" hubs, emit a 10 impulse on card cycles only. They are normally wired to print entry and must not be wired to electronic read-in functions.

67. *List* (BD, 55-56). These hubs accept card cycles, all cycles, and negative balance test exit impulses to cause the machine to detail print. When they are not impulsed, the machine will group-print. Digit or 11-12 impulses may

not be wired directly to list. Normally, the list hub is impulsed from all cycles to cause detail printing and spacing for all cards including the total. For selective printing, card cycles may be wired to list through a selector.

68. *Non P (Non Print)* (BD, 57-58). When these hubs are impulsed, all spacing and printing is suppressed and the machine operates at a speed of 150 cards per minute. They are normally wired from total program exits in cross-footing operations, or from first card minor for group indication elimination.

69. *Space Control* (BE, 55-58). These hubs are normally wired from card cycles, all cycles, or total program exits. When the hub S is impulsed, spacing is suppressed. When 1, 2, or 3 is impulsed, printing is single-spaced, double-spaced, or triple-spaced. Space control takes precedence over normal spacing (6 lines to the inch). Single, double, or triple spacing for final total printing may be obtained by wiring final total hubs to 1, 2, or 3 space hubs.

70. *Final Total* (BF, 56-58). These three independent hubs emit an impulse to read out and clear counters under the following conditions: (1) The machine must be idling; (2) The hopper must be empty; (3) The final total key and the start key must be depressed simultaneously. They are normally wired to counter total hubs.

71. **Symbol* (BF-BK, 55). These hubs emit a 10 impulse during program cycles and are normally wired to numerical type bars directly or through selectors to print asterisk, credit or minus symbols. The F hub emits a 10 impulse on the final program, the 1 hub on the minor program, 2 on the intermediate program, 3 on the major program, and ALL on all programs. The 4 hub can be used only when special program is wired. These hubs may also be wired to the digit pickup of pilot selectors to control all cycles impulses to channel entry when the special program feature is being used.

72. *Couple* (BG-BK, 56). These hubs are normally wired to the I pickup of selectors to expand the 412-418 program exits. Hub 1 emits an impulse for the minor program, 2 for the intermediate program, 3 for the major program and ALL for all programs. Hub 4 can be used only when special program is wired.

73. *Stop MI, IN, MA (Minor, Intermediate, Major)* (BG-BI, 57). These hubs are entries to stop programming when special program is used. MI, IN, or MA stop is wired from the last step used, depending upon the type of program start that initiated the special program.

74. *Spl Prg (Special Program)* (BJ-BK, 57). When this switch is connected, normal programming is inoperative. Each program channel may then be independently controlled by wiring all cycles to channel entry directly or through pilot selectors. This feature provides a means of obtaining extra program cycles following a program change. Programming is started by impulsing a program start and stopped by impulsing a program stop corresponding to the particular program start that initiated the special program. Special program is optional on the 412-418.

75. *All Cycles* (BL, 55-64). These hubs emit an impulse on every machine cycle.

76. *Head X, D* (AN-AO, 59-60). These are entry hubs used to distinguish heading cards from body cards. The X may be wired directly from the reading brushes. The impulse to the D hub may have to be selected. The X hub

accepts 11 or 12 impulses and the digit hub accepts any impulse from 9 through 12. When head X or D is wired:

- (1) all heading cards are printed;
- (2) programming is suspended during heading card printing;
- (3) skipping from heading to first body line is automatic;
- (4) skipping to the first body line of a form is automatic when heading cards are missing.

77. *Inlk Sup (Interlock Suppression)* (AP, 59-60). When these hubs are connected, interlocking will be suppressed for all skipping. They are used when every skip is $3\frac{2}{3}$ inches or less.

78. *DI (Digit Impulse)* (AQ, 58). This hub emits an impulse for every digit and for 11 and 12 on every machine cycle. It is normally wired to the C of a digit selector to change the digit selector to a digit emitter.

79. *CC (Card Count)* (AR, 58). This hub emits a 1 impulse every time a card passes the third reading station. This impulse is normally wired to a counter to count cards, or to program start to cause a program change for every card.

80. *NI OF I (Non Indicate Overflow Indicate)* (AQ, 59-61). OF emits an impulse whenever the 12 hole in the carriage tape is sensed. It is wired to I (indicate) if sheet identification is desired after an overflow, and to NI (non-indicate) if sheet identification is not desired after an overflow. When I is wired, the carriage skips to the first printing line of the next form. When NI is wired the carriage skips to the first body line of the next form.

81. *Carriage Skip to D-I, Interlock Release, Tape Exit* (AR-BB, 59-62). *Skip to D-I*. All digits and 11-12 impulses must be wired to D. *Skip to I* will not accept digits, 11's, 12's, or Z1. *Skip to I* is normally wired from first card or total program exits.

Tape Exit. As each hole in the tape is reached or passed, the corresponding tape exit on the control panel emits an impulse. Tape exits are wired to interlock release to suppress interlocking when distances of $3\frac{2}{3}$ inches or less are skipped. They should never be wired to any other function.

Interlock Release. These entry hubs are wired from tape exit to suppress interlocking. Interlocking should never be suppressed for distances greater than $3\frac{2}{3}$ inches.

82. *Total Program* (BG-BJ, 58-64). These hubs emit impulses whenever program start is impulsed. When minor, intermediate, or major program start is impulsed, minor, intermediate or major total program is active. Each program requires a separate cycle, unless coupled. Each total program has seven independent exit hubs which are normally wired to counter total to cause a counter to read out and clear. The nature of the total will depend on the type of program wired. They may also be wired: to carriage skip to I; to cause skipping before predetermined total printing; to hammerlock I to control hammerlocks; to counter control to add transferred totals from transmitting counters on non-net balance machines. Prog. 4 can be used only when special program is wired.

83. *Channel Entry* (BK, 58-64). Each vertical row of total hubs has a corresponding channel entry which must be wired from all cycles directly or through selectors when special program is wired. If all cycles is wired directly to any channel entry, the hubs immediately above it may be used to control functions on the 1st, 2nd, 3rd and 4th

steps. These hubs should not be confused with the channel A or B, or channel shift entry hubs. They are used only in connection with the programming of the 412-418.

84. *Inv F (Inverted Form)* (AO, 61-62). These hubs must be connected when inverted forms are used. Automatic skipping is effective between body and heading cards instead of heading and body cards.

85. *IC (Indicate Control)* (AP, 61-62; AQ, 62). These three independent hubs emit impulses on the sheet identification cycle following an overflow when OF is wired to I (indicate). One hub is wired to counter plus, one to counter minus, and the other to counter total, for two purposes: (1) To print sheet identification information from counters; (2) To prevent counter clearing (same as progressive total printing).

86. *Card Cycles* (AO-AV, 63-64). These hubs emit an impulse as a card passes the third reading station. They are normally wired to counter control plus or minus, to counter exit suppression, or through a selector to control zone suppression or hammerlocking. The top five hubs in the left column emit impulses for all card feed cycles including HC (heading cards). The remaining eleven hubs are not active for HC.

87. *SP (Summary Punch) Control Entry* (AW-BC, 63-64). These hubs are common to 11-12 hubs of corresponding column splits on the summary punch control panel. When an entry hub is impulsed from summary punch X control + or -, an X is available from the column split to identify the summary card. The pickup hub must be impulsed before summary punching will take place and is normally wired from one or more total program exits, to summary punch minor, intermediate and major totals for standard 412-418 operations. The impulse to the PU hub may be selected to eliminate summary punching for certain conditions, such as zero balances.

88. *SP SW (Summary Punch Switch)* (BE, 63-64). These hubs must be connected whenever summary punching is desired. They synchronize the operation of the accounting machine and the summary punch.

89. *NB AC (Negative Balance All Cycles)* (BF, 63-64). When the NB AC switch is wired, each negative balance test exit emits on every active machine cycle on which the corresponding counter contains a negative number. When this switch is on, negative balances in counters can be detected on card cycles as well as program cycles.

90. *Hammerlock* (AJ, 65-68). The D (delay) hub will accept digit, 11, 12, and comparing exit impulses to control hammerlocking on the following cycle. The I (immediate) hub will accept first card, total program, negative balance test exit, and selected card cycles impulses to control hammerlocking on the same cycle. When either hub is impulsed and the long hammerlock levers are raised, printing from those typebars is suppressed.

91. *Z Supp (Zone Suppress)* (AK, 65-66). These common hubs will accept an 11, 12, or selected card cycles to suppress all zoning for any designated card. The 11 or 12 punch may be wired directly to zone suppress from the station preceding the printing of the card. If a card cycle is wired to zone suppress, it must first be controlled through a selector.

92. *Counter Sign Reversal* (AU-AV, 65-80). There is a pair of common hubs for every counter in the 412-418. When a counter sign reversal hub is impulsed, the operation

of counter control plus and minus is reversed for that counter.

93. *Counter Control Plus, Minus (AW-AZ, 65-80)*. Each counter has two common plus entry hubs. When they are impuled from card cycles, first card, total program or transfer control, the counter adds. Each counter has two common minus entry hubs. When they are impuled from card cycles, first card, total program, or transfer control, the counter subtracts.

94. *Transfer and SP (Summary Punch) X Control Plus, Minus (BA-BB, 65-80)*. These hubs are exits only on net balance machines. There is one plus and one minus hub for each counter. They emit an impulse whenever the counter total hub is impuled. The plus hubs emit when the counter is positive; the minus hubs emit when the counter is negative. They are used for two purposes: (1) To add or subtract in receiving counters totals transferred from other counters; (2) To impulse SP control entry so that an 11 may be summary punched in the summary card for either plus or minus results.

95. *Counter Exit Suppression (BC-BD, 65-80)*. When a counter exit suppression hub of a given counter is impuled, exits from that counter are suppressed. They are normally wired from card cycles to suppress detail printing from the counter; from first card minor, intermediate or major to suppress printing from first cards of corresponding groups; from total programs to suppress total printing; and from negative balance test exit to suppress printing of negative balances.

96. *Negative Balance Test Exit (BE, 65-80)*. Each counter has a negative balance test exit hub which emits an impulse when the counter total hub is impuled and the counter is negative. When negative balance all cycles is connected, they emit impulses as described under 89. They are normally wired to counter exit suppression, to a pilot selector digit pickup, to negative balance control, or to list.

97. *Negative Balance Control (BF-BG, 65-80)*. Each counter has a pair of hubs which receive negative balance test exit impulses to convert complement balances to true figures.

98. *CI Carry Exit, C Carry Entry (BH-BI, 65-80)*. Whenever a counter is wired for subtraction, the corresponding counter CI-C must be connected. Whenever a counter is to be coupled with another counter, the CI of the counter containing the units position must be wired to the C of the coupled counter, and the CI of the coupled counter to C of the counter containing the units position. When a zero balance (which is the result of compensating + and - entries) stands in the counter, an 11 impulse can be wired through C and CI to pick up a selector.

99. *CR (Credit) Symbol Exit (BJ, 65-80)*. These hubs are used for detail printing and total printing on a net balance operation, but only for detail printing on a non-net balance operation. When the credit symbol exit of a counter is wired to an even-numbered numerical typebar, a credit symbol (or minus sign) is printed when the number in the counter is negative.

100. *Total (BK-BL, 65-80)*. Each counter has two common total hubs. They are entry hubs which are normally wired from total program to cause the counter to read out and reset. They may also be wired from first card minor, intermediate or major from selected card cycles, or from IC (indicate control).

101. *Pilot Selector Hold, XH, DH, 1-20 and XH, DH, 21-60 (U, 68-71)*. An 11 or 12 into the XH hub, or a digit impulse into DH hub causes the CPC pilot selectors (1-60) to operate like conventional 402 pilot selectors. The 1-20 hubs apply to pilot selectors 1-20. The 21-60 hubs control pilot selectors 21-60 as a group. The pilot selector hold feature does not affect the individual pilot selector pickup. It does cause pilot selectors that are picked up to remain transferred until the next card cycle even if program cycles intervene.

102. *CTR CHAN CTRL (Counter Channel Control) (V-AC, 70-75)*. These are exit hubs. Instruction code impulses into channel control A, B, C hubs determine which of the counter channel hubs emit. Digit impulses 1-8 into the units position of channel control determine the horizontal row of CTR CHAN CTRL which emits. Digit 1 causes row 1 to emit, etc. A digit 7 or 8 impulse into the tens position of channel control cause combinations of the +, -, and T hubs to emit. CTR CHAN CTRL A, B, C hubs are controlled to emit by their respective channel control hubs. These hubs are normally used to control 412 counter groups from coded instructions punched in cards.

605 CONTROL PANEL

1. *Program Source (A-D, 1-2)*. These hubs provide the only source of impulse for program pickup.

2. *PRG PU (Program Pickup) A(E-X, 1-2); B(Y-AR, 1-2); C(AS-BL, 1-2)*. Three series of pickup hubs (A, B and C) correspond to A, B and C program exits. When impuled (normally through selectors) from program source hubs, the associated program exits are activated in groups of three.

3. *Program Source Filters (A-J, 3-5)*. There are ten filters each with one IN and two OUT hubs. When a program source impulse is wired to the IN hub of a filter, the impulse is available at the two OUT hubs simultaneously. Program source filters are normally used to eliminate back circuits when selecting program pickups. (Consult special wiring section).

4. *Bus (A-D, 6-14; A-C, 15-16; A-D, 17-24; AZ-BL, 21, 22)*. These hubs are used to eliminate split wiring on the control panel.

5. *Calculator Selector Coupling Exit (I-J, 6-14)*. There are 18 coupling exits, each associated with a calculator selector. Each coupling exit emits an impulse whenever its calculator selector is transferred.

6. *Calculator Selectors (K-AK, 3-12)*. There are 18 calculator selectors standard on the machine. They are provided with pickup hubs on the 527 control panel for standard 521-604 operation and with pickup hubs on the 412-418 control panel for CPC operation. When a selector is picked up on one panel, the pickup hub on the other panel may not be used. When a calculator selector is picked up from 527 first reading (or 412-418 third reading, for CPC operation) it will remain up through 605 calculate time and may be used to select program source or other impulses on the 605 control panel.

7. *Suppression Filters (AL-AN, 3-12)*. There are ten suppression filters each with one OUT and two IN hubs. They are normally used to eliminate back circuits when it is desired to suppress the same program level with either one of

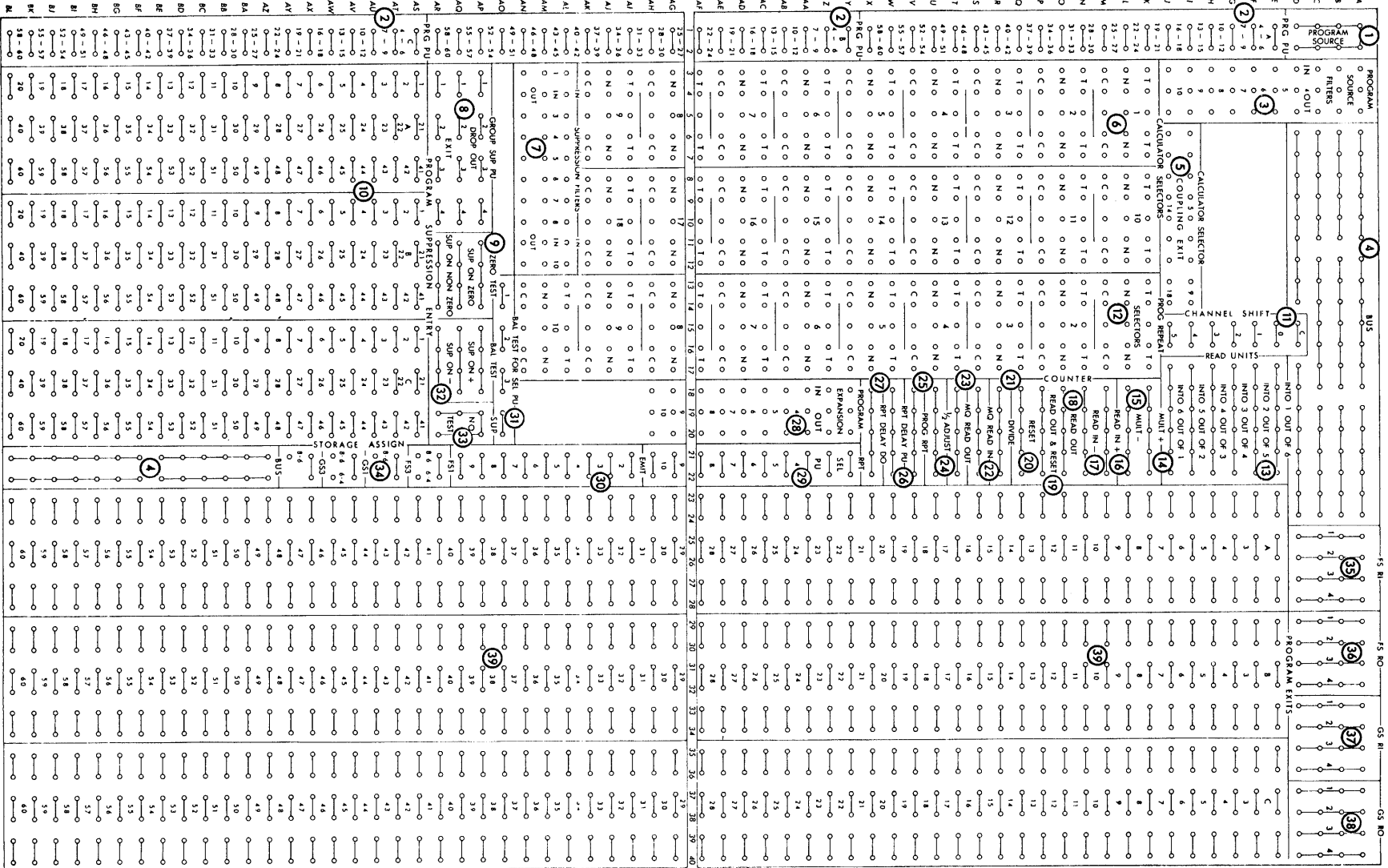

FIGURE 97. TYPE 605 CONTROL PANEL SUMMARY

two suppression impulses. They are used only in electronic circuits.

8. *Group Suppression (AP-AR, 3-10)*. Four group suppression units each with two common PU (pickup) hubs, two common DO (drop out) hubs, and two common exit hubs are standard on the machine. On the next program step after a group suppression unit is picked up, a program suppress impulse becomes available at the exit hubs of the unit and continues until the drop out hub is impulsed or another card feeds.

9. *Zero Test (AP-AR, 11-14)*. There are four zero test hubs which accept program impulses to test the counter for zero balance. If the balance is zero the suppress-on-zero hubs (AQ, 11-14) will emit and may be used to suppress succeeding program steps. If the balance is not zero, the suppress-on-non-zero hubs (AP, 11-14) will emit and may be used to suppress succeeding steps. The suppression hubs will continue to emit until another zero test is made or the next card feeds.

10. *Program Suppression Entry A (AS-BL, 3-8); B (AS-BL, 9-14); C (AS-BL, 15-20)*. These three sets of 60 hubs correspond to program exits A, B, C, and will accept any impulse which will suppress the associated program step.

11. *Channel Shift (D-J, 15-16)*. The channel shift unit is a six-way selector consisting of one pair of common hubs and six pairs of transferred hubs, 0-5, corresponding to the shift code on the card. Channel shift is used when the shift of the result in the 605 is to be determined by the shift code on the program card. It is picked up by the shift hub on the 412-418 panel.

12. *Program Repeat Selectors (K-AN, 13-17)*. There are ten 5-position selectors which are transferred at the end of a program sweep by impulsing the corresponding repeat pickup hub (Y-AH, 21-22). Program repeat selectors are normally used to select the program pickup source and thus determine which program exits will be picked up during the program repeat. A program repeat hub (V, 18-22) and repeat delay pickup (W, 18-22) must also be impulsed to give the selector points time to transfer.

13. *Read Units Into, Out of (E-J, 17-22)*. The read-units-into and read-units-out-of hubs have been combined on the 605. By means of these hubs, shifting from one to five positions may be done on any program level, and the shift unit will return to normal at the completion of the step.

Read-units-into applies to any receiving storage unit or the counter. The units position of a factor in storage may be read into the 2nd, 3rd, 4th, 5th, or 6th position of another storage unit or the counter during calculation by wiring from a program exit to the read-units-into hub. Read-units-out-of applies only to the counter. A number may be read out of the counter starting with the 2nd, 3rd, 4th, 5th, or 6th position by impulsing the read-units-out-of hub from a program exit. The number will enter the receiving storage unit starting with the units position. Read-units-out-of is normally used for dropping decimal places when transferring from the counter to storage.

14. *Mult + (Multiply plus) (K, 18-22)*. These hubs accept program impulses to cause the machine to multiply positively.

15. *Mult - (Multiply minus) (L, 18-22)*. These hubs accept program impulses to cause the machine to multiply negatively.

16. *Counter Read In + (M, 18-22)*. The counter is impulsed to add during calculation by wiring a program exit to counter read in plus.

17. *Counter Read In - (N, 18-22)*. The counter is impulsed to subtract during calculation by wiring program exit to counter read in minus.

18. *Counter Read Out (O, 18-22)*. The counter is impulsed to read out without clearing by wiring a program exit to these hubs.

19. *Counter Read Out and Reset (P, 18-22)*. The counter is impulsed to read out and clear by wiring a program exit to these hubs.

20. *Counter Reset (Q, 18-22)*. These hubs are entries for resetting the electronic counter without reading out. When these hubs are impulsed from a program exit, the counter resets at the beginning of the following program step. When counter reset and divide are wired on the same program step the reset will not occur until after division is completed.

21. *Divide (R, 18-22)*. These hubs accept program impulses to cause the machine to divide.

22. *MQ Read In (Multiplier-Quotient Read In) (S, 18-22)*. A factor may be read into the MQ unit during calculation by impulsing these hubs from a program exit.

23. *MQ Read Out (Multiplier-Quotient Read Out) (T, 18-22)*. Factors may be read out of the MQ unit during calculation by impulsing these hubs from a program exit.

24. $\frac{1}{2}$ *Adjust (U, 18-22)*. When the $\frac{1}{2}$ adjust hubs are impulsed from a program step, a 5 is added or subtracted in the units position of the counter, according as the number is plus or minus. This 5 may be shifted up to five positions by impulsing a read units hub.

25. *Program Repeat (V, 18-22)*. These hubs are impulsed from one of the program exits when it is desired to have the machine go through another sweep of 60 program levels.

26. *Rpt Delay PU (Repeat Delay Pickup) (W, 18-22)*. When any one of these hubs is impulsed from a program exit, the machine will pause before beginning a program repeat to give the program repeat selectors time to transfer. Repeat delay pickup is only impulsed when the program repeat selectors are used with program repeat.

27. *Rpt Delay DO (Repeat Delay Drop Out) (X, 18-22)*. When any one of these hubs is impulsed from a program exit, repeat delay is dropped out.

28. *Program Expansion (Y-AH, 18-20)*. There are ten sets of program expansion hubs each consisting of two OUT hubs and one IN hub. The hubs are used to increase the number of program exits in cases where split wiring would cause back circuits.

29. *Rep Sel PU (Repeat Selector Pickup) (Y-AH, 21-22)*. These are the pickup hubs for the program repeat selectors. When a pickup hub is impulsed from a program exit, the corresponding selector will transfer at the end of the program sweep, provided both repeat and repeat delay are also impulsed.

30. *Emit (AI-AQ, 21-22)*. The emitter can be used to enter a single digit into the counter, any storage unit or the MQ unit on a program step. Multiple digits can be entered into the counter only, one at a time, on as many program steps as there are digits. Digits are emitted and read into a unit by wiring a program step to a specific digit hub in the emitter and by impulsing the counter or storage unit

to read in. The digit normally goes to the units position but may be shifted up to 5 positions.

31. *Bal Test for Sel PU (Balance Test for Selector Pickup)* (AO, 13-20). These are the pickup hubs for the negative balance selectors located on the punch control panel and on the 412-418 control panel. When a pickup hub is impulsed from a program exit, the corresponding negative balance selector will pick up on the following 412-418 cycle if the 605 counter is negative on that program step.

32. *Bal Test (Balance Test)* (AP-AR, 15-18). On the next program step after the balance test hubs (AP, 15-18) receive an impulse from a program exit, a program suppression impulse becomes available either from the suppress on plus hubs (AQ, 15-18) if the 605 counter was positive on the step when it was balance tested or from the suppress on minus hubs (AR, 15-18) if the 605 counter was negative. The program suppression impulse continues until balance test receives another impulse from a program exit or until the next active 412-418 machine cycle.

33. *SUP NO TEST (Suppress without Test)* (AP-AR, 19-20). These hubs emit on every program step and are normally wired through calculator selectors to suppress certain program steps for specific cards.

34. *Storage Assignment* (AR-AY, 21-22). Factor storage 1 and general storage 1 may be assigned either to the 6th, 7th and 8th positions of the channels (or to the 4th, 5th, and 6th positions) by jackplugging the 8-6 hub (or the 6-4) to the common hubs above. Factor storage 3 and general storage 3 may be assigned to the 6th, 7th and 8th positions by jackplugging the 8-6 hub to the common hub. On the 604 these hubs are located on the 521 control panel.

35. *FSRI (Factor Storage Read In)* (A-D, 25-28). Information may be read into factor storage units during calculation by wiring a program exit to factor storage read in. These units clear automatically on a read in.

36. *FSRO (Factor Storage Read Out)* (A-D, 29-32). Information may be read out of a factor storage unit during calculation by wiring a program exit to factor storage read out.

37. *GSRI (General Storage Read In)* (A-D, 33-36). Information may be read into general storage units during calculation by wiring a program exit to general storage read in. These units clear automatically on the read in.

38. *GSRO (General Storage Read Out)* (A-D, 37-40). Information may be read out of a general storage unit during calculation by wiring a program exit to general storage read out.

39. *Program Exits A* (E-BL, 23-28); *B* (E-BL, 29-34); *C* (E-BL, 35-40). In the 605 there are three chains of program exits (A, B, and C) each having 60 sets of hubs corresponding to the 60 program levels. Three independent exits are available on a program level. The double program exit hub permits connecting program exits of different levels to develop a function chain. Program exit impulses are available on their respective program cycles when program source is wired to program pickup. A program exit must not be wired to more than one function. The only possible exception to this rule is the case of storage units which are assigned to operate together where the read-in or read-out hub of one unit is coupled to the similar hub for the other unit. Coupling any other two hubs together will cause machine failure. The paired circuit will reduce the operating voltage so that neither of the functions will

be performed correctly, and a back circuit will be set up through the split wires affecting some other program steps.

527 CONTROL PANEL SUMMARY

1. *Factor Storage Entry* (A, 25-44). These hubs are entries to the 605 factor storage units for factors read from a 527 card reading station or digit selector. They are normally wired from first reading, second reading or from the digit selectors. The hubs are not used for normal CPC operation, and they must not be used when the corresponding hubs are wired on the 412-418 panel.

2. *Mult Quot Entry (Multiplier-Quotient Entry)* (F, 39-44). These hubs are entries to the 605 multiplier-quotient unit for factors read from a 527 card reading station or digit selector. They are not used for normal CPC operation, and they must not be used when the corresponding hubs are wired on the 412-418 panel.

3. *First Reading* (G-J, 25-44). These hubs are not used in normal CPC operation. They are exits from the 80 columns of the card at the first reading station. Punches here can be used to control punch selectors, but not to read numbers into 412-418 counters.

4. *General Storage Entry* (K, 25-44). These hubs are entries into general storage units 1, 2, 3 and 4. They are not used for normal CPC operation, and must not be used when the corresponding hubs are wired on the 412-418 panel.

5. *Punch Selectors* (N-P, 25-44; X-Z, 25-44). When impulsed, these selectors transfer immediately and remain transferred until the end of the punch cycle. They are not normally used in CPC operation. They may be wired to first reading hubs to control punching from prepunched cards.

6. *General Storage Exits* (Q, 25-44). These hubs are exits from the 605 general storage units. They are normally wired to the 527 punching hubs, either directly or through punch selectors.

7. *Counter Exit* (S, 31-44). These hubs are exits from the electronic counter. They are normally wired to punching hubs, either directly or through punch selectors.

8. *Punching* (T-W, 25-44). The punching hubs are entries for punching results in any assigned columns of the card. They are normally wired from 605 counter exits, general storage exits, or the 412-418 counter exits. They may be wired from second reading for gang punching.

9. *Second Reading* (AA-DD, 25-44). These hubs are exits from the 80 columns of the card at the 527 second reading station. They are normally used for gang punching or for double punch and blank column detection.

10. *Double Punch and Blank Column Entry* (EE, 25-44). Ten double punch and blank column entry hubs are standard. They are entries for checking the presence of blank columns or double punching and are normally wired from 527 second reading.

11. *Double Punch and Blank Column Exit* (FF, 25-44). Ten double punch and blank column exit hubs are standard. They are exits from the double punch and blank column entry hubs and are normally wired to the punching hubs when gang punch checking. In the event of a double punch, only the lowest digit punched will be available (e. g., if 9 and 6 were punched, only the 6 would be available.)

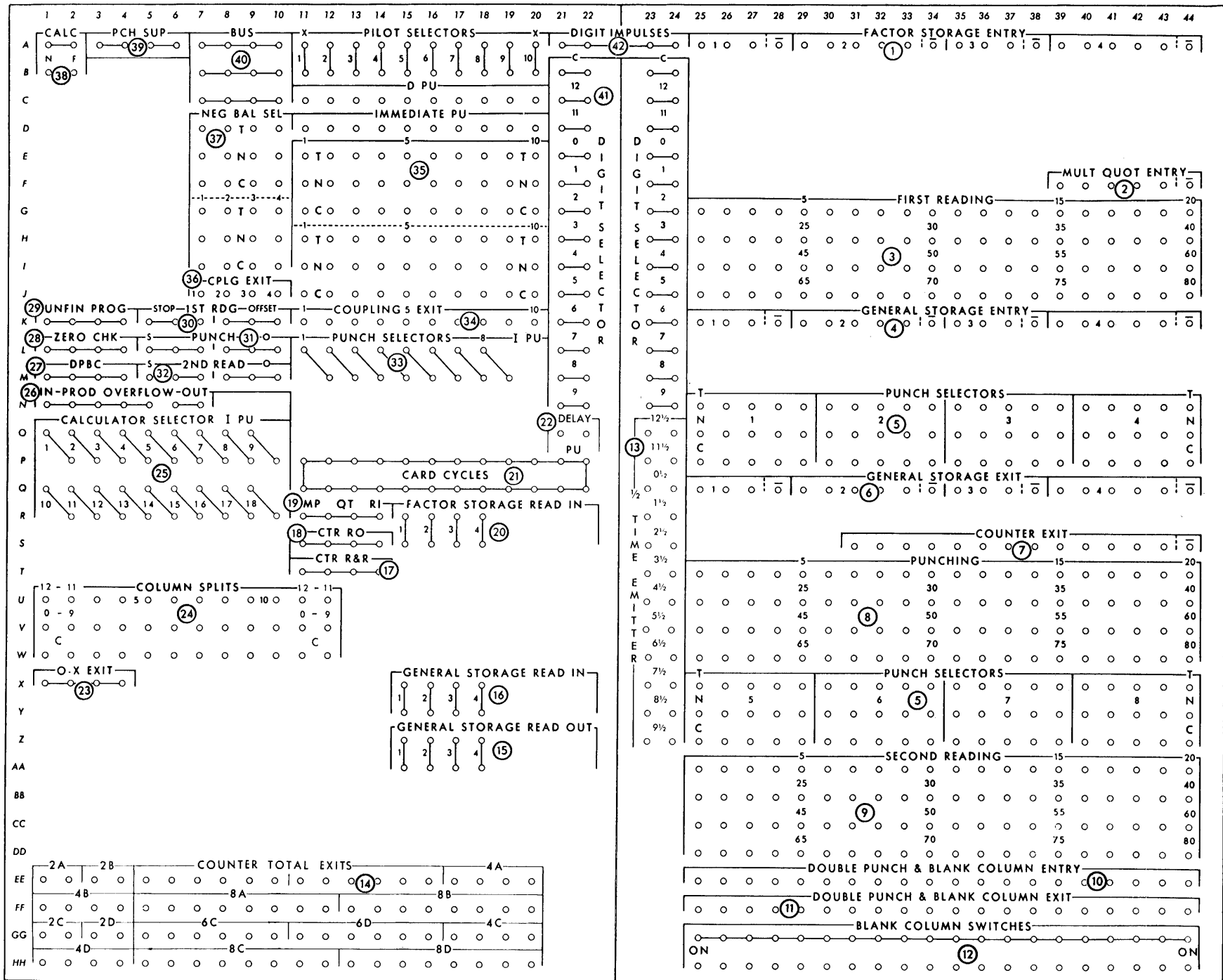

FIGURE 98. TYPE 527 CONTROL PANEL SUMMARY

12. *Blank Column Switches* (GG-HH, 25-44). These switches function only when the corresponding double punch hub is wired. When they are wired, blank columns are checked.

13. $\frac{1}{2}$ *Time Emitter* (O-Z, 23-24). These hubs emit impulses halfway between digit impulses. They are primarily used to make pilot and punch selectors perform as column splits between any two digits.

14. *Counter Exits* (EE-HH, 1-20). These hubs are exits for the 412-418 counters. They are normally wired to the punching hubs directly or through the column split (usual summary punching operation for negative signs). They may be selected.

15. *General Storage Read-Out* (Z-AA, 15-18). These hubs accept impulses to read factors out of the general storage units for punching. They are normally wired from 527 card cycles. They may be used either for CPC operation or for operation of the 605 as a calculating punch.

16. *General Storage Read-In* (X-Y, 15-18). These hubs accept only 11 impulses to read factors into the general storage units at 527 read time. They are normally wired from 527 card cycles. These hubs must not be wired when the corresponding hubs are wired on the 412-418 control panel. They are not normally used for CPC operation.

17. *CTR R and R* (*Counter Read-Out and Reset*) (T, 11-14). The counter read-out and reset hubs are entries for 527 card cycle impulses for reading out and resetting the counter at punching time. They may be used either for CPC operation or for operation of the 605 as a calculating punch.

18. *CTR RO* (*Counter Read-Out*) (S, 11-14). The counter read-out hubs are entries for 527 card cycle impulses for reading out the counter at punching time without resetting. They may be used either for CPC operation or for operation of the 605 as a calculating punch.

19. *MP QT RI* (*Multiplier-Quotient Read-In*) (R, 11-14). The multiplier-quotient read-in hubs accept only 11 impulses to cause a factor to enter the MQ unit from 527 card reading or digit selectors. They may be wired from 527 card cycles or from a 527 reading brush. These hubs must not be wired when the corresponding hubs are wired on the 412-418 control panel. They are not normally used for CPC operation.

20. *Factor Storage Read-In* (R-S, 15-18). These hubs accept only 11 impulses to read factors into the factor storage units at 527 read time. They are normally wired from 527 card cycles. These hubs must not be wired when the corresponding hubs are wired on the 412-418 control panel. They are not normally used for CPC operation.

21. *Card Cycles* (P-Q, 11-22). The 24 common card cycles hubs emit an impulse from 11 through 9 on each 527 card reading cycle. Since card movement is synchronized, a card cycles impulse may be used to control functions at the first reading, punching, and second reading stations simultaneously.

22. *Delay PU* (*Delay Pickup*) (O, 21-22). The delay pickup hubs are used when the 605 and 527 are used together as a calculating punch. They will accept card cycles, 11, or 12 impulses. The purpose of the hubs is to hold up the 527 when the 605 is going through a program repeat operation or any long calculation. However, wiring to the delay pickup when only normal calculating time is

required may slow up the machine. The hubs are not normally used for CPC operation.

23. *O-X Exit* (X, 1-4). These hubs emit 0 and 11 impulses on every 527 cycle. The 0 and 11 may be separated by means of a column split.

24. *Column Splits* (U-W, 1-12). These hubs are normally used for splitting a card column between 0 and 11. They may also be used for punching an 11 from the 412-418 (SPX control) when summary punching negative numbers. The SPX impulses from the 412-418 counters when wired on the 412-418 panel to SP control hubs are available at the 12-11 hubs, and can be used to pick up punch selectors or pilot selectors on the 527.

25. *Calculator Selector I PU* (*Immediate Pickup*) (O-R, 1-10). These hubs are the immediate pickups for the 18 calculator selectors. For CPC operation, the calculator selectors are not normally picked up on the 527 control panel; the corresponding hubs on the 412-418 control panel are used.

26. *Prod OF* (*Product Overflow*) (N, 1-7). The product overflow IN hubs are normally wired from one or more counter or general storage exit hubs that are in excess of the number of hubs wired to punch the result. If any digit other than zero is sensed, product overflow OUT will emit an 11 impulse which may be used to stop the machine or offset the card in the stacker.

27. *DPBC* (*Double Punch Blank Column*) (M, 1-4). These double punch blank column hubs emit an 11 impulse when the DPBC unit (10, 11, 12) is properly wired and a double punch or blank column is sensed. They are normally wired to second read stop. The hubs are not normally used in CPC operation.

28. *Zero Check* (L, 1-4). The zero check hubs emit an 11 impulse when the 605 counter does not balance to zero on a zero test. They are normally wired to first reading stop. The hubs are not active during CPC operation. They are active during operation of the 527 and 605 machine combination as an independent calculator.

29. *Unfin Prog* (*Unfinished Program*) (K, 1-4). When the 527 and 605 are used together as a calculating punch, it may happen that a calculation is not completed in time to punch the card, in which case no punching will take place and an 11 impulse will be emitted from the unfinished program hubs. This impulse is normally wired to first read stop. The hubs are not normally used in CPC operation.

30. *1st Rdg Stop-Offset* (*First Reading Stop Offset*) (K, 5-10). The hubs labeled S (stop) are entry hubs that accept an impulse to stop the machine for an error condition that is recognized at the 527 first reading station. The machine stops after the card in error reaches the stacker. The offset hubs are optional. When these hubs are impulsed, the error card is offset in the stacker. The hubs are not normally used for CPC operation.

31. *Punch Stop-Offset* (L, 5-10). The hubs labeled S (stop) are entry hubs that accept impulses to stop the machine for an error condition that is recognized at the punch station. The machine stops after the card in error reaches the stacker. The offset hubs are optional. When these hubs are impulsed, the error card is offset in the stacker. The hubs are not normally used in CPC operation.

32. *2nd Read Stop-Offset* (M, 5-10). The hubs labeled S (stop) are entry hubs that accept impulses to stop the

machine for an error condition that is recognized at 527 second reading. The machine stops after the card in error reaches the stacker. The offset hubs are optional. When these hubs are impulsed, the error card is offset in the stacker. They are not normally used in CPC operation.

33. *Punch Selectors I Pickup* (L-M, 11-19). These are the pickup hubs for the punch selectors. When impulsed, they transfer the selector immediately. They may be wired from 527 first or second reading or the coupling exit of a 527 pilot selector.

34. *Coupling Exit (Pilot Selectors)* (K, 11-20). The coupling exit hubs emit an impulse when the corresponding pilot selector is transferred and are normally used to pick up punch selectors.

35. *Pilot Selectors* (A-J, 11-20). There are five two-position pilot selectors, each having an X, D and immediate pickup hub. When the X or D pickup hubs are impulsed, the selector transfers on the following 527 card cycle and returns to normal at the end of that cycle. When the I pickup hub is impulsed, the selector transfers immediately and returns to normal at the end of the same cycle.

36. *Cplg Exit (Coupling Exit, Negative Balance Selector)* (J, 7-10). The coupling exit hubs emit an impulse when the corresponding negative balance selector is transferred and are normally used to pick up punch or calculator selectors.

37. *Neg Bal Sel (Negative Balance Selector)* (D-I, 7-10). The pickup hubs of the negative balance selector are located on the 605 control panel and are always wired from a program exit. When the pickup hubs are impulsed, the

selector transfers just prior to punching time and may be used to control functions on the punch control panel from certain conditions arising during calculation. The selector is not transferred during summary punch cycles of CPC operation. It is active for 527-605 calculator combination operations.

38. *Calc (Calculate)* (A-B, 1-2). This switch must be wired on when the 605 and 527 are used together, either as a calculating punch or as part of the CPC. The switch must be wired off when the 527 is used independently or used as a summary punch in conjunction with the 412-418 only.

39. *Pcb Sup (Punch Suppress)* (A, 3-6). The punch suppress hubs may be energized with any impulse available on the 527 control panel between 12 and 9 time. When impulsed from first reading, these hubs cause punching to be suppressed on the following card cycle, when the card will be at the punching station.

40. *Bus* (A-C, 7-10). These hubs are used to eliminate split wiring on the control panel.

41. *Digit Selector* (A-N, 21-24). Two digit selectors are standard. When the common (C) hubs are wired from 527 first or second reading, impulses from the digit hubs will be available as the corresponding digits are read from the card.

42. *Digit Impulses* (A, 21-24). These exit hubs emit an impulse for every digit on every machine cycle, including Run-In and Run-Out cycles. It is normally wired to the C of a digit selector to make it a digit emitter.

TIMING CHARTS

CPC MODEL A1

THE MAIN purpose of timing charts is to assist in determining whether or not doubtful control panel wiring will function without damaging the machine internally. A good working knowledge of the machine is necessary before timing charts can be used effectively. The timing charts should be used in conjunction with the control panel summary and operating suggestions in this manual.

Timing charts show in degrees or cycle points the time that exit hubs emit, and entry hubs accept impulses. Two timing charts are shown. The Type 412-418 chart shows operation when the accounting machine is used independently, or as the controlling unit of the CPC. The Type 527 chart shows control panel operation when the Type 527 and 605 are used independently as a calculating punch.

One functional cycle of machine operation is shown on the Type 412-418 timing chart. A cycle is defined as the period of time required to complete a given series of events, at the end of which the series is repeated. Thus, a functional cycle starts with the degree time from the beginning of the series of events rather than the beginning of a machine cycle. In operating the CPC there are two kinds of Type 412-418 cycles that are of most interest; card cycles and program cycles. Calculate time occurs during both types of cycles; thus, calculating can be performed on card cycles, program cycles, or special program cycles.

The Type 527 timing chart includes two cycles to illustrate functions occurring on any cycle that were brought about by conditions recognized during calculate time or during the previous machine cycle.

NOTES FOR 412-418 ACCOUNTING MACHINE TIMING CHART

1. If the calculation is not finished at unfinished program test time, the 412-418 goes into idle cycles, and calculate time continues until completed.
2. Card count emits only when the card is at third reading.
3. There are two kinds of card cycles hubs. The 5 hubs in the upper left corner are "all card cycles hubs." The other 11 hubs are "card cycles except head control" hubs.
4. Except overflow cycles.
5. Caused by sensing a 12 hole in tape. Ineffective when sensed during a skip.
6. The negative and 10 impulses are emitted when a negative number is on the channel. The complement and 9 impulses are emitted when a complement number is on the channel.
7. Caused by an impulse into the tens position of its respective channel control hub (A, B, C).
8. Special feature; available only when installed on machine.
9. Available only when a complement impulse is on its respective channel.
10. Except when total hub is impulsed.
11. Active on all cycles except card-feed-hold cycles.
12. Active when a negative number is read out.
13. This hub emits on minor body first card cycles if heading cards are used. If heading cards are not used, it emits on minor first card cycles.
14. First card in and last card out.
15. Active on the cycle the selector is transferred.
16. Active on all cycles if NBAC switch is jack-plugged.
17. When respective total hub is impulsed.
18. Active on cycle following calculate time when a zero test of the 605 counter found a non-zero balance.
19. When C carry entry and total hubs are impulsed on the same cycle, carry does not go beyond the units position.
20. Must be impulsed for the complete cycle.
21. Effective for overflow except for simultaneous skip to 1 or head control pickup. Action delayed for program cycles and for space suppression when impulsed from coupling exits.
22. A 10 or 11-12 impulse places a 5 in the sign position of a 941 storage register to designate that a negative number has been stored. A 258° to 270° impulse places a 9 in the sign position of a

412-418 ACCOUNTING MACHINE

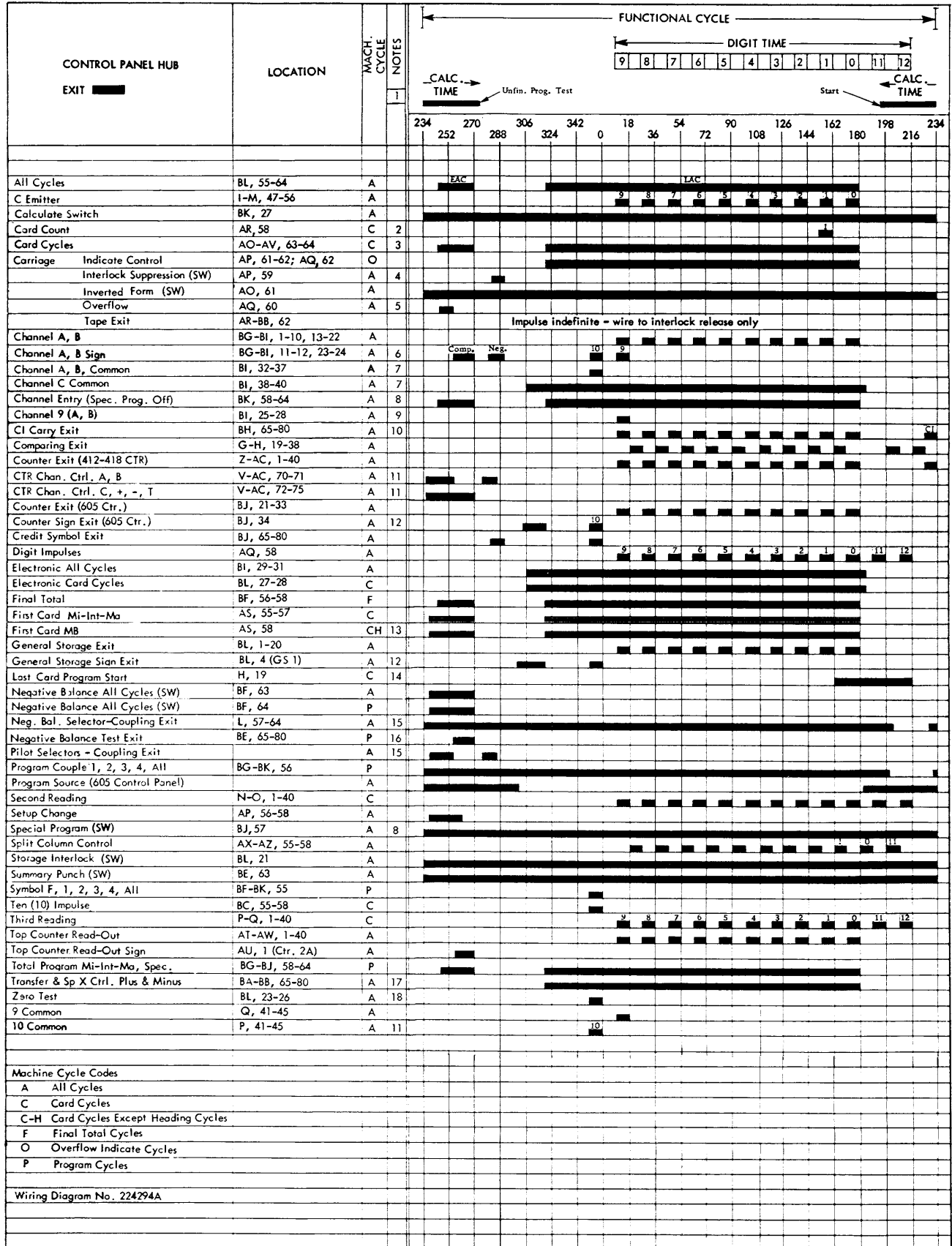

- Machine Cycle Codes
- A All Cycles
 - C Card Cycles
 - C-H Card Cycles Except Heading Cycles
 - F Final Total Cycles
 - O Overflow Indicate Cycles
 - P Program Cycles

Wiring Diagram No. 224294A

FIGURE 99. TYPES 412-418 TIMING CHART—EXIT HUBS

412-418 ACCOUNTING MACHINE

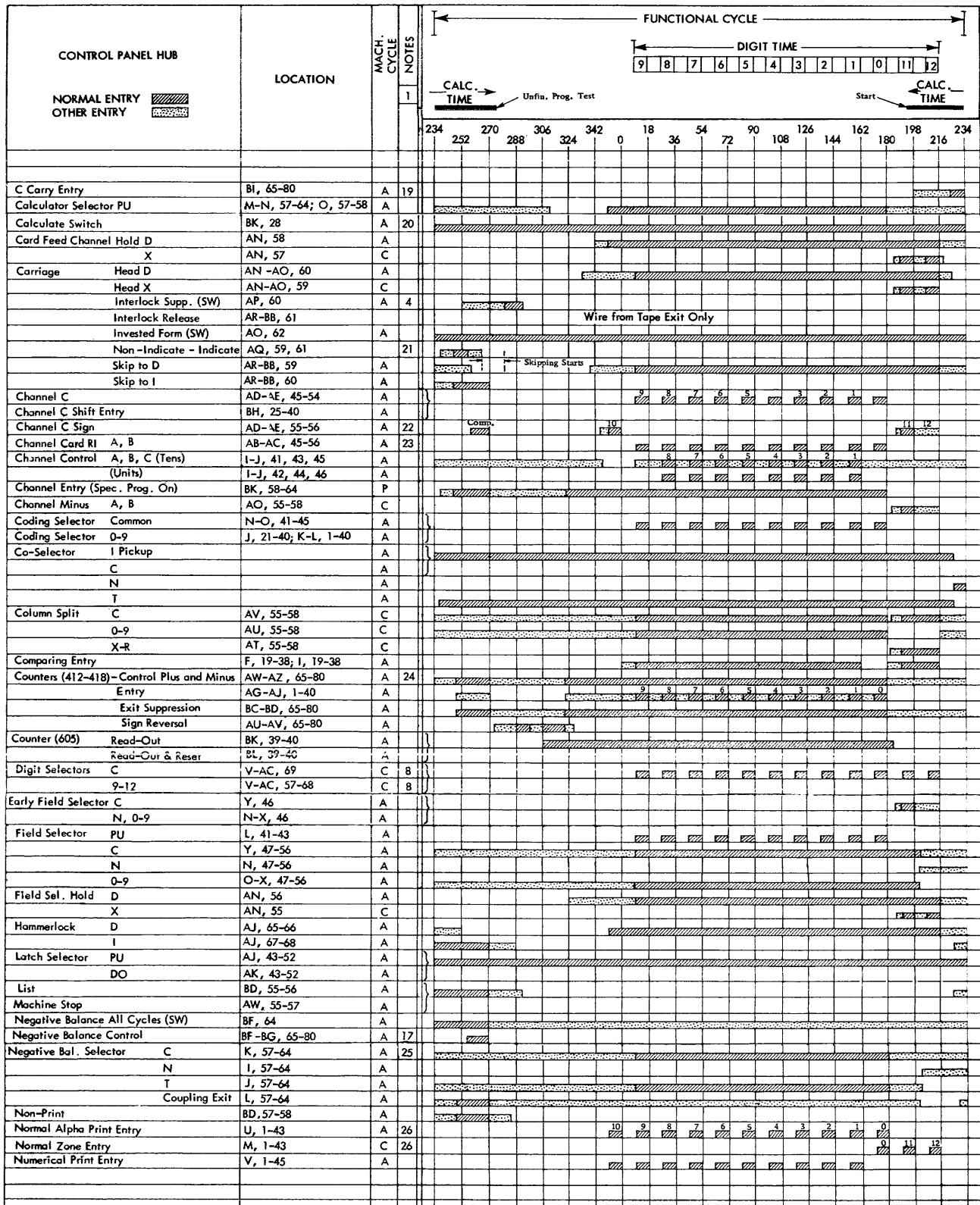
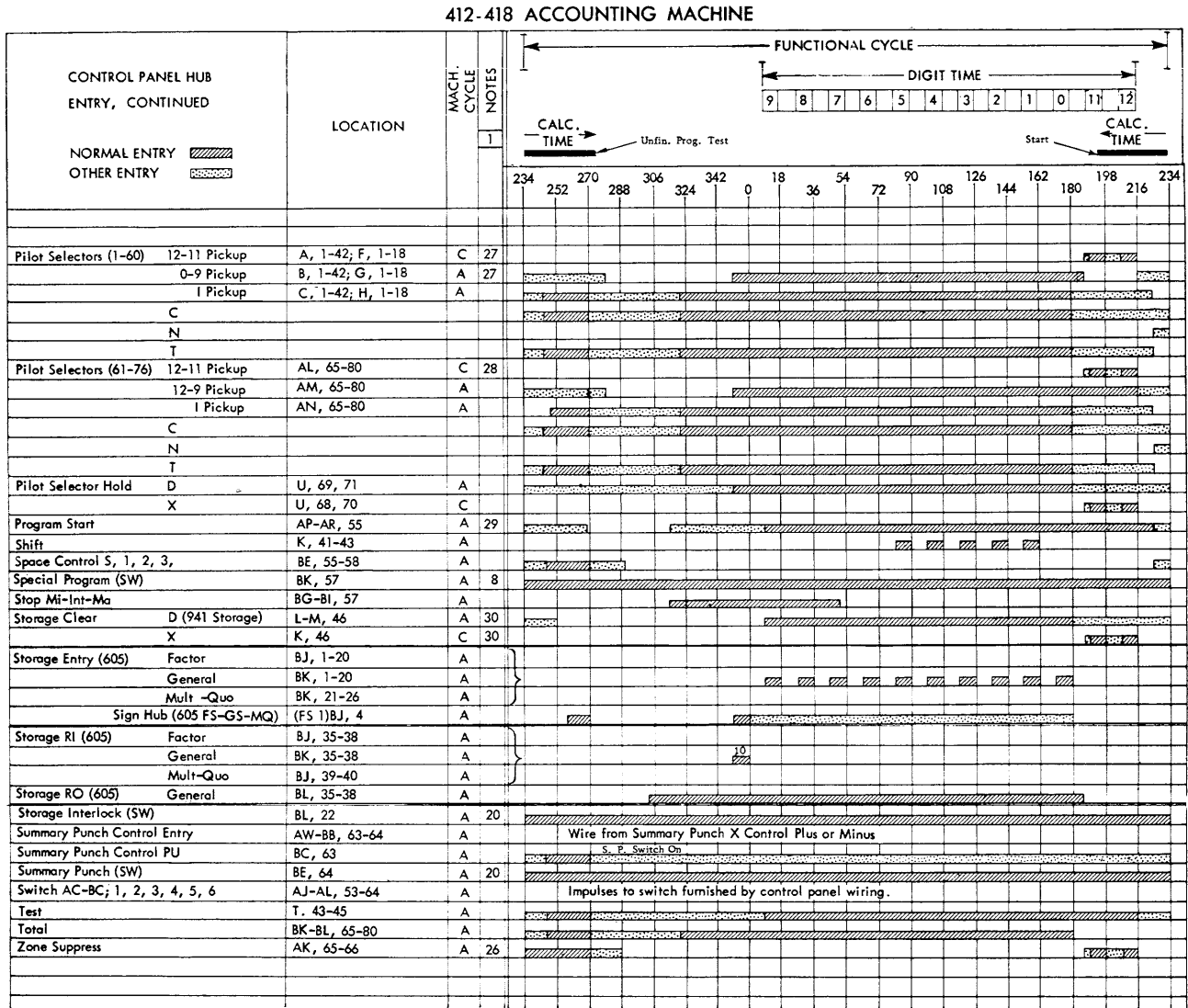

FIGURE 100A. TYPES 412-418 TIMING CHART—ENTRY HUBS



- 941 storage register to designate that a complement number has been stored.
23. Available as entries when the tens position of the respective channel control receives a O impulse.
 24. Except during summary punch cycles.
 25. Selector picked during calculate time by Bal. Test for Sel. PU if the 605 counter is negative on that program step.
 26. On 412 machine only.
 27. When 0-9 or 12-11 pickup is impulsed, the selector transfers for the next cycle only. However, the selector will remain transferred through intervening program cycles if pilot selector hold is also impulsed.
 28. These operate as standard Type 402 pilot selectors.
 29. If impulsed between 246° to 270° , the EAC portion of card cycles will emit on minor program, but the EAC of minor program and minor program couple will not emit.
 30. Must be accompanied by an impulse into tens position of channel C control to designate bank to be cleared.

TYPE 527 CALCULATING PUNCH

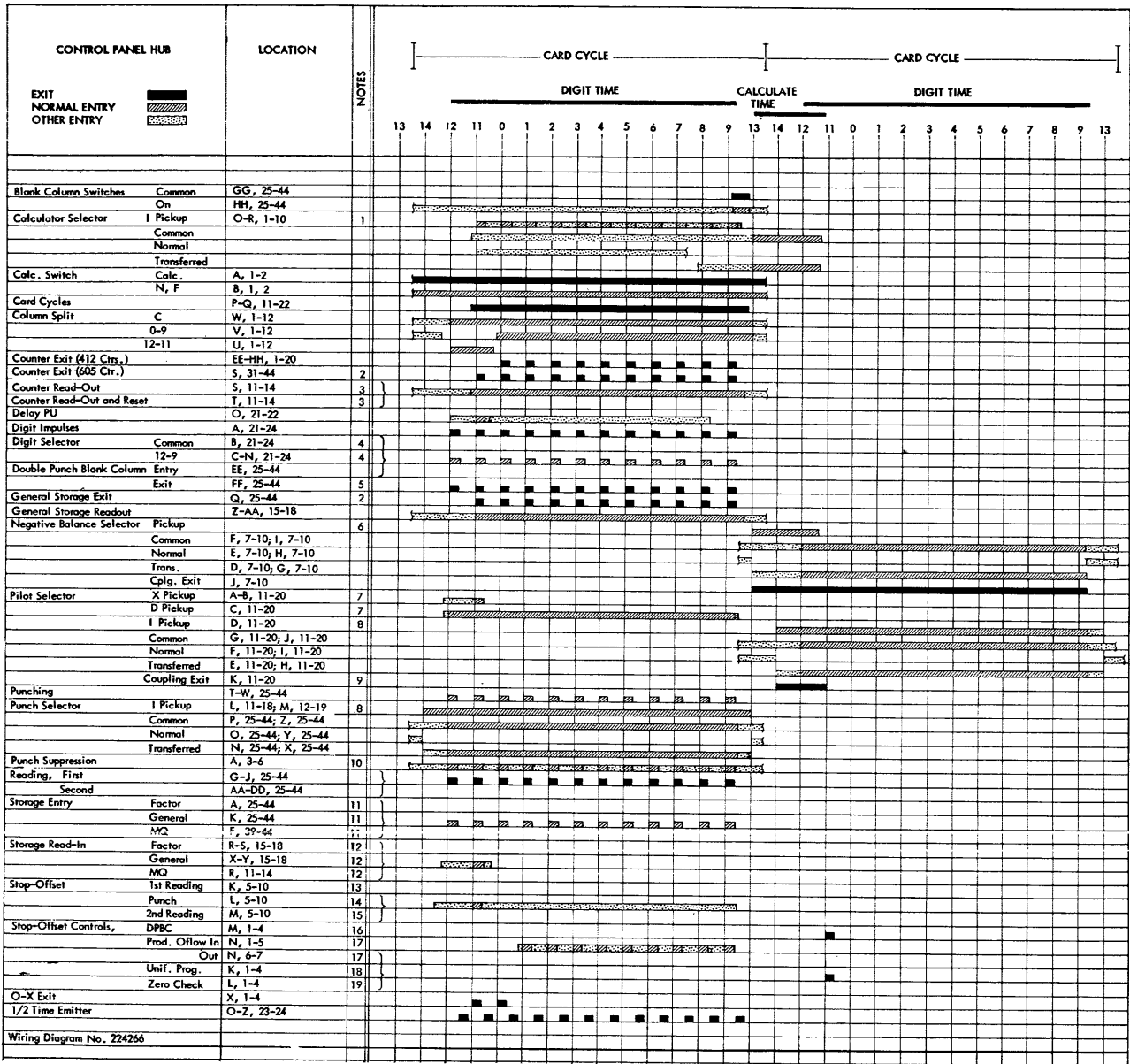

FIGURE 101. TYPE 527 TIMING CHART

NOTES FOR 527 CALCULATING PUNCH TIMING CHART

1. Impulsed during digit time (12-9) to transfer the selector for calculating time of that card.
2. Impulse emitted by each exit position is dependent upon the digit stored when impulsed to read out. In addition, the units position also emits an 11 (X) impulse if the number read out is negative. The sign hub emits impulses 11 through

9 when a negative number is read out. When a general storage unit is wired to read in for some cards and punch (read out) for others, a selector is required not only to control storage read in and storage read out, but also to select general storage exits to the punch magnets. If general storage exits are wired directly to the punch magnets, X's will punch whenever storage read in is impulsed.

3. Only card cycles impulses should be wired to these hubs.
4. Only digit timed impulses (12-9) should be wired to a C of a digit selector. C and 12 are common at 12 time; C and 11 are common at 11 time, etc.
5. Only the first impulse read into the DPBC entry hub is emitted from the corresponding exit hub.
6. Impulsed on the calculator control panel from a program exit to transfer the selector if the counter is negative. The selector transfers immediately but is only used during card time.
7. When the X and D pickup hubs are impulsed, the selector transfers for the next cycle.
8. When the I pickup is impulsed, the selector transfers immediately and remains transferred for the rest of that cycle.
9. If X or D pickup is impulsed, the coupling exit emits when the selector transfers. Coupling exit and I pickup are common.
10. When impulsed, all punching is suppressed for the following cycle.
11. The units position will accept 11 (or 12) impulses to cause a negative sign to be stored. The sign hub will accept any impulse from 12 through 9 to cause a negative sign to be stored. These are entries when the 605 and 527 machines are being used independently. They cannot be used as entries when the 412-418 machine is controlling the CPC.
12. Storage read-in will accept an 11 impulse, or the 11 portion of a card cycles impulse. An X impulse read from a card should not be used to impulse read-in when overpunched X's can reach the storage entry hubs. If an X impulse is used to impulse storage read-in, overpunched X's must be eliminated through column splits.
13. When this stop hub is impulsed, the machine will complete that cycle and two more before stopping. The offset stacker feature is optional.
14. When this hub is impulsed, the machine will complete that cycle and one more before stopping.
15. When this hub is impulsed, the machine will complete that cycle and stop.
16. The X impulse is emitted on the cycle following the one in which the error was detected.
17. Wired from 605 counter or GS exit position, which should be zero. If a digit 1 through 9 is present, the Out hub will emit an X impulse on the following cycle.
18. The X impulse is emitted when the available calculating time is not sufficient to complete the problem.
19. The X impulse is emitted immediately following the calculation in which the counter was non-zero.

INDEX

Addition	31	Delay Pickup (527)	101, 126
All Cycles (412-418)	119	Determining Machine Speed	113
Asterisk Symbol	119	Digit Impulse (DI)	120, 127
Balance Test	124	Digit Selector	
Balance Test for Selector Pickup	124	412-418	118
Blank Column Switches	126	527	127
Bus	118, 121, 127	Divide	123
Calculator Selector	29, 56, 118, 121, 126	Division	34
Coupling Exit	56, 111, 121	Double Punch and Blank Column	126
Calculate Switch		Entry-Exit	124
412-418	24, 117	Dual Feed Carriage	71
527	127	Early Field Selector	37, 118
Card Count	120	Electronic All Cycles	24, 117
Card Cycles (412-418)	120	Electronic Card Cycles	28, 117
Card Cycles (527)	126	Emit (1 through 9)	123
Card Feed Channel Hold	104, 118	Factor Storage	
Carriage Skip	120	Entry (412-418 Panel)	23, 117
Carry (Exit, Entry)	121	Entry (527 Panel)	124
Chain Wiring (605)	25	Read In (412-418 Panel)	24, 117
Channel A and B	45, 106, 115	Read In (605 Panel)	124
Channel A and B Card Read In	47, 118	Read In (527 Panel)	126
Channel A and B Common	46, 117	Read Out	124
Channel A and B Control	117	Field Selector	35, 102, 117, 118
Channel C	42, 49, 118	Field Selector Hold	36, 118
Channel C Common	43, 117	Final Total	119
Channel C Control	42, 117	First Card (MI, INT, MA, MB)	119
Channel C Shift Entry	49, 117	First Reading	124
Channel Entry	120	First Reading Stop-Offset	126
Channel Minus	47, 118	General Storage	
Channel 9	104, 117	Entry (412-418 Panel)	117
Channel Shift	51, 123	Entry (527 Panel)	124
Coding Selector	29, 115, 117	Exit (412-418 Panel)	117
Column Split		Exit (527 Panel)	124
412-418	119	Read In (412-418 Panel)	117
527	126	Read In (605 Panel)	124
Comparing		Read In (527 Panel)	126
Entry	115	Read Out (412-418 Panel)	117
Exit	115	Read Out (605 Panel)	124
Component Units, Functions of	8	Read Out (527 Panel)	126
Continuous Emitter	29, 118	Group Suppression	61, 123
Control Panel		Half Adjust	123
412-418	17, 18, 21, 116	Half Time Emitter	101, 126
605	19, 20, 122	Hammerlock	120
527	20, 22, 125	Head (X, D)	119
Control Panel Summary		Heat Dissipation	12
412-418	115	Indicate	120
605	121	Indicate Control	120
527	124	Indicator Lamp Panel	16
Co-selectors	52, 115	Interlock Release	120
Counter (412-418)		Interlock Suppression	120
Control Plus-Minus	121	Inverted Form	120
Entry	115	Latch Selector	55, 118
Exit (412-418 Panel)	70, 106, 115	List	119
Exit (527 Panel)	126	Machine Stop	119
Exit Suppression	121	Multiplication	27, 31
Sign Reversal	104, 120	Multiplier Quotient	
Top Counter Read Out	39, 106, 115	Entry (412-418 Panel)	24, 117
Counter (605)		Entry (527 Panel)	124
Exit (412-418 Panel)	24, 117	Read In (412-418 Panel)	24, 117
Exit (527 Panel)	124	Read In (605 Panel)	123
Read In Plus-Minus	123	Read In (527 Panel)	126
Read Out (412-418 Panel)	117	Read Out	123
Read Out (605 Panel)	123	Multiply (Plus-Minus)	123
Read Out (527 Panel)	126	Negative Balance All Cycles	120
Read Out and Reset (412-418 Panel)	24, 117	Negative Balance Control	121
Read Out and Reset (605 Panel)	123	Negative Balance Selector (412-418)	70, 118
Read Out and Reset (527 Panel)	126	Negative Balance Selector (527)	127
Reset	123	Negative Balance Test Exit	106, 121
Counter Channel Control	103, 121	Nine, Common	118
Couple	119	Non Indicate	120
Coupling Exit		Non Print	119
Calculator Selector	56, 111, 121	Normal Alphanumerical Print Entry	115
Negative Balance Selector (412-418)	118	Normal Zone Entry	115
Negative Balance Selector (527)	127	Numerical Print Entry	115
Pilot Selector (412-418)	115	Operating Suggestions	108
Pilot Selector (527)	127	Overflow	120
Credit Symbol Exit	121		

INDEX (continued)

Pilot Selector (412-418)	29, 52, 115	Storage Register Code	41
Pilot Selector (527)	127	Subtraction	32
Pilot Selector Hold	52, 121	Summary Punch Control Entry	112, 120
Power Requirements of CPC	12	Summary Punch Switch	101, 120
Power Supply Connections	108	Suppress	
Product Overflow	126	On Minus	124
Program Exit	24, 124	On Non Zero	123
Program Expansion	30, 123	On Plus	124
Program Pickup	25, 121	On Zero	123
Program Repeat	57, 123	Without Test	124
Program Repeat Selector	57, 123	Suppression Filter	61, 121
Program Source	25, 121	Switch (1-6)	118
Program Source Filter	60, 109, 121	Switches and Signals, Buttons, Lights, Keys	
Program Start	118	412-418	13
Program Suppression Entry	60, 112, 123	527	14
Punching	124	605	16
Punch Selector	124, 127	Symbol	
Punch Stop-Offset	126	Asterisk	119
Punch Suppress	127	Credit	121
Read Units (Into, Out of)	25, 123	Tape Exit	120
Repeat Delay	57, 123	Ten	119
Repeat Selector Pickup	57, 123	Ten Common	24, 118
Reset (605 Counter)	31	Test	70, 118
Second Reading		Third Reading	115
412-418	115	Timing Chart (412-418)	129
527	124	Timing Chart (527)	122
Second Reading Stop-Offset	126	Top Counter Read Out	39, 106, 115
Set Up Change Switch	119	Total	121
Shift (Channel C)	49, 117	Total Program	120
Sign Control Summary	106	Transfer and SP X Control	121
Space Control	119	Unfinished Program	126
Special Program	102, 119	Weight Requirements of CPC	12
Specifications of CPC Components	12	Zero Check (527)	126
Split Column Control	119	Zero Test	62, 117, 123
Stop (Minor, Intermediate, Major)	119	Zero-X Exit	126
Storage Assignment	62, 124	Zone Suppress	120
Storage Clear	48, 118		
Storage Interlock	42, 117		

